

# **GSI / Top Dry**

## **2003**

### **Service School**



PNEG-1314



a division of

---

**THE GSI GROUP**

---



# Contents

<b>Safety Pages.....</b>	<b>4</b>
<b>Product Updates.....</b>	<b>7</b>
<b>Software Revisions.....</b>	<b>11</b>
<b>Batch Troubleshooting.....</b>	<b>19</b>
<b>Autoflow Troubleshooting..</b>	<b>25</b>
<b>Diagnostics.....</b>	<b>32</b>
<b>Warranty.....</b>	<b>40</b>



## Roof Damage Warning and Disclaimer



GSI DOES NOT WARRANT ANY ROOF DAMAGE CAUSED BY EXCESSIVE VACUUM OR INTERNAL PRESSURE FROM FANS OR OTHER AIR MOVING SYSTEMS. ADEQUATE VENTILATION AND/OR "MAKEUP AIR" DEVICES SHOULD BE PROVIDED FOR ALL POWERED AIR HANDLING SYSTEMS. GSI DOES NOT RECOMMEND THE USE OF DOWNWARD FLOW SYSTEMS (SUCTION). SEVERE ROOF DAMAGE CAN RESULT FROM ANY BLOCKAGE OF AIR PASSAGES. RUNNING FANS DURING HIGH HUMIDITY/COLD WEATHER CONDITIONS CAN CAUSE AIR EXHAUST OR INTAKE PORTS TO FREEZE.

## Operating Instructions

The principal concern of the GSI Group, Inc. ("GSI") is your safety and the safety of others associated with grain handling equipment. This manual is written to help you understand safe operating procedures, and some of the problems that may be encountered by the operator or other personnel.

As owner and/or operator, it is your responsibility to know what requirements, hazards and precautions exist, and to inform all personnel associated with the equipment, or who are in the fan area. Avoid any alterations to the equipment. Such alterations may produce a very dangerous situation, where serious injury or death may occur.

## Safety Alert Symbol

The symbol shown is used to call your attention to instructions concerning your personal safety. Watch for this symbol; it points out important safety precautions. It means "ATTENTION", "WARNING", "CAUTION", and "DANGER". Read the message and be cautious to the possibility of personal injury or death.

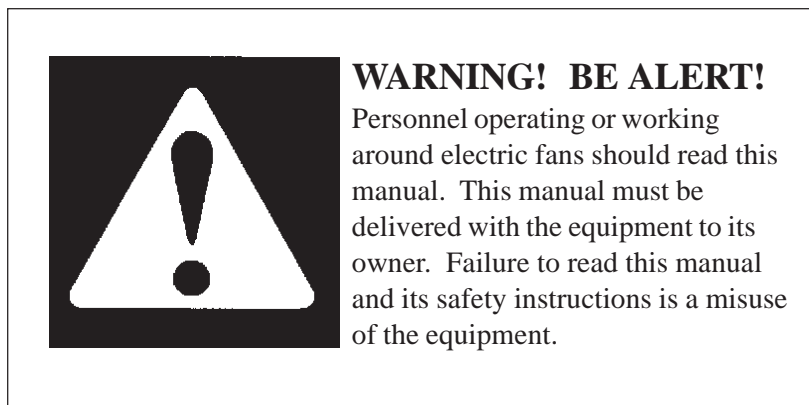

## 2003 Top Dry Service School

Grain Systems, Inc.

recommends contacting your local power company, and having a representative survey your installation so the wiring is compatible with their system, and adequate power is supplied to your unit.

Safety decals should be read and understood by all people in the grain handling area. The rotating blade, fire warning decals and voltage danger decal must be displayed on the fan can. The bottom right decal should be present on the inside bin door cover of the two ring door, 24" porthole door cover and the roof manway cover.

If a decal is damaged or is missing contact:

Grain Systems, Inc.  
1004 E. Illinois St.  
Assumption, IL 62510  
217-226-4421

A free replacement will be sent to you.



**! WARNING**

Stay clear of rotating blade. Blade could start automatically. Can cause serious injury. Disconnect power before servicing.

DC-1225



**! WARNING**

Flame and pressure beyond door. Do not operate with service door removed. Keep head and hands clear. Can cause serious injury.

DC-1227



**! DANGER!**

High voltage.  
Will cause serious injury or death.  
Lockout power before servicing.

DC-1224

**! DANGER!**



Automatic equipment can start at anytime. Do not enter until fuel is shut off and electrical power is locked in off position. Failure to do so will result in serious injury or death.

DC-973

**READ THESE INSTRUCTIONS  
BEFORE OPERATION AND SERVICE  
SAVE FOR FUTURE REFERENCE**

1. Read and understand the operating manual before trying to operate the dryer.
2. Power supply should be OFF for service of electrical components. Use CAUTION in checking voltage or other procedures requiring power to be ON.
3. Check for gas leaks at all gas pipe connections. If any leaks are detected, do not operate the dryer. Shut down and repair before further operation.
4. Never attempt to operate the dryer by jumping or otherwise bypassing any safety devices on the unit.
5. Set pressure regulator to avoid excessive gas pressure applied to burner during ignition and when burner is in operation. Do not exceed maximum recommended drying temperature.
6. Keep the dryer clean. Do not allow fine material to accumulate in the plenum or drying chamber.
7. Use CAUTION in working around high speed fans, gas burners, augers and auxiliary conveyors which START AUTOMATICALLY.
8. Do not operate in any area where combustible material will be drawn into the fan.
9. Before attempting to remove and reinstall any propellor, make certain to read the recommended procedure listed within the servicing section of the manual.
10. Clean grain is easier to dry. Fine material increases resistance to airflow and requires removal of extra moisture.

**This product is intended for the use of grain handling only. Any other use is considered a misuse of the product.**

**Some edges of the product components can be sharp. It is recommended that each component of this product be examined to determine if there are any safety considerations to be taken. Any and all necessary personal protective equipment should be worn at all times when handling, assembling, installing and operation of the product and/or components.**

**Guards are removed for illustration purpose only. All guards must be**

**Use Caution in the  
Operation of this  
Equipment**

The design and manufacture of this dryer is directed toward operator safety. However, the very nature of a grain dryer having a gas burner, high voltage electrical equipment and high speed rotating parts, does present a hazard to personnel, which can not be completely safeguarded against, without interfering with efficient operation and reasonable access to components.

Use extreme caution in working around high speed fans, gas-fired heaters, augers and auxiliary conveyors, which may start without warning when the dryer is operating on automatic control.

**KEEP THE DRYER CLEAN  
DO NOT ALLOW FINE  
MATERIAL TO ACCUMULATE  
IN THE PLENUM CHAMBER  
OR SURROUNDING THE OUT-  
SIDE OF THE DRYER**

Continued safe, dependable operation of automatic equipment depends, to a great degree, upon the owner. For a safe and dependable drying system, follow the recommendations within this manual, and make it a practice to regularly inspect the operation of the unit for any developing problems or unsafe conditions. Take special note of the safety precautions listed above before attempting to operate the dryer.

# **GSI / Top Dry**

## **Product Updates**

- \* **Adjustable Drying Chamber High Level Rotary Switch**
- \* **Plenum Hi-Limit**
- \* **Software Updates**

## DRYING CHAMBER HILIMIT ROTARY SWITCH INSTALLATION

Assemble 1/4" shaft to rotary switch with 1/4" coupler and rolled pins. Next Screw 1-1/4" pipe coupler to bottom of rotary switch. Insert 1-1/4" pip through adjustable roof mount weldment. Leave 1-1/4" pipe sticking out the top of the weldment 3" as shown in Diagram. Install paddle to 1/4" shaft assembly with coupler and rolled pins. Switch assembly is now ready to mount to roof.

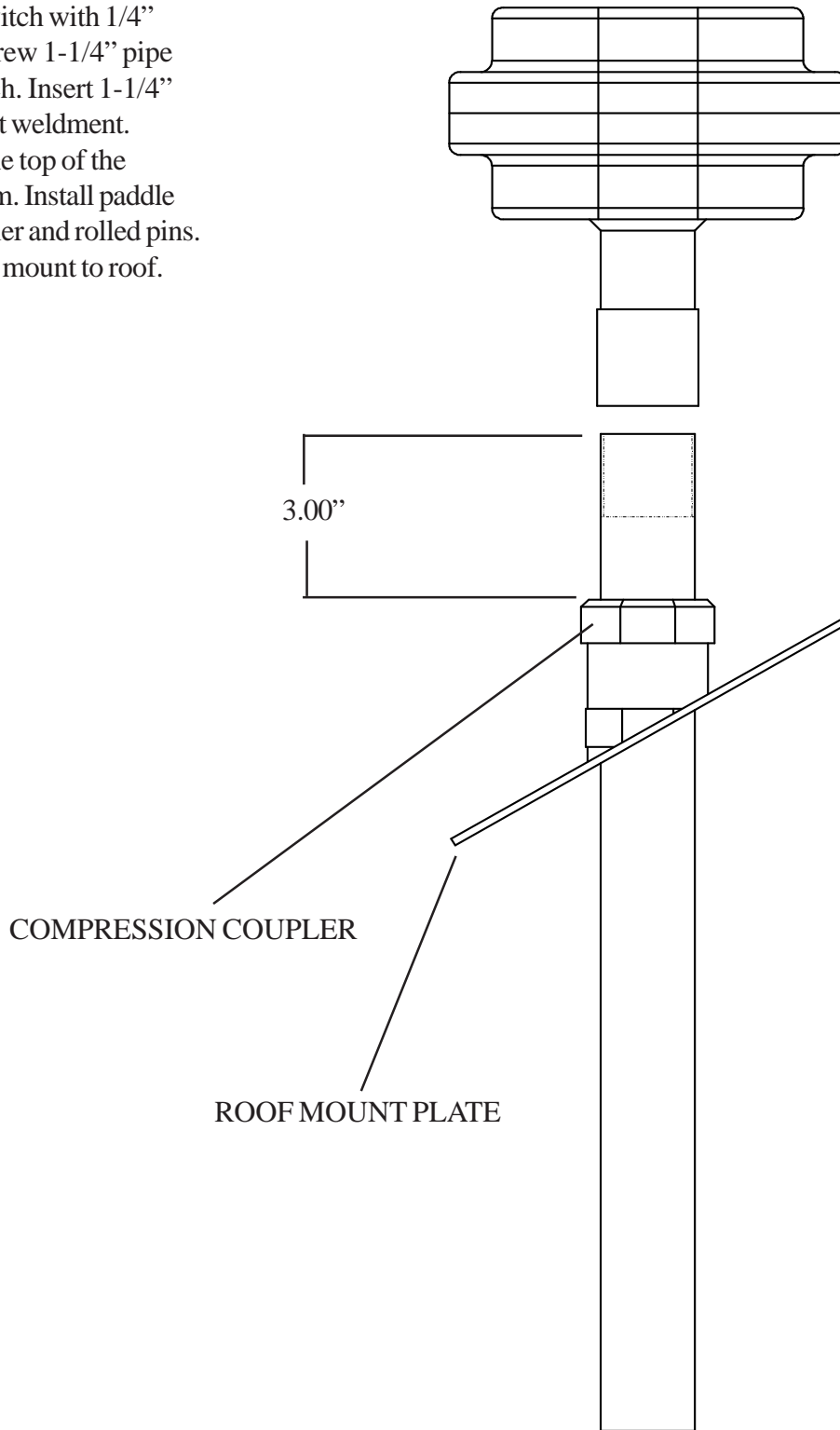



### TOP DRY PLENUM HI LIMIT INSTALLATION

1. Assemble two pieces of conduit together with coupler.
2. Mount conduit clamps to conduit assembly.
3. Locate conduit assembly on the bottom of a rafter at least 2 feet to one side of the fan entrance. Do not install between two fan entrances.
4. Mark bin wall where conduit will pass through and drill a hole just large enough to allow the conduit to pass through. Seal this with caulking when complete.
5. Install white PVC box assembly on outside of bin wall.
6. Insert 10' capillary into conduit assembly.
7. Connect SJO cord to hi limit and connect wires to terminals 20 and 21 on the master fan terminal strip. These terminals are J7-08, and J7-03.

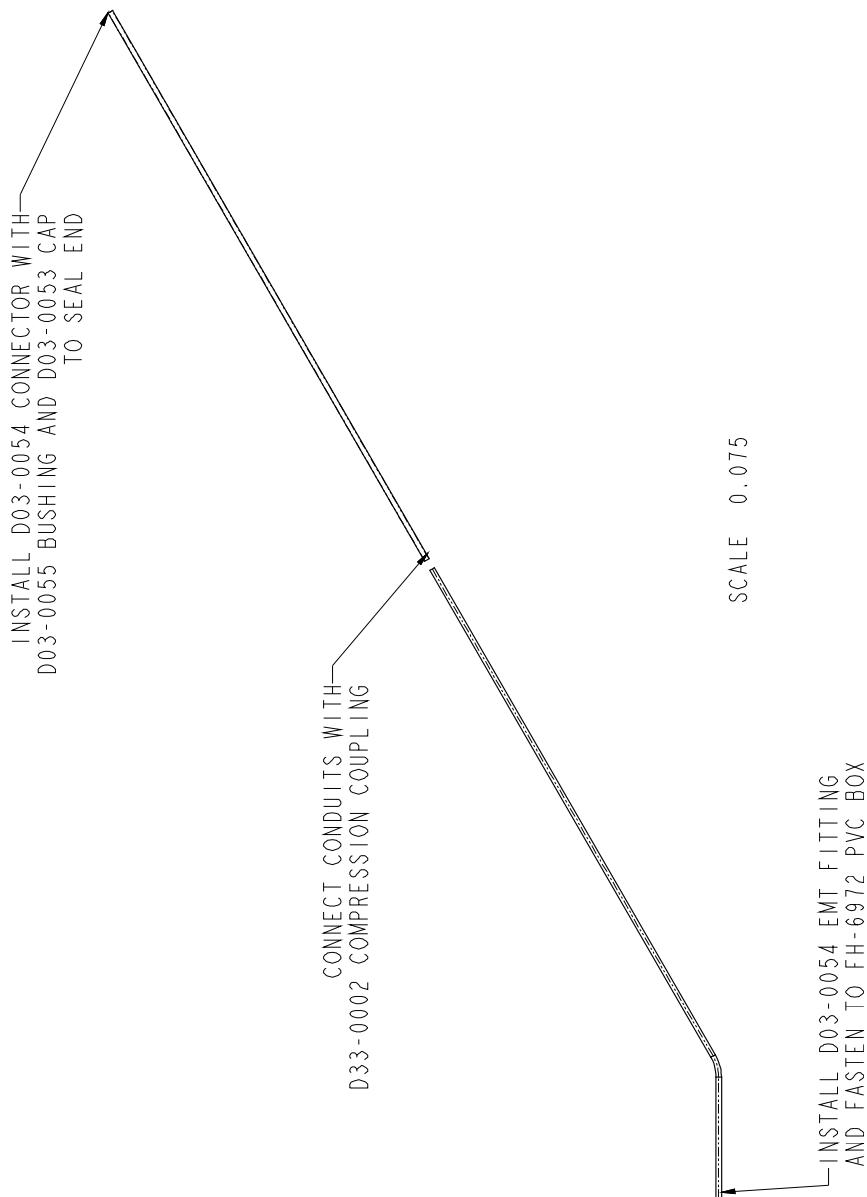

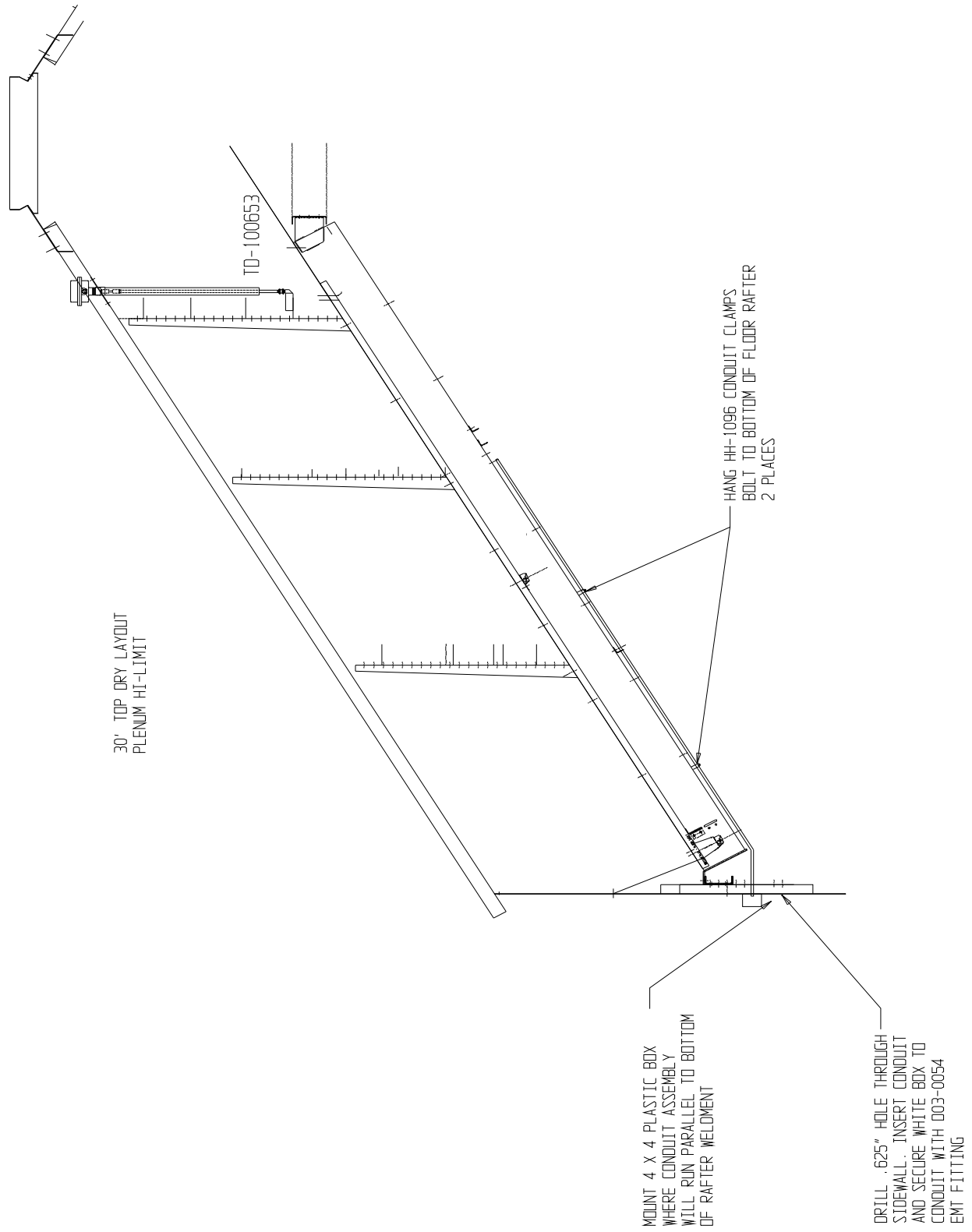

# **GSI / Top Dry Software Revisions**

Network Autoflow Display Board Software Revisions

\*\*\*\*\*

VERSION: 2.15 REVISION BY: Steve Logue RELEASE DATE: Oct 17, 2002  
NOTE: This Version does NOT support Watchdog and the Heater Version MUST be 1.09. HEATER VERS – 1.09 IO  
VERS – 1.07

- 1) The "FAN DELAY" is now called "MOTOR DELAY".
- 2) Added a way for GSI to reset total hours.
- 3) Here is a list of switches/features which can be found under the setup screens accessed via **holding in on MODIFY while powering on the Control Power**.  
Below is a description for each defining what it means to disable/enable them:
  - i) **AIRSWITCH** -> Enabled means you will get a shutdown when a fan loses airflow. Disabled will satisfy the dryer's airflow requirements for the burner regardless of the actual air switch state.
  - ii) **LOW LEVEL SWITCH** -> Enabled means the drying chamber low level switch will act as normal, i.e., will indicate the real state of the rotary switch.  
When disabled the dryer will think the low level switch is always covered.
  - iii) **WET TANK SWITCH** -> Enabled means this switch will act as normal. Disabled means the dryer will think this switch is always covered with grain.
  - iv) **START FANS WITH HIGH** -> Enabled means the dryer will start fans according to state of drying chamber hi level switch. Disabled means dryer will start according to drying chamber low level switch.
  - v) **AERATION FAN BYPASS** -> Enabled means the BYPASS is active, which allows the aeration fan to continue to run after a dryer shutdown.
- 4) The **REFILL TIMER** and the **TIME UNTIL LOAD OFF** screens are only shown when the dryer is set for **Autobatch mode**.
- 5) There are two more settings available under the "Power on and Modify key in" sequence **for the user to set** how many degrees a measured temperature can exceed a setpoint without causing an overheat. The user can set **10 -> 50 degrees** above the setpoint to be an overheat condition. The default for the **plenum temp is 20F** and the default for the **grain temp is 30F**.
- 6) The low level rotary switch function is the same as it was in 2.14, but now instead of giving a warning which states "**DRY CHAMBER EMPTY**" when it becomes uncovered it gives "**LOW LEVEL SW EXPOSED**."
- 7) Added an **Out of Grain Timer**. The time value can be changed under the setup button. This timer starts whenever either fill systems is running and the load switch is in the auto position. The timer is reset when both load augers stop. If the timer runs out of time an **OUT OF GRAIN warning** is issued. The default is 20 minutes. Any time the value of this Timer is changed the new value takes effect immediately.
- 8) Changed warning for wet bin empty to state "**WET BIN SW EXPOSED**" instead of saying "**DRYER OUT OF GRAIN**".
- 9) Renamed "**FILL 1 DELAY**" to "**FILL SYSTEM #1**". Changed name of "**FILL 2 DELAY**" to "**HI LEVEL SW**". The HI LEVEL SW delay is always available on both one and two fill system dryers and is used to make sure the dryer is full so you don't get bogus shutdowns. The FILL SYSTEM #1 delay is only available when you are set for two fill systems and it is used to establish auger cleanout time.
- 10) If the **Storage Bin High Limit is detected as failed** (the N.C. pin and the N.O. pin from the switch are both reporting the same voltage, 0 or 12 volts) a warning is reported as "**BIN HI LIMIT SW BAD**".
- 11) If wet supply rotary switch becomes uncovered there is a timer which must expire before a warning is given. This timer/delay was called "**AUX 1 DELAY**", but is now termed "**WET BIN SW . delay**". It is found under the **DELAYS** key.
- 12) The time a user has to think about making a change to a timer/setpoint before it automatically proceeds to the next selection screen has been doubled.
- 13) Changed the name of delay/timer "**LOW LEVEL TIMER**" to "**LO LEVEL SWITCH**."
- 14) Enabled the "**START FANS WITH HIGH**" switch function. There was previously a screen available to select this function, but it was never active.
- 15) The **cool down timer is now set to the reload value of the cool timer** whenever any one of the four following shutdowns takes place:
  - i) Dry and Hold switch is turned on state.
  - ii) Grain falls away from wet bin supply switch.
  - iii) Storage chamber is full.
  - iv) Dryer is out of grain.
- 16) Fans Off Delay now defaults to 0 minutes instead of 1 minute and has an upper limit of 5 minutes. This delay can be found under the "delay" key.
- 17) The dryer functions the same whether the load switch is in auto or on, but the out of grain timer only times down while the load switch is in the auto position and one of the load augers is running.

\*\*\*\*\*

VERSION: 2.14 REVISION BY: Steve Logue RELEASE DATE: Sept 20, 2002  
NOTE: This Version does NOT support Watchdog and the Heater Version MUST be 1.09 not the Watchdog version 1.10.

- 1) Fixed software so the burner differential could be set to one degree and it would remain there after loss of power.

# 2003 Top Dry Service School

---

\*\*\*\*\*

- VERSION: 2.11 REVISION BY: Steve Logue RELEASE DATE: October 27, 2000
- 1) Burner differential would not stay at 1 deg F when the dryer was turn off, using 2.10, now it does.
  - 2) When grain reaches the Storage Chamber Rotary Switch, the dryer will enter a "Cool Down Mode". The fan will run and cool the grain for 10 minutes before shutting down due to a Storage Chamber Full error.
  - 3) When grain falls away from the Wet Supply Rotary Switch, the dryer will enter a "Cool Down Mode" after the fill system shut off. The fan will run and cool the grain for 10 minutes before shutting down due to a No Wet Supply error.
  - 4) When the Dry & Hold switch is placed in the "On" position the dryer will enter a "Cool Down Mode" for 20 minutes before stopping. This only happens at the end of the dry cycle.
  - 5) Corrected a problem with the Fans Off Delay. If there is time on this delay, the fans and heaters will shut off during the unload cycle, after the unload cycle is complete the delay counts down. The fans and heaters will not start again until the delay has reached zero.
  - 6) Corrected a problem with the Time Until Load Off percentage set in the set-up mode. Now, in Auto batch only, the Fill Systems will shut off if grain has not reached the dry chamber high level rotary switch within the set percentage of the dry timer is completed. Example: 1 hr dry time, 50% Time Until Load off. The fill systems will shut off regardless of rotary switch status after 30min has expired.
  - 7) Corrected a problem with the Refill Delay. Now, in Auto batch Only. The Refill Delay begins to count down after the unload cycle is completed. If grain has not reached the drying chamber low level rotary switch before this delay reaches zero, a dry chamber empty error is given.

\*\*\*\*\*

- VERSION: 2.10 REVISION BY: Steve Logue RELEASE DATE: Sept 11, 2000
- 1) Changed the Minimum Burner Differential to 1 Deg Fahrenheit
  - 2) Fixed the problem where the burner was not shutting off when the Dry & Hold switch was placed in the "On" position, the Dry Cycle was complete, and the Dryer was in the Cool Cycle. Now, when the Dry & Hold switch is placed in the "On" position, and the Dry Cycle is complete, the dryer will shut the burner off and will cool for the amount of time on the Cool Timer before stopping.
  - 3) Fixed a problem where the dryer was not shutting down with an "Out of Grain" error when the Wet Supply Rotary Switch was exposed. Now when the Wet Supply Rotary Switch is exposed, the Fill #1, and Fill #2 delay will count down and shut off Fill System #1 & #2, then the dryer will shut down with an "Out of Grain" error. If there is still grain against the Low Level Rotary Switch, the dryer can be restarted by pressing the Stop switch to clear the error, turning the Load Auger switch to the "Off" position, and pressing the Start switch. When the Start switch is pressed the screen will say "Press <Enter> to Dry Remaining Grain". If the <enter> button is pressed the dryer will restart. NOTE: If the Load Auger switch is left in the "Auto" position an "Out of Grain" error will be given on startup.

\*\*\*\*\*

- VERSION: 2.09 REVISION BY: Steve Logue RELEASE DATE: May 15, 2000
- 1.) Selection screen for On-Off burner. This cannot be used in conjunction with diesel burner.
- NOTE: Must change heater software also. Use following version number or higher: Heater ==> 1.09

\*\*\*\*\*

- VERSION: 2.08 REVISION BY: Steve Logue RELEASE DATE: May 12, 2000
- 1.) Changed the burner differential setup screen to correctly display Celsius temperatures.
  - 2.) Now only a year above 2000 may be entered upon setting the date.
  - 3.) Burner differential is now greater than 1 and less than 10 degrees.

\*\*\*\*\*

- VERSION: 2.07 REVISION BY: Steve Logue RELEASE DATE: April 25, 2000
- 1.) Changed the checksum method for the network to help insure data integrity.
  - 2.) Force aeration fan to start before drying fans start, unless aeration switch is in off position.
  - 3.) Load systems cannot start for five seconds after start of system.
- NOTE: Must change heater and I/O software also. Use following version number or higher:  
Heater ==> 1.07 IO ==> 1.07

\*\*\*\*\*

- VERSION: 2.06 REVISION BY: Steve Logue RELEASE DATE: April 20, 2000
- 1.) Stopped the ability to change the grain setpoint from heaters.

\*\*\*\*\*

- VERSION: 2.05 REVISION BY: Steve Logue RELEASE DATE: March 30, 2000
- 1.) Fixed a problem with fan 1 reporting air switch already engaged if fan 2 had not started yet.
  - 2.) Fixed the low level disabling software so a warning is not reported when the high level grain switch detects grain without the low level detecting grain.

\*\*\*\*\*

- VERSION: 2.04 REVISION BY: Steve Logue RELEASE DATE: Feb 25, 2000

# 2003 Top Dry Service School

---

\*\*\*\*\*

VERSION: 2.01 REVISION BY: Steve Logue RELEASE DATE: October 4, 1999

- 1) Attempted to fix the problem of grain setpoint changing by itself.
- 2) Fixed problem of batch dryer always shutting down with a "DRYING CHAMBER EMPTY" warning. A delay called the "REFILL TIMER" allows the dryer to fill back up.

\*\*\*\*\*

VERSION: 2.00 REVISION BY: Jeff Falconer RELEASE DATE: January 6, 1999

- 1) Fixed hour timer so dryer will now show running time of dryer.
- 2) Changed the way the dryer shut down when using the dry and hold switch, now it will cool the grain using the cool timer before it shuts down to prevent heat buildup of grain past the grain temp set points thereby causing a shutdown condition. Works in Autoflow and AutoBatch modes.
- 3) Fixed the clock to properly roll over in the year 2000.
- 4) Added a user batch count and user timer independent from the Total batch and Total time allowing monitoring of different users drying grain or different fields for comparison of drying time.
- 5) Added a test procedure for the keypad. Turning all of the control switches to the right (on position) and holding in the stop switch while turning on the control power activates it. User can now test each individual keypad switch for malfunction or stuck keys. (Taken out in 2.03)
- 6) Added control switch testing by pressing and hold the plenum and grain switches in while turning on the control power. This will allow the user to test for failed switches or computer failure to detect switch position changes. (Changed in 2.03 to turn power on with Help key depressed)
- 7) Removed garbage displayed when user selected to view total running time and total batches.
- 8) Added a check to make sure the dump switch is always in the Auto position. Otherwise if left in manual close will cause the dryer never to dump.
- 9) Fixed several bugs that were reported to use by users and dealers.
- 10) I added the ability to reset the Total Dryer running time by pressing the HOUR and RESET button together and turn on the dryer.
- 11) Removed watchdog option in Extended setup mode since watchdog has not been implemented yet.
- 12) Changed the wording to some of the error messages concerning the rotary switches to help eliminate some confusion of which switch was at fault.
- 13) Moisture control light will now flash to give a visual indication that the dryer is in temperature hold.

\*\*\*\*\*

VERSION: 1.06 REVISION BY: STEVE LOGUE RELEASE DATE: November, 98

- 1.) Fixed dryer so the grain hi limit occurs at 20 F above the grain temp setpoint.
- 2.) Made timeout on the open/close of the actuator 20 seconds instead of 15 seconds. This extra time was added to compensate for the weaker batteries taking longer to close the chutes.

\*\*\*\*\*

VERSION: 1.05 RELEASE DATE: September, 98

- 1.) Made the out of grain timer active.

\*\*\*\*\*

VERSION: 1.04 RELEASE DATE: July, 98

- 1.) The application of 12v to terminal number j1-20 will shutdown the dryer and give an indication that the bin is full due to the high level of static pressure within. "BIN AIR PRESSURE LIM" will be displayed on screen's top line until the user corrects the problem. (Originally looked for lack of 12v, fixed in 2.00)
- 2.) Corrected the hour meter problem.
- 3.) Changed how the dry timer is displayed: Now when the dry timer goes to zero it will begin counting upward at the user set time as long as the dryer remains in temp hold.

\*\*\*\*\*

VERSION: 1.03 RELEASE DATE: March, 98

- 1.) Added software to allow the aeration fan to continue running even if there was a dryer shutdown. The aeration fan BYPASS mode must be selected under setup.

\*\*\*\*\*

VERSION: 1.02 RELEASE DATE: Jan, 98

- 1.) The Bin high limit rotary switch is monitored in both states to insure that a switch failure has not taken place. If both switches are in the same state a switch failure is reported.

\*\*\*\*\*

VERSION: 1.01 RELEASE DATE: NO OFFICIAL DATE ASSIGNED

- 1.) Added burner differential adjustment to be set at master under extended setup.
- 2.) Gary Woodruff's software for holding the fans off during a portion of the dry cycle. This is adjusted under delays.
- 3.) Attempted to make the dryer dry remaining grain when a wet supply empty error takes place.
- 4.) Added software to display a negative incrementing counter, where the dry timer used to be, during temp hold. (Changed in 1.04)

\*\*\*\*\*

VERSION: 1.00 RELEASE DATE: SEPTEMBER 16, 1997

- 1.) We changed resistor number 107 on the display board from 10K to 3.0K to allow the contrast to work without resetting the computer.
- 2.) Put in a contrast adjustment for the display. While turning the control power on, hold in on the screens key, and this will enter the contrast adjustment mode. Now use the UP/DOWN arrow keys to adjust. If the screen is solid black press the down arrow key, if nothing appears on the screen press the up arrow keys. NOTE: You cannot hold in on the UP/DOWN arrow keys to adjust, you must continue to press and then release them or nothing will happen.
- 3.) Put Software in for 3<sup>rd</sup> Fan and Heater.

\*\*\*\*\*

VERSION: 0.05 RELEASE DATE: 1996

This was the first version released for customer operation. This particular version could only control 2 Fan and Heaters.

## Heater and Batch Top Dry Revisions

---

0.30 Released OCTOBER 23, 1998

1) FLAME TIME OUT IS NOW 10 SECONDS. THE IGNITOR SHUTS OFF IN ABOUT 7.5 SECONDS.

0.29 Released OCTOBER 22, 1998

1) ELIMINATE THE DEISEL OPTION -- FORCE THAT FLAG TO ALWAYS BE RESET. THIS CAUSED A 36 SECOND FLAG TIME OUT WHICH THE HARDWARE IS NOT SETUP TO ACCEPT. IF DEISEL OPTION IS REQUIRED AT SOME LATER DATE -- WILL HAVE TO MODIFY SOFTWARE TO REDUCE FLAME TIME OUT BACK TO 12 SECONDS MAX OR CHANGE THE HARDWARE.

2) DEFAULT FAN DELAY = 0 SECONDS ( FOR SLAVES )

0.28 Released August 24, 1998

1) CREATE O / noO FLAG -- FOR EITHER IGNITOR OR HOT SURFACE IGNITION -- WHEN SET THIS IS USED FOR A HOT SURFACE IGNITION SYSTEM -- SO THAT AT THE END OF THE PURGE DELAY THE IGNITOR COMES ON FOR 5 SECONDS BEFORE THE GAS VALVE TURNS ON. NOTE: I DID NOT USE I / noI BECAUSE IF THIS SOFTWARE WAS PUT ON AN OLD DRYER -- IT WOULD DEFAULT TO noI -- IF THEY DID NOTHING. SINCE H / noH IS ALREADY BEING USED FOR HUMIDITY -- I JUST USED O.

2) WHEN THE " O " FLAG IS SET -- AFTER THE 9 SECOND IGNITOR PERIOD THE IGNITOR DOES NOT TURN OFF  
3) IN THE " O " MODE A FLAME OUT CAUSE THE GAS VALVES TO GO OFF FOR 5 SECONDS WHILE THE HOT SUFACE IGNITION COMES ON. THE WAY I DID THIS WAS TO RESET THE PURGE TIMER TO 5 SECONDS -- SO ON THE DISPLAY THE " PURGE " COMES UP -- THIS WAS THE EASIEST WAY TO ACCOMPLISH THIS.

4) CREATE d / noD FLAG -- FOR DIESEL FIRED SYSTEM. THIS SYSTEM HAS NO PURGE DELAY ( ACTUALLY 1 SECOND PURGE ) AND A 36 SECOND FLAME OUT TIME.

??

SHOULD THERE BE A LITTLE MORE PURGE DELAY --- SAY 5 SECONDS INCASE SOMEONE ACCIDENTLY SET THE WRONG FLAG.

5) IF THE OPERATOR SET BOT THE " O " AND " d " FLAG THE " d " FLAG WILL NOT SET.

0.27 Released August 22, 1998

1) Fixed problem in the Non Top Dry where after 30 minutes Error 3 shut the dryer down.

0.26 Released April 29, 1998

1) CHANGE FLAME OUT TIME TO 12 SECONDS -- IGNITOR SHUTS OFF IN 9 SECONDS -- 3 SECONDS LATER IF NO FLAME -- SHUT DOWN -- NO FLAME. (CHANGED IN .30)

2) INCLUDE " FLAME " SYMBOL IN THE AMBIENT TEMPERATURE AND HUMIDITY MODES

3) ALLOW HUMIDITY DIFFERENTIAL TO BE SET TO 2 %

4) DONT DESTROY " MODE " REGISTER WHEN EXITING THE PROGRAM MODE

0.25 Released April 27, 1998

1) Add a mode select for the humidity and ambient temperature. Using the mode switch ( Fan bypass ).

C.24 ??????????????????????

C.23 Released OCTOBER 29, 1997

1) FIXED PROBLEM WHERE IF BOTH THE MASTER AND SLAVE HAVE THEIR OWN INDEPENDENT ERRORS -- THE SLAVE DOES NOT FLICKER BACK AND FORTH BETWEEN IT ERROR AND THE MASTER ERROR -- SLAVES ERROR HAS PRIORITY ON THE SLAVE UNIT AND THE MASTER HAS PRIORITY ON MASTER UNIT.

2) IF THERE IS AN INCONSISTANCY BETWEEN MASTER AND SLAVE ( ERROR 9, 10 OR 11 ) -- THE MASTER TRIES RESENDING THE IGNITOR COMMANDS 50 TIMES AND RECHECKING BEFORE ISSUING THE ERROR

b.23 Released OCTOBER 22, 1997

1) EXTEND THE IGNITOR ON TIME TO 14 SECONDS AND THE LAST 4 SECONDS SHUT THE IGNITOR OFF (changed in .26)

A.23 Released OCTOBER 15, 1997

1) ALLOW 20 SECONDS FOR ILLEGAL FLAME SENSE

SECONDS -- EXIT THE PROGRAM MODE.

0.22 Released OCTOBER 22, 1996

- 
- 1) FIXED THE PROBLEM WHERE IF YOU SET IN 3.2 HOURS -- THE HOURS IMMEDIATELY WENT TO .32 WHEN YOU EXITED THE PROGRAM MODE
  - 2) \*CLEARING OF THE NOVAM IS NOW ACCOMPLISHED BY POWERING UP WITH THE PROGRAM SWITCH HELD DOWN ( LOWER LEFT \*  
\*SWITCH ) -- WHEN THE " 0 " COMES UP -- ENTER A " 7 " WITH THE INCREMENT SWITCH -- THEN PUSH THE PROGRAM SWITCH AGAIN \*  
\* " - - - " COMES UP -- YOU HAVE 2 SECONDS TO DEPRESS THE INC DEC SWITCHES AT THE SAME TIME TO CLEAR THE NOVAM \*

0.21 Released OCTOBER 2, 1996

- 
- 1) FIXED THE PROBLEM THAT I CREATED IN VERSION # 0.20 WHERE THE ERROR 3 CAME ON -- SPARE TEMPERATURE OPEN
  - 2) WHEN IN TOP DRY MODE THE CYCLE FLAG IS ALWAYS SET

0.20 Released SEPTEMBER 12, 1996

- 
- 1) CREATE A NEW MODE THAT WILL MAKE IT SO THAT BOTH THE GRAIN TEMPERATURE MUST EXCEED THE LIMIT AND THE DRY TIME  
MUST BE EXCEEDED BEFORE ADVANCING TO THE COOL CYCLE ON THE TOP DRY
  - 2) IF THE GRAIN TEMPERATURE GETS TO 200 -- ALWAYS ADVANCE TO THE COOL CYCLE -- IN ALL MODES OF TOP DRY, ---> IF THE 10  
MINUTE GRAIN TIMER HAS GONE TO 0.
  - 3) FIXED PROBLEM ( I THINK ) WHERE THE TEMPERATURE WOULD MOMENTARILY JUMP UP TO 275 DEGREES -- WHEN THE THERMISTOR  
SWITCH-OVER OCCURED ON THE BOARD

0.19 Released JUNE 8, 1996

- 
- 1) HUMIDITY SOFTWARE

0.18 Released MARCH 13, 1996

- 
- 1) DON'T ADVANCE TO COOL CYCLE IN TOP DRY MODE FOR 10 MINUTES AFTER STARTING THE DRYER  
-- ALLOW THE GRAIN TEMPERATURE SENSOR TO STABILIZE
  - 2) WHEN THE SLAVE POWERS UP WITH THE FAN ON -- THERE WAS A LOT OF DISPLAY FLICKER -- CORRECT THAT PROBLEM

0.17 Released OCTOBER 17, 1995

- 
- 1) FIXED THE PROBLEM WITH THE TOP DRY MASTER NOT SHUTTING THE FAN OFF WHEN THE SLAVE GOT AN ERROR
  - 2) WHEN GETTING ONE OF THE LIMIT ERRORS, ETC -- THAT JUST DISPLAYS A LEGEND -- ON THE MAIN DISPLAY INSTEAD OF DISPLAYING  
TEMPERATURE -- **DISPLAY:           0 0 0**  
**ERROR**

0.16 Released OCTOBER 16, 1995

- 
- 1) Raised the Error 12 Voltage Limit from >155 to >195 volts for 120 volt systems. <155 volts still the error 12 limit for 240 volt systems.

0.15 Released OCTOBER 14, 1995

- 
- 1) CORRECTED THE PROBLEM WHERE WITH CERTAIN ERRORS YOU COULD NOT VIEW THE AMOUNT OF TIME THE DRYER HAS BEEN  
DOWN DUE TO ERROR CONDITION
  - 2) IF THE " STANDARD DRYER " ( NOT TOP DRY ) FINDS A SLAVE INCONSISTANCY ERROR -- ERROR # 9, 10 O 11 -- IT WILL TRY RESTARTING  
THE SLAVE FOR 5 SECONDS BEFORE IT GIVES UP
  - 3) CORRECTED THE BUG IN VERSION 14 SOFTWARE WHERE THE REMAINING HOURS WERE NOT STORED FOR DRY AND COOL TIME -- ALL



## 2003 Top Dry Service School

---

CAN VIEW THE HOURS THAT HAVE PASSES SINCE THE SHUT DOWN BEGAN. MAX NUMBER OF HOURS = 218 HOURS (9.1 DAYS) \*

- 2) ADDED ERROR NUMBER 13 ==>> + 11 LIMIT SHORTED
- 3) LIMIT MAX TEMPERATURE SETTING TO 230

0.11 Released AUGUST 16, 1995

- 
- 1) MAKE THE SPARE RELAY ACT THE SAME AS THE FAN RELAY -- BOTH OPEN AND CLOSE AT THE SAME TIME

0.10 Released July 12, 1995

- 
- 1) If the Heater shuts down due to a "Illegal Flame" Sensing problem – Flame on when no gas valves are on →Error 7. Leave the Fan on till that problem goes away. When the Heater Control detect No Flame – The Fans are Shut Down.

The Fans are left in the State they were in when the error was detected. That is – If the Error 7 occurs on the Power Up – Don't turn the Fans on – That must be due to some other problem.

In a Master / Slave heater – Only the Heater with the Flame since problem keeps it's fan on.

In the Timed Shut Down Modes the Fans are left on till it is confirmed that the Flame has gone away. This is for Top Dry and Regular Fan and Heater.

In the Top Dry when the Grain Temperature exceeds the limit – The Fans are left on till it is confirmed that the Flame has gone away.

0.09 Released May 27, 1995

- 
- 1) In all test modes shut the outputs off.
  - 2) ON May 31, 1995 -- changed the flash decode bytes to program the entire chip rather than the first 256 k bits -- left the version at 0.09

0.08 Released April 18, 1995

- 
- 1) Fixed the problem where when the humidity was too high or the grain temp was to high the display flash real fast.

0.07 Released Good Friday in the Year of Our Lord 1995

- 
- 1) Fixed the problem with the error not being displayed on the top dry remote.
  - 2) Allow the remote to reset the Cool and Dry timers if the Inc and Dec switches are depressed at the same time.

0.06 RELEASED 3/23/95

- 
- 1) IF THE HUMIDITY INPUT IS SHORTED TO + 11 VOLTS ADVANCE TO THE COOL CYCLE
  - 2) IF THE HUMIDITY IS TO HIGH TO BEGIN WITH -- THE D\_RH AND D\_PERCENT FLASH ON AND OFF FOR A FEW SECONDS

0.05 RELEASED 3/23/95

- 
- 1) ADDED WATCH DOG SOFTWARE

0.04 RELEASED 3/06/95

- 
- 1) FILTER THE FLAME PRESENT INDICATOR
  - 2) FILTER THE ERROR 12 -- WRONG VOLTAGE ERROR

0.03 RELEASED 12/05/94

- 
- 1) IN THE TOP DRY MODE WHEN AN ERROR OCCURS WHILE RUNNING -- EITHER COOL OR DRY TIME -- THE TIMER IS SAVED AND AFTER POWER OFF AND ON AND CORRECTING THE ERROR THE TIMER RESUME WHERE IT LEFT OFF.
  - 2) YOU CAN CLEAR THE TIMER BY DEPRESSING THE INC AND DEC SWITCHES AT THE SAME TIME.

### PROGRAMMABLE DELAY FOR TOP DRY FANS

The dry time and cool time " carrots " on the display both flash indicating -it is in the program delay time mode.--- NOTE: THIS CAN BE DONE ON THE MASTER

0.01 RELEASED 10/11/94

-----  
1) ADDED MODE TO ALLOW TOP DRY TO HAVE REMOTE PLUS 2 SLAVES

2) ADDED ERROR # 12 -- WRONG VOLTAGE ERROR

3) PUT REVISION LEVEL ON POWER UP SCREEN

\* 4) IF THE START SWITCH IS HELD IN THROUGH THE POWER UP SCREEN -- TILL AFTER THE VERSION NUMBER DISPLAY -- ALL SEGMENTS

LIGHT TO ENABLE EASIER DECAL ALIGNMENT.

ORIGINAL RELEASE 9/29/94  
-----

# **GSI / Top Dry**

## **Series 2000 Batch Errors and troubleshooting**

- \* **Dipswitch Settings**
- \* **Error Messages and solutions**
- \* **Operation TIPS**

### Configuration Dip Switches (Normally Done At Gsi)

These switches are used to configure the heater control for various types of heaters.

Multiple heaters connected together through the serial link.

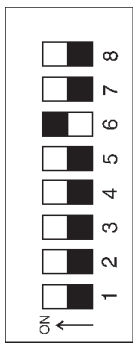

Top Dry stand alone with **no** remote display at the bottom-dip switch 6 on/all others off.

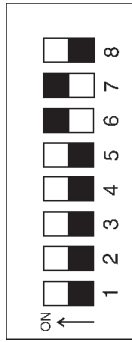

Top Dry master with a remote display at the bottom-dip switch 6 & 7 on/all others off.

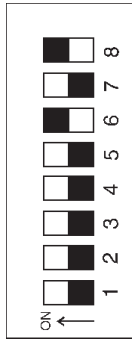

Top Dry master with a remote display at the bottom and one slave fan heater-dip switch 6 & 8 on/all others off.

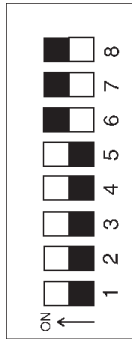

Top Dry master with a remote display at the bottom and 2 slave fan heater-dip switch 6, 7 & 8 on/all others off.

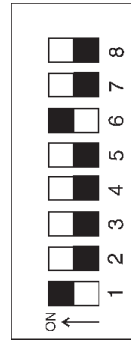

Top Dry remote display at the bottom-dip switch 1 & 6 on/all others off.

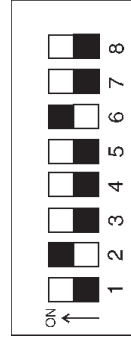

Top Dry 2nd fan heater-dip switch 2 & 6 on/all others off.

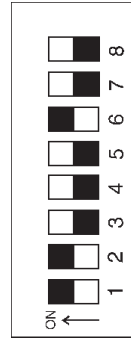

Top Dry 3rd fan heater-dip switch 1, 2 & 6 on/all others off.

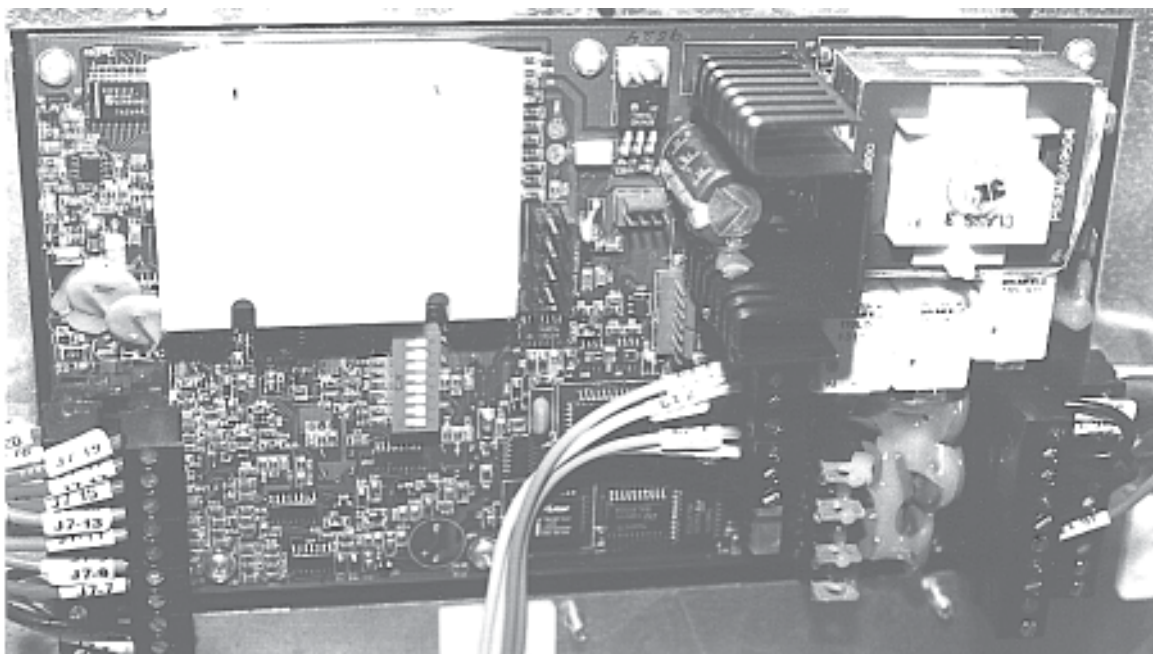

The backside of the control board, showing the dip switch placement.

**Limit Switches**

The following limit switch errors light up individually on the heaters LCD screen:

PLENUM, HOUSING, VAPOR, TEMPHILIMIT

**Multiple Heater Error Conditions**

Two or more heaters may be connected together through

the serial link. If the master cannot communicate with a slave controller, the master will display "SLA" on the main display and the "RX" "TX" symbols will be flashing. *If a limit switch error or one of the error numbers 1 through 8 occurs, that error is displayed on the slave where the error originates. The master displays "SLA ERROR".*

**MISC ERROR NUMBERS**

<b>1</b>	<b>2</b>	<b>3</b>	<b>4</b>	<b>5</b>	<b>6</b>
Plenum temperature probe 1 open	Plenum temperature probe 1 short	Grain temperature probe 2 open	Grain temperature probe 2 short	Airflow open	Airflow short
<b>7</b>	<b>8</b>	<b>9</b>	<b>10</b>	<b>11</b>	<b>12</b>
Illegal flame sense Error 7 is most likely caused by stuck open solenoid. Error 7 will not shut down fan until loss of flame is detected by control.	Flame probe short error	Slave #1 inconsistent with master with either the drying grain flag or the LP main solenoid-most likely the slave got reset powering up with the solenoids off	Slave #2 inconsistent same as error 9 for slave #1	Slave #3 inconsistent same as error 9 for slave #1	Wrong voltage. Dip switch #5 is the voltage selector switch. If dip switch #5 in "ON" that selects 240 VAC. If the unit has only 120 VAC applied, error 12 will show up. If dip switch #5 is "OFF" that selects 120 VAC. If the unit has 240 VAC applied error 12 will show up.  This is important because if the fan heater is set up at GSI for 120 VAC and the customer connects to 240 VAC the heater control will work, but if allowed to operate the solenoids will have 240 VAC applied to them which will damage solenoids.
(Errors 9 through 11 are displayed only if multiple heaters are tied together through serial link).					
Note: <i>Temperature sensor connection</i> -the temperature sensor (bolt) must always be connected to the master. In the case of the Top Dry, both temperature sensors must be connected to the master (unit at the top). Top Dry grain temperature input is connected to J7 pins 14 and 18.					

## Error Details

**Error #1 Plenum Temperature Probe Open.** The two wires for checking this error are on terminals 24 and 25 they are labeled J7-12 and J7-13. The wires must be removed from the terminals to receive a correct reading. This must be checked with a Ohm Meter. If the probe is open you will not receive any reading on your meter because there is no continuity between the wires. It is like you cut the wire in half. If there is resistance there is a certain resistance reading for current temperature of the probe. See Chart at the back of this section to verify that the sensor is correct. If the sensor is correct you probably did not have a good connection from one of your wires to the terminal strip.

**Error #2 Plenum Temperature Probe Short.** This error is indicating that the Plenum Temperature probe is shorted. This will also need to be check with a Ohm meter and if it is shorted will read no resistance as if you were checking both ends of one wire. Remember to disconnect the wires before checking.

**Error #3 Grain Temperature Probe Open.** This error is indicating the Grain Temperature Probe located in the drying chamber on a leleveling band is shorted.. The terminals for checking the Grain Temperature Probe are 22 and 23 and are labeled J7-14 and J7-18. The process for checking this error are the same as in error #1. Remember to disconnect the wires from these terminals before checking them.

**Error #4 Grain Temperature Probe Short.** This error is indicating that the Grain Temperature Probe is shorted. This is the same Probe as in error #3 and is checked like Error #2.

**Error #5 Airflow Open.** This error is indicating the airflow proving switch is in its open state and should be closed verifying there is no airflow so the fan heater will start. This must be checked with a Ohm meter and can be done directly on the airswitch terminals labeled N.O. And Common. This can also be checked on the terminal strip between terminals 12 and 14. They are labeled J7-09 and J7-10. The Airswitch can usually be adjusted and correct this error.

**Error #6 Airflow Short.** This error is indicating that the airswitch is stuck in both a normally open and normally closed state and needs to be adjusted, cleaned, or replaced.

**Error #7 Illegal Flame Sense.** This error is indicating that there was a flame sensed at a time it should not have. This is usually caused by a solenoid valve not closing properly. You can detect a solenoid not closing properly by watching the pressure gauge on the gas train. After the unit cycles off the pressure gauge will not drop immediately, it will gradually drop to zero or you can witch the flame and see if it is shutting off immediately or gradually burning out.

**Error #8 Flame Probe Short.** When this Error is given it can be either the flame probe is touching a metal surface or The flame probe wire has shorted to ground somewhere. To fix adjust the probe or replace the wire to the to of it.

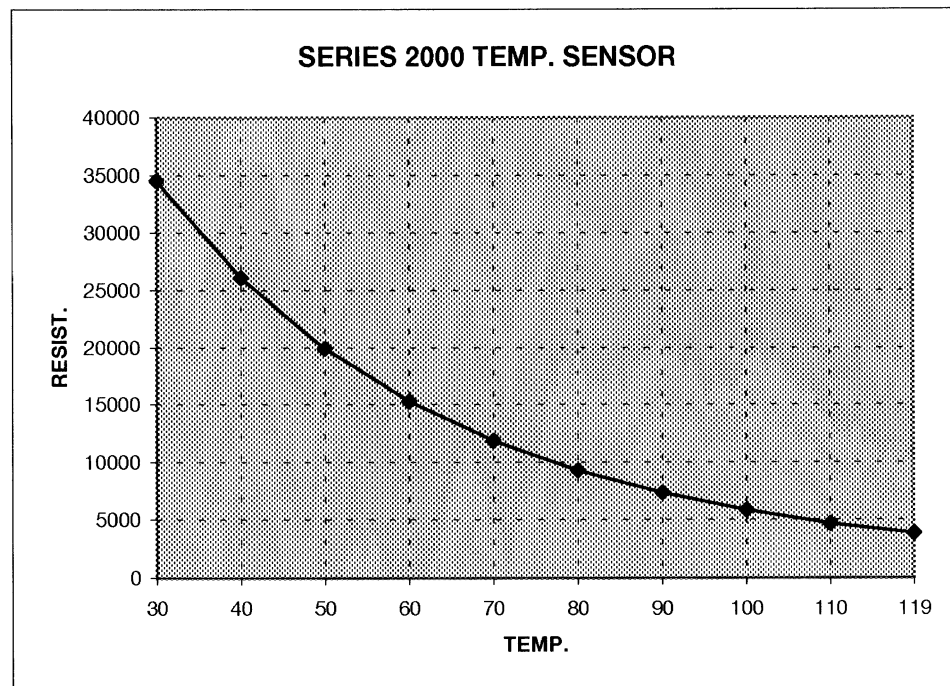
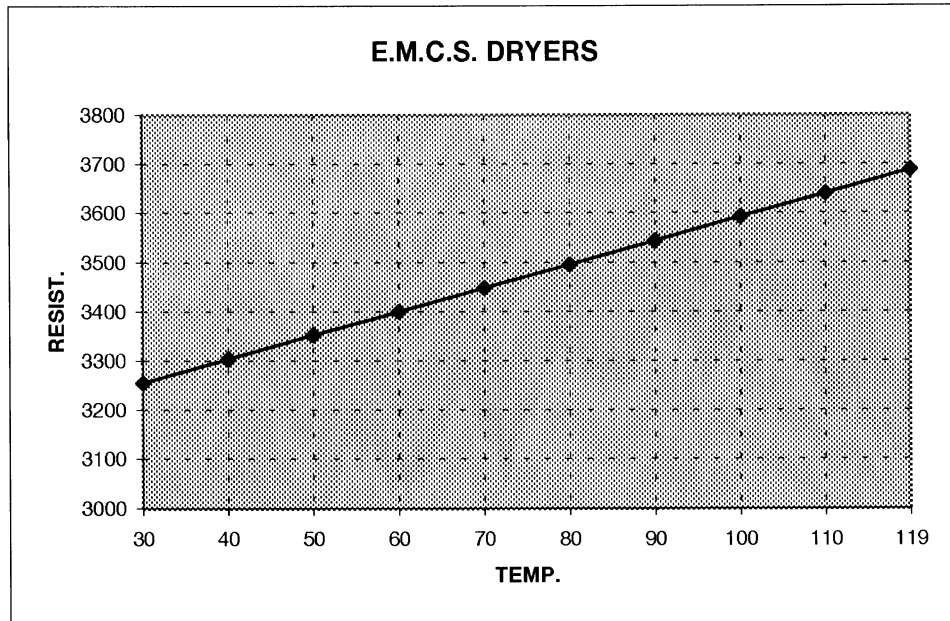

We use two (2) different types of sensors (NTC thermistor on the Series 2000, and an encapsulated sensor on the E.M.C.S) in our dryers. The resistance of the sensors varies according to the outside temperature. For example, on the E.M.C.S for every one (1) degree rise in temperature the resistance increases 4.8 ohms. However, on the Series 2000 dryer, the sensor reacts just the opposite, the resistance rises with colder temperatures. The charts displayed above will help when troubleshooting any sensor problems.



**SERIES 2000 BATCH TOPDRY TIPS**

**Operation Tips for Top Dry Batch**

**Special Wire Terminals**

**J7-10 or J7-13 on stand alone unit - 12 volt Ground for use with a tester.**  
**Any unused third terminal on any network connector is also a 12 volt ground.**

1. When ever you see **000 on the Screen** there is an Error some where on the screen.
2. To **Force a new time setting** while the Dryer is running Push the “Inc” (Up Arrow) and the “Dec” (Down Arrow) keys at the same time
3. To change the **Second Fan Start delay** hold down the “Program Dry/Cool Timers” and “Program Temperature” keys and turn on the power switch. **Note this must be done on the Master Fan and cannot be done of the Slave Fan or at the Remote Display.**
4. Turning Dip Switch 3 ON **disables the Air Flow** monitoring function for testing. Remember to turn OFF before leaving the Dryer as loss of airflow will not shut down the dryer if the switch is left on.
5. You can select **two modes for when the Drying Process stops.**
  - A. Standard setting which will shut down if either Grain Temperature **OR** Dry Time is met.
  - B. Optional setting in which both Grain Temperature **AND** Dry Time must be met.

To change this setting use the following steps.

1. While holding the Program Key in turn Power switch on.  
The Screen should read “0”
  2. Release the Program button and press the “Inc” (Up Arrow) key 3 times.  
The screen should read “3”.
  3. Press the Program Button until you see “NoL” (Standard setting)  
Press the “Inc” (Up Arrow) or “Dec” (Down Arrow) keys to change to “L”  
  
“NoL” - Will stop drying when meeting either the Time **OR** Temperature Settings.  
“L” - Will stop drying only if both Time **AND** Temperature Settings are met.
6. **To Clear the NOVRAM**  
Hold down the Program key (lower left key) and power the unit up. When the “0” comes up Enter a “7” with the Increment key (Up Arrow) and then push the Program Key again. When the “---“ comes up you have 2 Seconds to depress the “Inc” (Up Arrow) and “Dec” (Down Arrow) keys at the same time.  
(Do not do this unless you are told to or are at a last resort to fix inconsistent behavior of the board)
  7. When an Error shuts down the Dryer you can determine **how long ago the shutdown occurred** by pushing the “Dec” (Down Arrow) Key. It will read in hours with a maximum of 218 (9.1 days).
  8. **Drying Time has a minimum setting of 10 minutes** no matter what time is set.



## 2003 Top Dry Service School

---

### 11. **DIP Switch Settings** (Turn on Switches named and leave all others off)

#### **Top Dry Master**

Stand Alone - No Remote Display	6 ON
With Remote Display	6 & 7 ON

#### **Top Dry Master with Slave**

With or Without Remote Display	6 & 8 ON	Slave 2 and 6 ON
--------------------------------	----------	------------------

#### **Top Dry Master with 2 Slaves**

With or Without Remote Display	6,7 & 8 ON	First Slave 2 & 6 ON	Second Slave 1,2 &6 ON
--------------------------------	------------	----------------------	------------------------

<b>Top Dry Remote Display</b>	1 & 6 ON
-------------------------------	----------

### 12. **Temperature Sensor Testing**

A. You can find charts with the Resistance readings at various Temperatures in the following manuals  
Located in **Resource 2002 CD** in the “**Resources – Manuals**” Folder  
PNEG-630 Portable Dryer – Trouble Shooting Feb 1999.pdf **Page 54** (Portable Dryers | Trouble Shooting – Operating Tips)  
PNEG-377 Fan & Heater – Service Manual Feb 2000.pdf **Page 50** (Fans and Heaters | Trouble Shooting Guide)  
The Batch Top Dry’s use the Thermister type sensors, the bolt style for the Plenum and the Grain Temperature.

You have to disconnect the wires before testing. Check the charts listed above for readings at other temperatures.

10-15-02

1.

# **GSI / Top Dry**

## **Series 2000 Autoflow Errors and troubleshooting**

- \* **Error Messages and solutions**
- \* **Operation tips**

### **Error Messages**

When the dryer shuts down the user can quickly determine what caused the shutdown by viewing the display on the dryer control panel. The Electronic Monitoring Control System displays the error message and sounds a warning signal to alert the user. The displayed error conditions and their electrical cause are as follows:

#### **Burner 1 Loss Flame**

The flame sensor in burner number one has failed to detect flame. Either the burner failed to light or the flame sensor needs to be adjusted. The flame sensor is the sensor attached to the burner, and has a single lead. If the burner is lighting but the unit is still shutting down due to loss of flame the flame sensor needs to be adjusted. The flame sensor can be adjusted by bending it so it is immersed in flame. If the burner is not lighting make sure that the dryer is getting fuel, all solenoids are opening, and the ignitor is sparking.

#### **Burner 2 Loss Flame**

The flame sensor in burner number two has failed to detect flame. Either the burner failed to light or the flame sensor needs to be adjusted. The flame sensor is the sensor attached to the burner, and has a single lead. If the burner is lighting but the unit is still shutting down due to loss of flame the flame sensor needs to be adjusted. The flame sensor can be adjusted by bending it so it is immersed in flame. If the burner is not lighting make sure that the dryer is getting fuel, all solenoids are opening, and the ignitor is sparking.

#### **Fan 1 Vapor High Limit**

The LP gas vapor temperature sensor located on the gas pipe train downstream from the vaporizer coil on fan and heater number one has opened indicating that the vaporizer coil is running too hot and must be adjusted. This sensor is set at 200 degrees Fahrenheit

and automatically resets itself when cool. The vaporizer is adjusted by loosening the bolt and moving the vaporizer coil away from the flame.

#### **Fan 2 Vapor High Limit**

The LP gas vapor temperature sensor located on the gas pipe train downstream from the vaporizer coil on fan and heater number two has opened indicating that the vaporizer coil is running too hot and must be adjusted. This sensor is set at 200 degrees Fahrenheit and automatically resets itself when cool. The vaporizer is adjusted by loosening the bolt and moving the vaporizer coil away from the flame.

#### **Fan 1 Housing High Limit**

The temperature high limit located on the housing on fan and heater number one opened, indicating that the housing towards the bin has overheated. This high limit sensor is set at 200 degrees Fahrenheit and must be manually reset.

#### **Fan 2 Housing High Limit**

The temperature high limit located on the housing on fan and heater number two opened, indicating that the housing towards the bin has overheated. This high limit sensor is set at 200 degrees Fahrenheit and must be manually reset.

#### **Plenum High Limit**

An over temperature condition has occurred inside the dryer plenum. The plenum high limit is set automatically on the Hi-lo thermostat when the cycle set-point is adjusted and resets automatically when cooled. The lo-fire gas pressure needs to be lowered, or the cycle setpoint on the Hi-lo thermostat needs to be increased if the error is displayed frequently.

**Fan 1 Motor Overload**

The thermal overload in the control box on fan number one has tripped, indicating an overcurrent condition. The overload must be reset manually.

**Fan 2 Motor Overload**

The thermal overload in the control box on fan number two has tripped, indicating an overcurrent condition. The overload must be reset manually.

**Fan 1 Loss Of Airflow**

The contacts on the airswitch, located in the bin sidewall and attached to fan and heater number one, have opened due to the fan not turning, or the airswitch may need to be adjusted.

**Drying Chamber Overflow**

The grain level in the drying chamber has reached the drying chamber overflow rotary switch. Grain will have to be dumped from the drying chamber to the storage chamber before the unit can be restarted. This error indicates that either the drying chamber high level rotary switch is faulty or the time on the Load delay or Aux. 1 delay needs to be lowered.

**Bin Grain High Limit Full**

The grain level in the storage chamber has reached the storage chamber high level rotary switch located 3 feet below the fan and heater(s). Grain will have to be removed from the storage chamber before the unit can be restarted.

**Bin High Limit Switch Bad**

The storage chamber high level switch has failed. Both the normally open and the normally closed sides of the switch are in the same state.

**Out Of Grain**

The out of grain timer has ran for longer than it was set. Either you are out of grain or the fill system is filling to slow.

### **Wet Supply Empty Press <Enter> To Dry Remaining Grain**

This message is displayed when the start button is pushed and grain has fallen away from the wet supply rotary switch and there is still grain against the drying chamber low level rotary switch. If the enter button is pushed the dryer will restart, but the fill system(s) will not restart.

### **Cannot Start Dryer Wet Supply Empty**

This message is displayed when the start button is pushed and grain has fallen away from the wet supply rotary switch and there is no grain against the drying chamber low level rotary switch. Grain will have to be put into the wet supply tank or the drying chamber to start the dryer.

### **Low Level Switch Exposed**

This message is displayed when grain falls away from the drying chamber low level rotary switch after the Wet Bin Switch Delay has reached zero. If the error is being caused due to the settling of grain after the fans start the time on the Wet Bin Switch Delay can be lengthened.

### **Fill 1 Motor Overload**

The thermal overload in the fill system control box for fill system number one has tripped, indicating an overcurrent condition. The overload must be reset manually.

### **Fill 2 Motor Overload**

The thermal overload in the fill system control box for fill system number two has tripped, indicating an overcurrent condition. The overload must be reset manually.

### **Aeration Overload**

The thermal overload in the fill system control box for the aeration fan has tripped, indicating an overcurrent condition. The overload must be reset manually.

### **Grain High Limit**

The grain temperature in the drying chamber is too high. The grain temperature reached a point where it was five degrees less than the plenum cycle setpoint.

## Network Autoflow Tips

Present Version Numbers: Display → 2.15 Heater → 1.09 IO → 1.07

Note: Display version 2.14 and 2.15 will not work with Heater version 1.10 you must use version 1.09.

### Important Software and Troubleshooting tips

**Special Wire Terminals - The third unused terminal on any network connector is a 12 V ground for use with a tester.**

1. When ever you install a new display board. After you flash the software in and restart you may see an ERROR Message with some garbage characters or a negative number for temperature such as -2785 degrees. Do a Hard Boot by holding the Reset key and turning the power on to correct this stuck register value.
2. **Always do a Hard Boot after installing a new Display board.**
3. **If you have a blank or all black screen see the Contrast Adjustment in Tip #1**
4. **Also when flashing new software to the IO Board turn off the load auger breaker(s).** Due to a design characteristic the load auger(s) will run whenever the IO board is being flashed.
5. If the Fan motors run, but the augers and aeration fan do not, make sure the 110 volt breaker on the IO board is turned on.
6. The **newest Display boards (5/1/02) can now be used on either a Topdry or Portable Dryer.** In the past a Dryer Display board had to have wires soldered in place for the Meter Roll Speed Pot and they can also be used on either a Top Dry or Portable Dryer. **The past Top Dry Display board without these wires could be used on a Top Dry only.** The newest boards now have a six pin connector that the Dryer Meter Roll Speed Pot is connected to.
7. **If you get a plenum High Limit Error on startup with a new system or after installing new software on a Two Fan Top Dry** check to see if a jumper from J7-3 to J7-15 fixes it.
8. **Grain Temperature Sensors** are 10 ½” from the top of the floor rib. Older Top Dries were 14” from the flat of the floor.

### Version Specific changes

**Version 2.15** See separate Sheet at page 3 for substantial changes in operation.

**Version 2.14** 1. **Extended Setup is now accessed by holding down the Modify key while powering up**  
2. Low limits were set. 150 degrees for Grain High limit and 200 degrees for Plenum High limit.

**Version 2.11** 1. **When grain reaches the Storage Chamber Rotary Switch** a "Cool Down Mode" will be entered.

The fan will run and cool the grain for **10 minutes** before shutting down due to a Storage Chamber Full error.

When grain leaves the **Wet Supply Rotary Switch**. The fan will cool for **10 minutes** before giving out of grain error .

When the **Dry & Hold switch** is placed in the "On" position the fan will Cool for **20 minutes** before stopping.

**Version 2.06** Stopped the ability to change the grain setpoint from heaters.

**Version 2.04** **Made all air switches active once again. New venturi Air Switches must be present** on each fan where more then one fan is in use. Single Fan systems can continue to use the existing Plenum Air Switch.

**Version 2.03** The user can no longer go into **Extended Set Up** while the dryer is running.

**Version 1.02** Release Date Jan of 98 the **Bin High Limit rotary switch is now monitored in both states** to insure that a switch

failure has not taken place. If both switches are in the same state a switch failure is reported.

## 2003 Top Dry Service School

---

- 8) **Bin High Pressure Limit.** The application of 12v to terminal number **J2-20** will shutdown the dryer and give an indication that the bin is full due to the high level of static pressure within. "**BIN AIR PRESSURE LIM**" will be displayed on screen's top line until the user corrects the problem. (Originally looked for lack of 12v, reversed in 2.00)
- 9) There is a **User Batch Count and User Timer or Hour Meter** independent from the Total batch and Total time allowing intermediate monitoring of batches and time. You **Reset the User Batch Count** from the "Setup" Key. You **Reset the User Hour Meter** by holding in the "**Hours**" key while turning on the "**Control Power**".
- 10) **Master & Slave Fan & Heater Dipswitch Settings**  
Pg 42 Fan 1 (Master) #1 OFF / All others ON  
Pg 50 Fan 2 (Slave 1) #2 OFF / All others ON  
Pg 51 Fan 3 (Slave 2) #1 & #2 OFF / All others ON  
Information above from PNEG-900 included in the CD in the Top Drys/Top Dry Fans & Htrs Operation Charts folder as  
99 Series 2000 AutoFlow - Installation Pneg-900 July 1999.pdf
- 11) **Temperature Sensor Testing**  
1. You can find charts with the Resistance readings at various Temperatures in the following manuals  
Located in **Resource 2002 CD** in the "**Resources – Manuals**" Folder  
PNEG-630 Portable Dryer – Trouble Shooting Feb 1999.pdf **Page 54** (Portable Dryers | Trouble Shooting – Operating Tips)  
PNEG-377 Fan & Heater – Service Manual Feb 2000.pdf **Page 50** (Fans and Heaters | Trouble Shooting Guide)  
The Network Top Dry's use the Thermister type sensors, the bolt style for the Plenum and for the Grain Temperature.  
You have to disconnect the wires before testing. Check the charts listed above for readings at other temperatures.
- 11) **SETUP** – What can be changed and the order they show up on the screen. (See 2.15 for changes)  
**As of software version 2.14 extended setup is reached by holding down the Modify key while powering up.**  
A) **EXTENDED SETUP:** (Control Circuit must be off to access prior to version 2.14)  
1) Set the Clock.  
2) Enable/Disable Air Switches. Disable for adjustment purposes only.  
3) Enable/Disable Low Level Test. Enable to ignore low level  
4) Enable/Disable Wet Tank Test. Enable to run with no grain in Wet Tank.  
5) Choose to start with fans on high or low. Low for US & Canada, High for Europe. **(Did not work until 2.15)**  
6) Aeration Fan Bypass Selection. When bypassed Fan does not shut down when Top Dry shuts down.  
7) Setup fill systems. One or Two Auger System.  
8) Select type of dryer. AF1 = 1 fan or AF2 = 2 fan (Auto Flow) AB1 or AB2 (Auto Batch)  
9) Select Temperature Scale - Fahrenheit or Centigrade.  
10) Select burner ON/OFF or HI/LO.  
11) Select diesel burner.  
12) **As of Version 2.15** The Plenum High Limit is adjustable from 10 to 50 deg. above setpoint. Default = 20  
13) **As of Version 2.15** The Grain High Limit is adjustable from 10 to 50 deg. above setpoint. Default = 30

### New Features

1. **Out of Grain Timer** – Located under the “**Setup**” key. This Timer monitors how long the Load system runs including delay time and shuts down the Top Dry, goes through the “Cleanout” of the Augers procedure and then gives an “**Out of Grain**” Warning. Default setting is 20 minutes. The “Load” switch “ON” position works exactly like “Auto” but ignores the Timer.
2. **The High Limits on the Grain and Plenum Temperatures** are now settable. User selects how many degrees above the set points that a “**Grain or Plenum High Limit**” Warning will be displayed. Defaults are 30 degrees for the Grain and 20 degrees above the set points. Both are settable from 10 to 50 degrees. These settings are accessed by turning on the “**Control Power**” while holding down the “**Modify**” key, in the **Extended Setup**, so they can be reset to allow operation after the User has determined there is no fire hazard. This in effect gives the system an “**Emergency Cooling**” capability.
3. The **Wet Bin Rotary Switch** now has a **Delay Setting** accessed from the “**Delay**” Key. This will delay the shutting down of the Top Dry and display of the “**Wet Bin SW Exposed**” Warning after grain no longer covers the switch. This is to allow for variations in where the switch needs to be located for differences in the moisture of the incoming grain. The New Out of Grain Timer will make this Delay less likely to be used however.
4. Implemented the “**Start Fans with High**” feature that was previously listed in the “**Extended Setup**” list but was not functional.

### Changed Names

1. “**Fan Delay**” is now “**Motor Delay**” to better describe the fact that the delay not only delays the time between when the Fans start but also the time between when any Fan or Loading Motors start.
2. When the **Drying Chamber Low Level Rotary Switch** is exposed it will now say “**Lo Level SW Exposed**” not “**Dry Chamber Empty**”.
3. When the **Wet Bin Rotary Switch** is exposed it will now say “**Wet Bin SW Exposed**” not “**Dryer out of Grain**”
4. The Delay formerly called the “**Out of Grain**” Delay which delayed the shutting down of the system if grain came off the Drying Chamber Low level Switch is now called the “**Lo level SW**” Delay.
5. Under the **Extended Setup** accessed by holding down the “**Modify**” key while turning on the “**Control Power**” those items that were described as “**Tests**” are now named as just the Switch itself. Enabling the switch means it is monitored by the System and Disabled means it is not monitored.
  - A. AIRSWITCH - Enabled means you will get a shutdown when a fan loses airflow. Disabled will satisfy the dryer's airflow requirements for the burner regardless of the actual air switch state.
  - B. LOW LEVEL SWITCH - Enabled means the drying chamber low level switch will act as normal, i.e, will indicate the real state of the rotary switch and will shut down after the user set delay when uncovered. When disabled the dryer will think the low level switch is always covered.
  - C. WET TANK SWITCH - Enabled means this switch will act as normal, shutting down the system when uncovered. Disabled means the dryer will think this switch is always covered with grain.
  - D. START FANS WITH HIGH - Enabled means the dryer will start fans according to state of drying chamber hi level switch. Disabled means dryer will start according to drying chamber low level switch.
  - E. AERATION FAN BYPASS - Enabled means the BYPASS is on and the Fan will run whenever the “Control Power” switch is turned on.

### Simplifications & Improvements

1. In the Auto Flow Mode the “**Refill Timer**” and “**Time until load off**” Batch only screens will not show up.
2. Instead of using a different name for the Delay which affects the Drying Chamber Low Level Rotary Switch depending on whether the system is set for a 1 fill or 2 fill system it will always be called “**Hi Level SW**” Delay.
3. Instead of Delay, that affects when the Fill 1 load system stops in a 2 fill system, changing names and coming up on screen when a 1 fill system has been set it will only show up when a 2 fill system has been set and will be called “**Fill System #1**” Delay.
4. The amount of time the Delays and other settings stay on the screen before moving to the next has been doubled.
5. The Cool Down feature which runs after an “**Out of Grain**”, “**Storage Bin Full**” or “**Wet Bin SW Exposed**” shutdown or after the system stops because the “**Stop and Hold**” switch has been turned on, now Cools for whatever time the Cool Timer has been set for.



# GSI / Top Dry

## Software Diagnostics

- \* **Series 2000 Batch Fan & Heater**
- \* **Series 2000 Autoflow Display**
- \* **Series 2000 Autoflow Fan & Heater**



## Series 2000 Batch Fan / Heater

### Initializing the Novram

- Turn the Control Power “off”.
  - Hold down the Program Temperature switch.
  - Turn the Control Power switch “on” with the Program Temperature switch held down.
  - Press the Increase switch until 7 is on the display.
- Press the Program Temperature switch again.
  - You have two seconds to depress the Increase or Decrease switches at the same time.
  - The NOVRAM has been initialized.

NOTE: The computer has now been cleared of all memory, including the type of dryer it is and all Set-up variables.

## Series 2000 Batch Fan / Heater

### Programming Set-up Variables

- Turn the Control Power “off“
  - Turn the Control Power switch “on“ with the Program Temperature switch held down.
  - Press the Increase switch until 3 is on the display.
  - Press the Program Temperature switch again.
  - **C** or **no C** will be displayed.
  - Use the Increase or Decrease switch to toggle between **C** or **no C**.
    - C** - Hi-Lo cycling heater
    - no C** - On/Off cycling heater
  - When the correct selection is on the screen press the Program Temperature switch again.
  - **H** or **no H** will be displayed.
  - Use the Increase or Decrease switch to toggle between **H** or **no H**.
    - H** - Humidity sensor present
    - no H** - No humidity sensor present
  - When the correct selection is on the screen press the Program Temperature switch again.
- **F** or **C** will be displayed.
  - Use the Increase or Decrease switch to toggle between **F** or **C**.
    - F** - Temperatures displayed in Fahrenheit.
    - C** - Temperatures displayed in Celsius.
  - When the correct selection is on the screen press the Program Temperature switch again.
  - **L** or **no L** will be displayed.
  - Use the Increase or Decrease switch to toggle between **L** or **no L**.
    - L** - The dryer will advance to the Cool cycle when the Dry timer has reached zero and the Grain temperature set point has been met.
    - noL** - The dryer will advance to the Cool cycle when either the Dry timer has reached zero or the Grain temperature set point has been met.
  - When the correct selection is on the screen press the Program Temperature switch again.

## Series 2000 Batch Fan / Heater

**CAUTION: DO NOT ATTEMPT BELOW PROCEDURE WITH GAS LINE CONNECTED.**

### Diagnostic Mode

- Turn the Control Power “off”.
- Hold down the Program Temperature switch.
- Turn the Control Power switch “on” with the Program Temperature switch held down.
- Press the Increase switch until 8 is on the display.
- Press the Program Temperature switch again.
- Press the Program Dry time switch to engage the Fan starter-**Fan** will be displayed.
- Press the Increase switch to make the ignitor spark-**IN** will be displayed.
- Press the Program Temperature switch to open the LP and Main Solenoid- **LP** will be displayed.
- Press the Start switch to open the Cycle solenoid -**CS** will be displayed.
- Turn the control power “off” to exit the Diagnostic mode.

## Series 2000 Autoflow Display

### Keypad Test

- Turn the Control Power “off”.
- Turn the Control Power switch “on” with the Help Switch pressed.
- The Keypad Switches can now be tested.

### Control Switch Tests

- Turn the Control Power “off” .
- Turn the Control Power switch “on” with the Plenum and Grain Switches pressed.
- The Control Switches can now be tested.

## Series 2000 Autoflow Fan / Heater

**CAUTION: DO NOT ATTEMPT BELOW PROCEDURE WITH GAS LINE CONNECTED.**

### **Diagnostic Mode**

- Turn the Control Power “off”.
  - Hold down the Program Temperature switch.
  - Turn the Control Power switch “on” with the Program Temperature switch held down.
  - Press the Program Dry time switch to engage the Fan Starter.
  - Press the Program Temperature switch to start the Ignitor.
- Press the Hours x 1000 switch to open the Solenoid.
  - Turn the control power “off” to exit the Diagnostic mode.

THE GSI GROUP, INC. ("GSI") WARRANTS ALL PRODUCTS MANUFACTURED BY GSI TO BE FREE OF DEFECTS IN MATERIAL AND WORKMANSHIP UNDER NORMAL USAGE AND CONDITIONS FOR A PERIOD OF TWELVE MONTHS AFTER RETAIL SALE TO THE ORIGINAL END USER OF SUCH PRODUCTS. GSI'S ONLY OBLIGATION IS, AND PURCHASER'S SOLE REMEDY SHALL BE FOR GSI, TO REPAIR OR REPLACE, AT GSI'S OPTION AND EXPENSE, PRODUCTS THAT, IN GSI'S SOLE JUDGMENT, CONTAIN A MATERIAL DEFECT DUE TO MATERIALS OR WORKMANSHIP. ALL DELIVERY AND SHIPMENT CHARGES TO AND FROM GSI'S FACTORY WILL BE PURCHASER'S RESPONSIBILITY. EXPENSES INCURRED BY OR ON BEHALF OF THE PURCHASER WITHOUT PRIOR WRITTEN AUTHORIZATION FROM AN AUTHORIZED EMPLOYEE OF GSI SHALL BE THE SOLE RESPONSIBILITY OF THE PURCHASER.

EXCEPT FOR THE ABOVE STATED EXPRESS LIMITED WARRANTIES, GSI MAKES NO WARRANTY OF ANY KIND, EXPRESSED OR IMPLIED, INCLUDING, WITHOUT LIMITATION, WARRANTIES OF MERCHANTABILITY OR FITNESS FOR A PARTICULAR PURPOSE OR USE IN CONNECTION WITH (i) PRODUCT MANUFACTURED OR SOLD BY GSI OR (ii) ANY ADVICE, INSTRUCTION, RECOMMENDATION OR SUGGESTION PROVIDED BY AN AGENT, REPRESENTATIVE OR EMPLOYEE OF GSI REGARDING OR RELATED TO THE CONFIGURATION, INSTALLATION, LAYOUT, SUITABILITY FOR A PARTICULAR PURPOSE, OR DESIGN OF SUCH PRODUCT OR PRODUCTS.

IN NO EVENT SHALL GSI BE LIABLE FOR ANY DIRECT, INDIRECT, INCIDENTAL OR CONSEQUENTIAL DAMAGES, INCLUDING, WITHOUT LIMITATION, LOSS OF ANTICIPATED PROFITS OR BENEFITS. PURCHASER'S SOLE AND EXCLUSIVE REMEDY SHALL BE LIMITED TO THAT STATED ABOVE, WHICH SHALL NOT EXCEED THE AMOUNT PAID FOR THE PRODUCT PURCHASED. THIS WARRANTY IS NOT TRANSFERABLE AND APPLIES ONLY TO THE ORIGINAL PURCHASER. GSI SHALL HAVE NO OBLIGATION OR RESPONSIBILITY FOR ANY REPRESENTATIVE OR WARRANTIES MADE BY OR ON BEHALF OF ANY DEALER, AGENT OR DISTRIBUTOR OF GSI.

GSI ASSUMES NO RESPONSIBILITY FOR FIELD MODIFICATIONS OR ERECTION DEFECTS WHICH CREATE STRUCTURAL OR STORAGE QUALITY PROBLEMS. MODIFICATIONS TO THE PRODUCT NOT SPECIFICALLY COVERED BY THE CONTENTS OF THIS MANUAL WILL NULLIFY ANY PRODUCT WARRANTY THAT MIGHT HAVE BEEN OTHERWISE AVAILABLE.

THE FOREGOING WARRANTY SHALL NOT COVER PRODUCTS OR PARTS WHICH HAVE BEEN DAMAGED BY NEGLIGENT USE, MISUSE, ALTERATION OR ACCIDENT. THIS WARRANTY COVERS ONLY PRODUCTS MANUFACTURED BY GSI. THIS WARRANTY IS EXCLUSIVE AND IN LIEU OF ALL OTHER WARRANTIES EXPRESS OR IMPLIED. GSI RESERVES THE RIGHT TO MAKE DESIGN OR SPECIFICATION CHANGES AT ANY TIME.

PRIOR TO INSTALLATION, PURCHASER HAS THE RESPONSIBILITY TO RESEARCH AND COMPLY WITH ALL FEDERAL, STATE AND LOCAL CODES WHICH MAY APPLY TO THE LOCATION AND INSTALLATION



a division of

---

THE GSI GROUP

