



New Auto Flow Top Dry Leveling Band Locations - Explanation

Grain drying is a complex task in these days due to tough climatic conditions and seed variability. More care is needed to deal with moisture, varied density, higher test weights and kernel makeup while drying the grain. The leveling band locations for the Auto Flow Top Dry systems are changed to meet these requirements and enhance drying efficiency.

For all the sizes of Auto Flow Top Dry systems, the new positions of the leveling bands will reduce the grain depths in each of the outer rings. The lowest leveling band in the outer set of bands was removed, allowing proper grain flow. The locations of the grain temperature sensors are lowered by 2" to keep the sensors at proper locations relative to the new grain depth. The new leveling band changes increases the airflow per bushel and improved drying capacity.

If operators experience a quality or capacity issues with the Auto Flow systems, it is advised to adjust the leveling bands to the new locations using the following diagrams.

NOTE: *The 18' Auto Flow Top Dry use was discontinued due to the inability to get the leveling band positions that would work consistently. The 18' Auto Flow leveling band positions are not shown for this reason.*



Positioning the Top Dry Leveling Bands

21' Leveling Band Locations

Position leveling bands as shown in the [Figure 1 and Figure 2](#).

Use two (2) 5/16" x 3/4" bin bolts to attach bands to posts. Also, use 5/16" x 3/4" bin bolts to join band sections. **Note that band sections connect to each other only at end most holes until completing the circle where an overlap may occur.**

Inner Leveling Bands

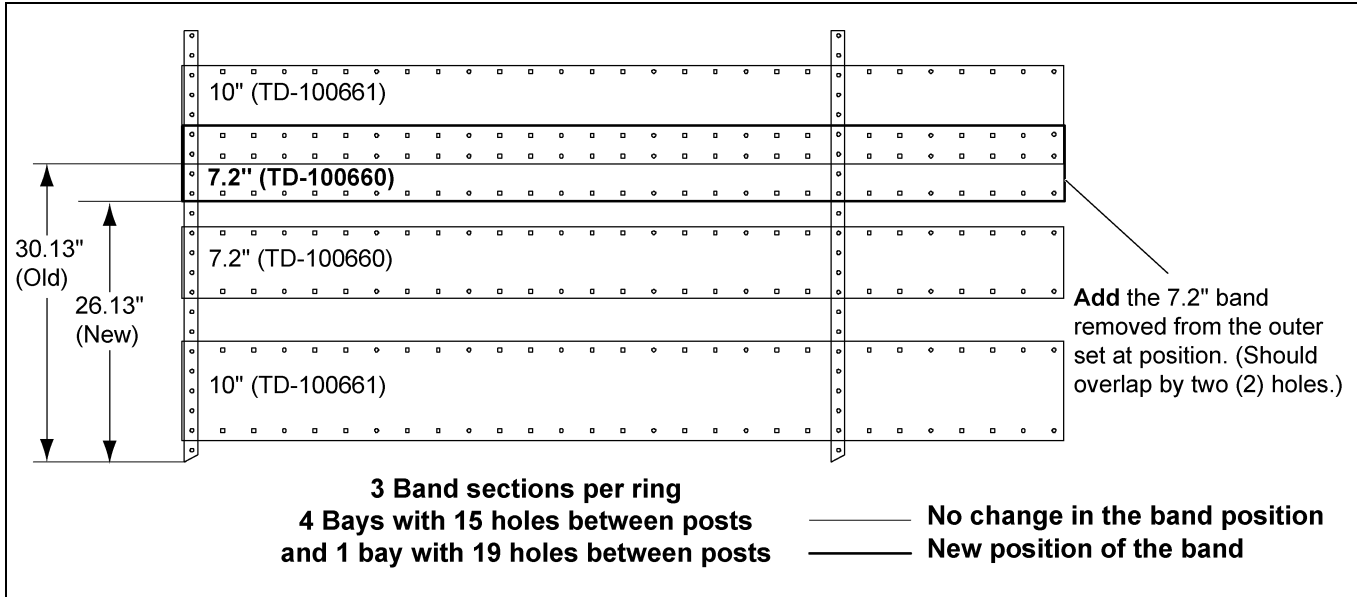

Figure 1

Outer Leveling Bands

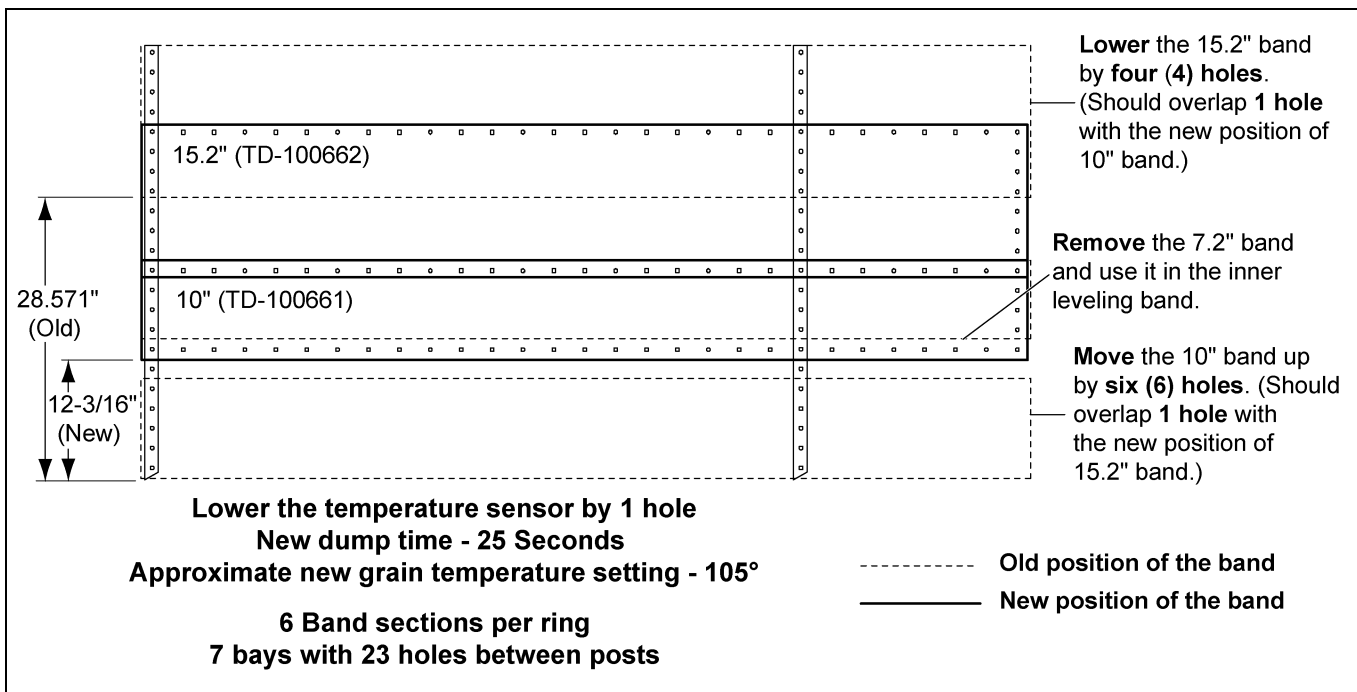

Figure 2

24' Leveling Band Locations

Position leveling bands as shown in the [Figure 3](#) and [Figure 4](#).

Use two (2) 5/16" x 3/4" bin bolts to attach bands to posts. Also use 5/16" x 3/4" bin bolts to join band sections. **Note that band sections connect to each other only at end most holes until completing the circle where an overlap may occur.**

Inner Leveling Bands

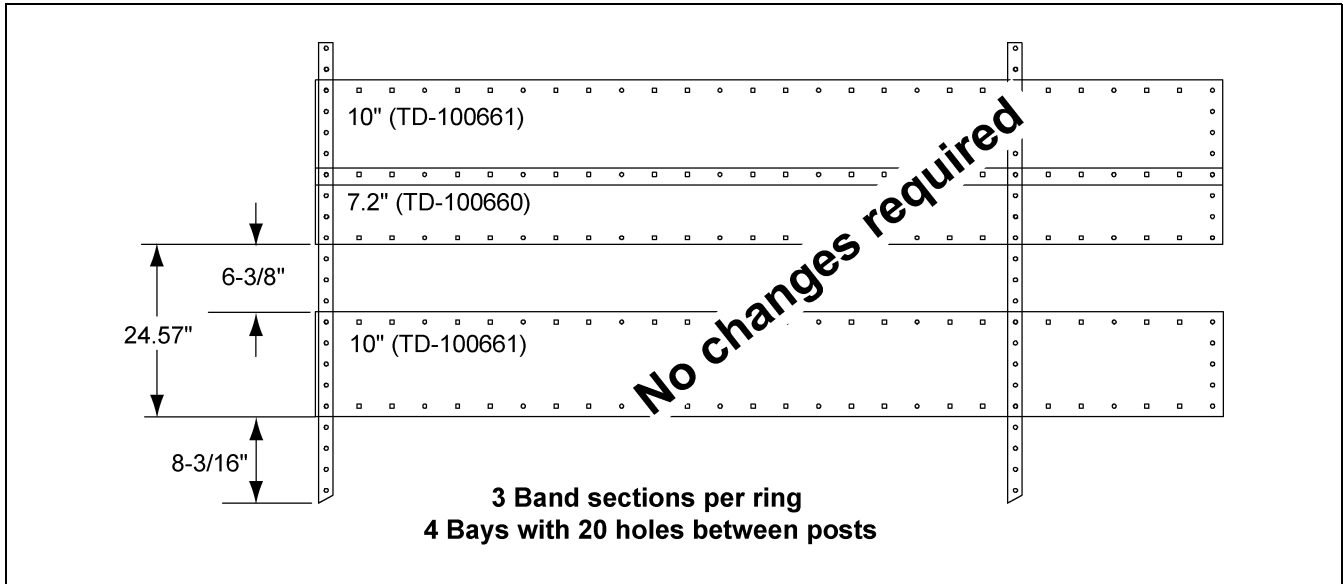

Figure 3

Outer Leveling Band

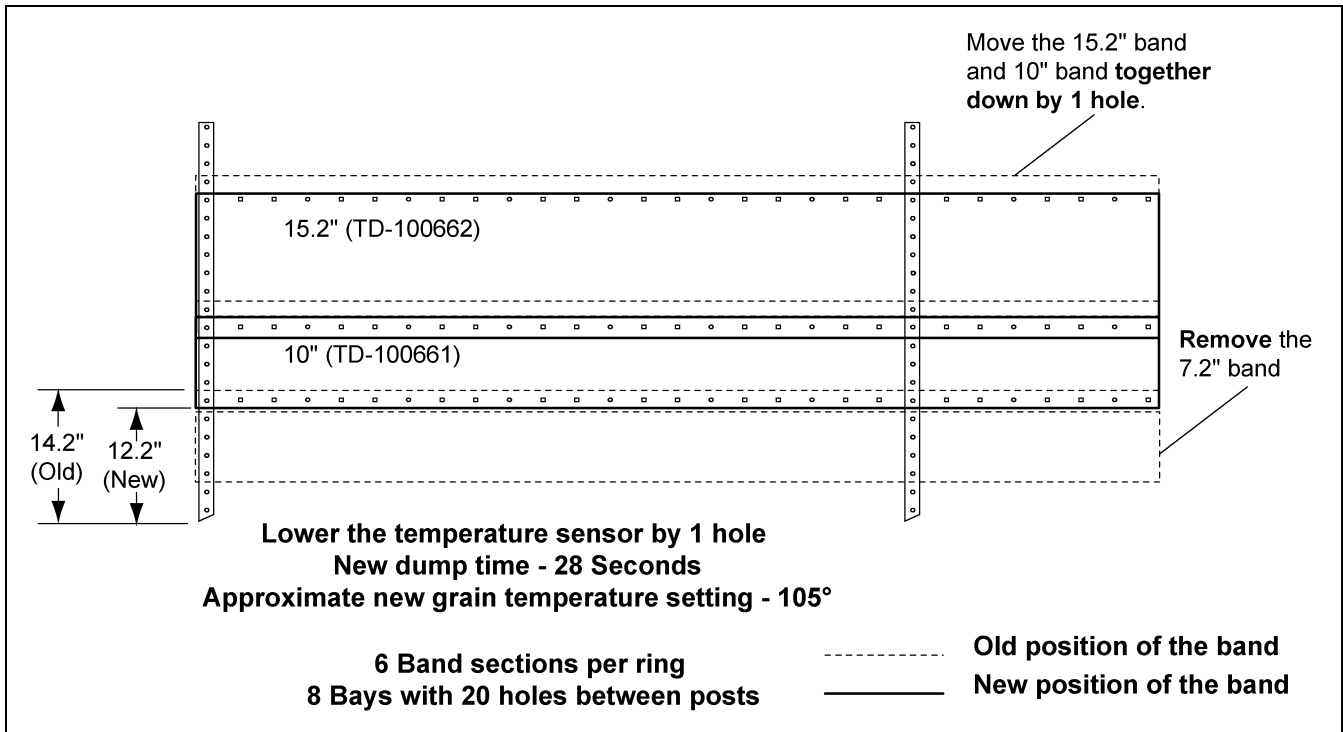

Figure 4

Positioning the Top Dry Leveling Bands

27' Leveling Band Locations

Position leveling bands as shown in the *Figures 5-7 on Pages 4-5*.

Use two (2) 5/16" x 3/4" bin bolts to attach bands to posts. Also use 5/16" x 3/4" bin bolts to join band sections. **Note that band sections connect to each other only at end most holes.** Due to the odd number of rafters leveling band posts spacing is not equal on the inner and outer leveling bands.

NOTE: The band sets are in a different order than the others.

Inner Leveling Bands

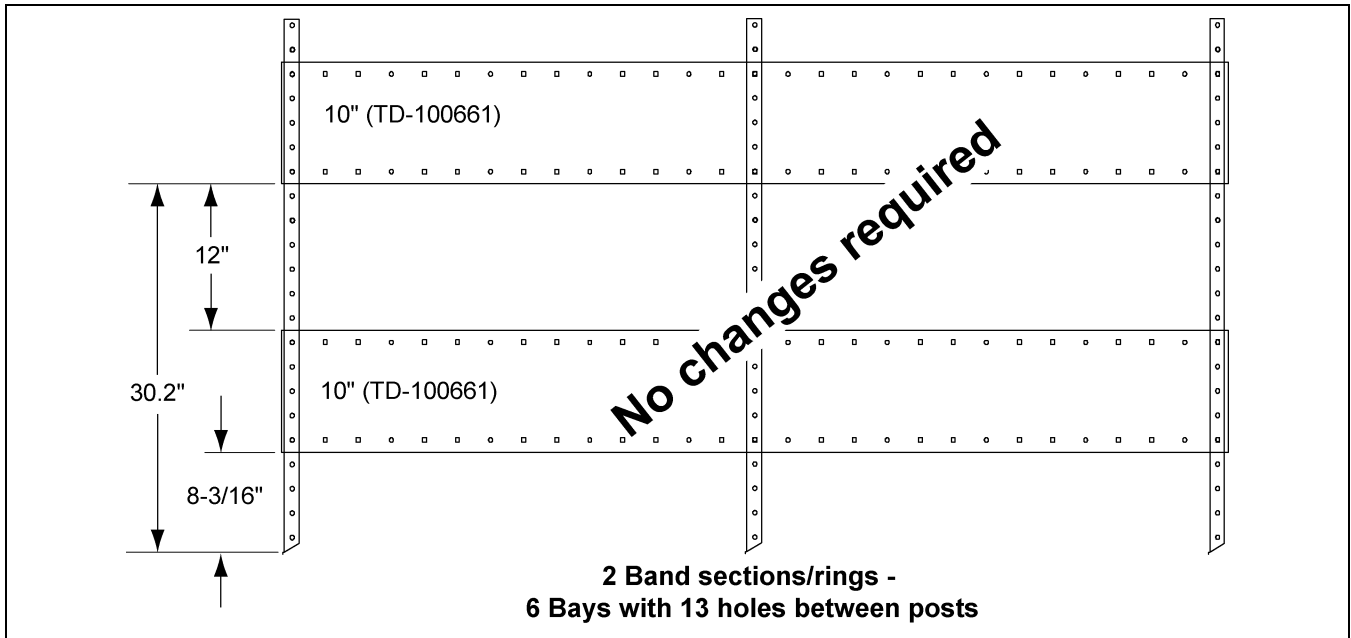

Figure 5

Middle Leveling Bands

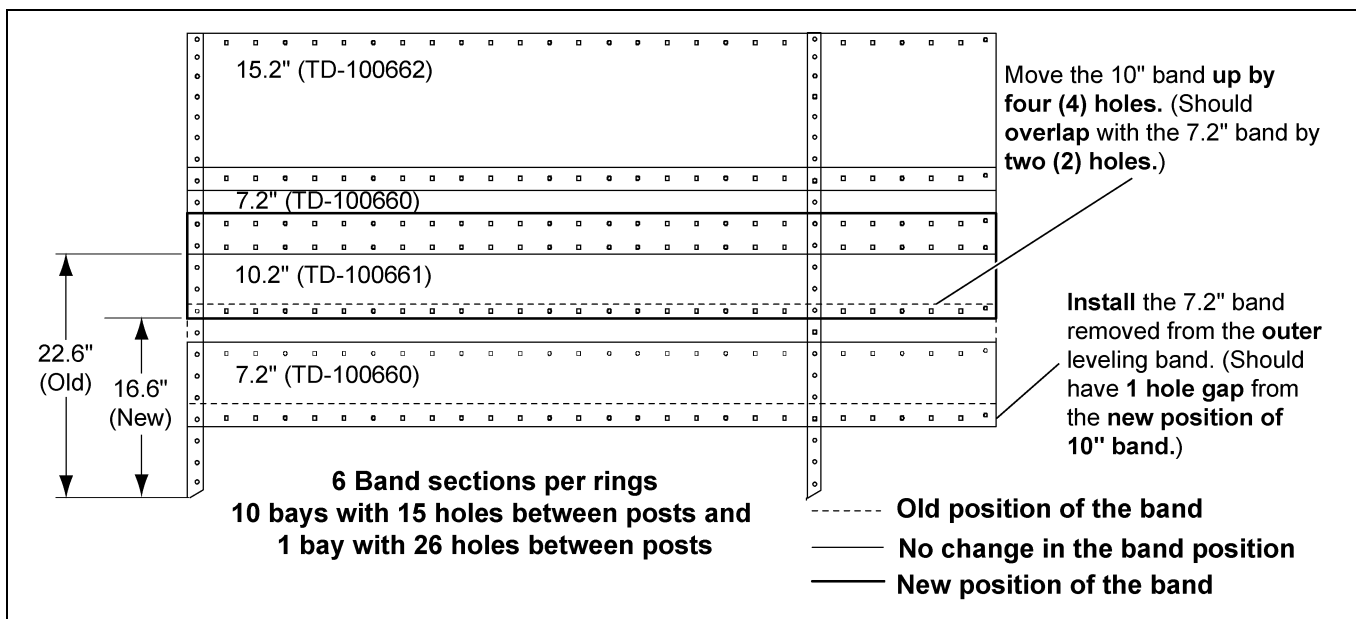

Figure 6

27' Leveling Band Locations (Continued)

Outer Leveling Bands

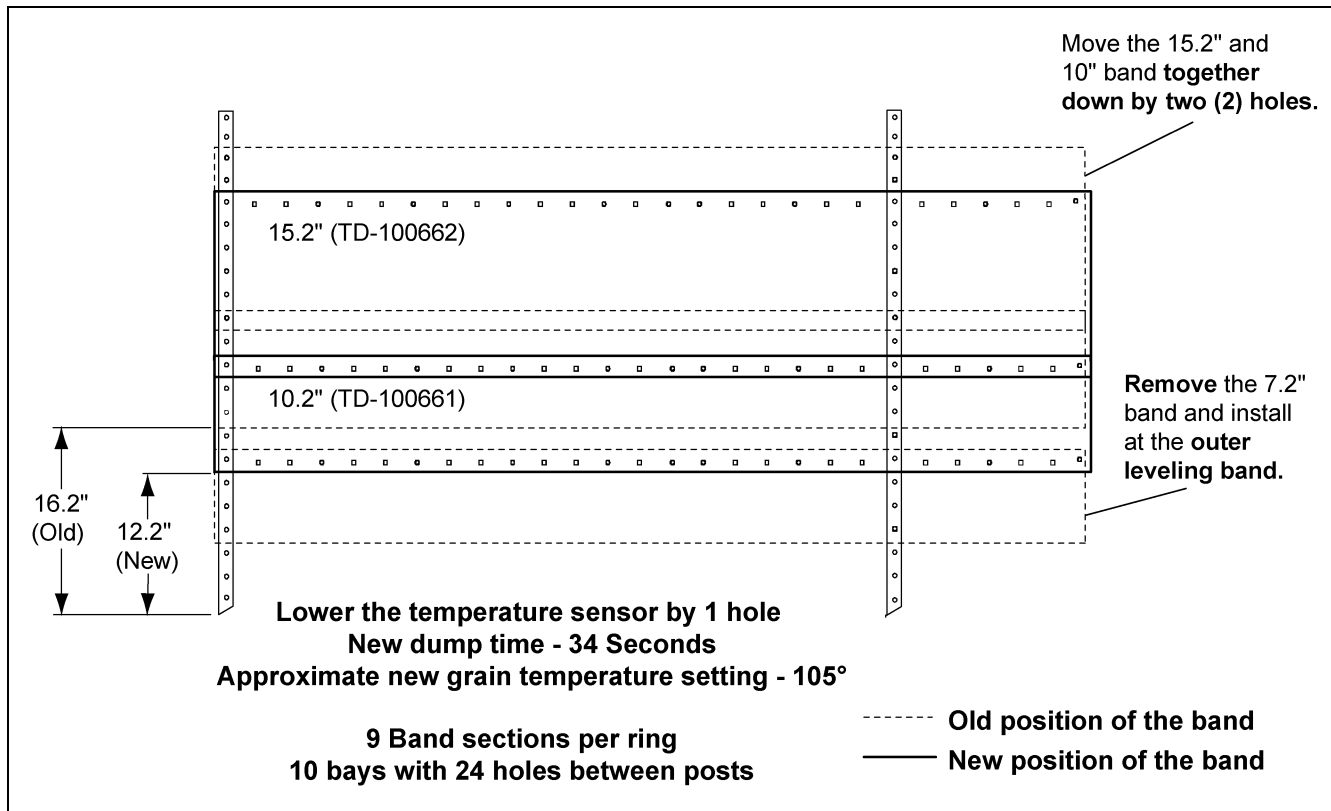

Figure 7

Positioning the Top Dry Leveling Bands

30' Leveling Band Locations

Inner Leveling Bands

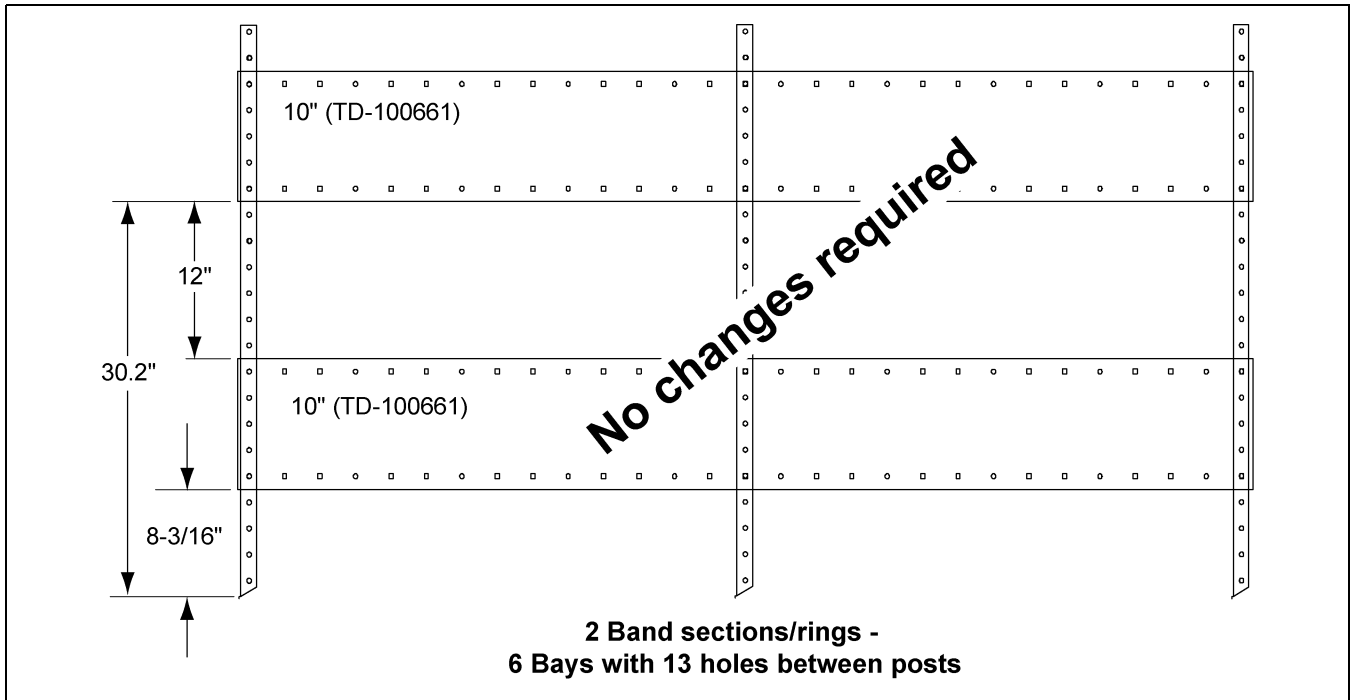

Figure 8

Middle Leveling Bands

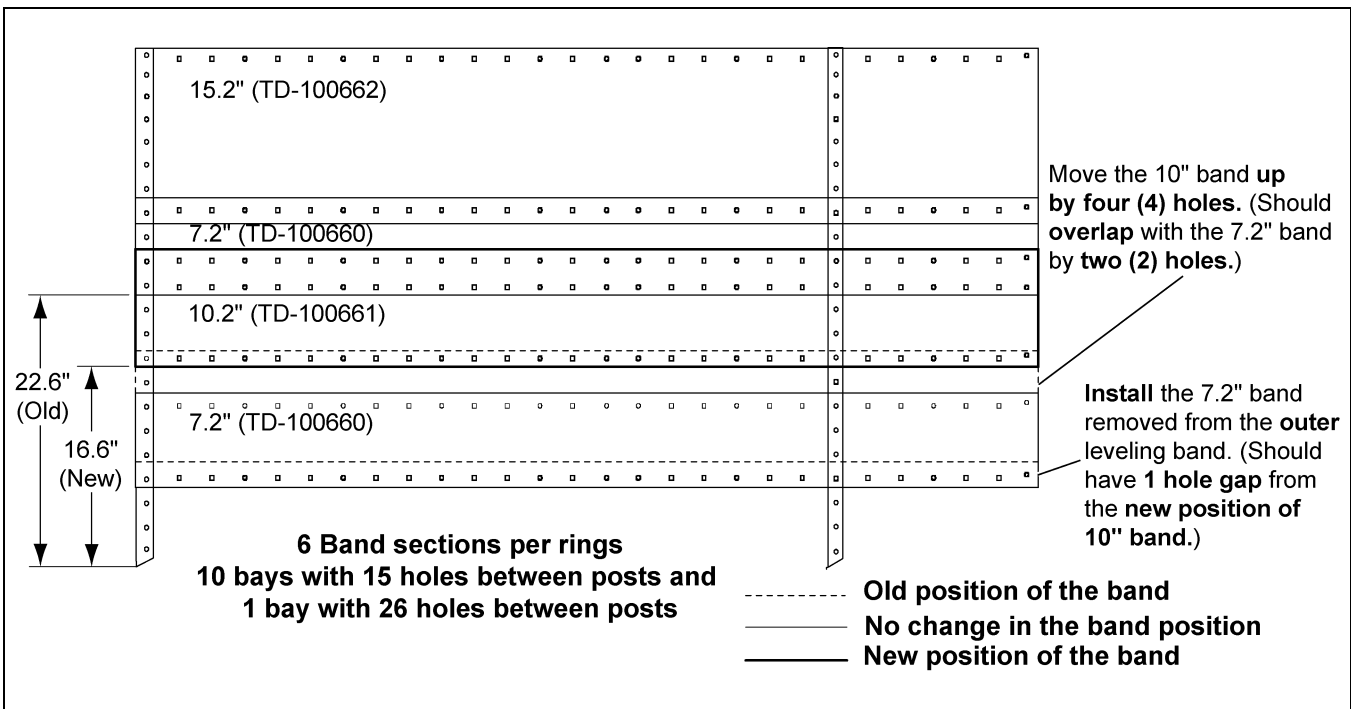

Figure 9

30' Leveling Band Locations (Continued)

Outer Leveling Bands

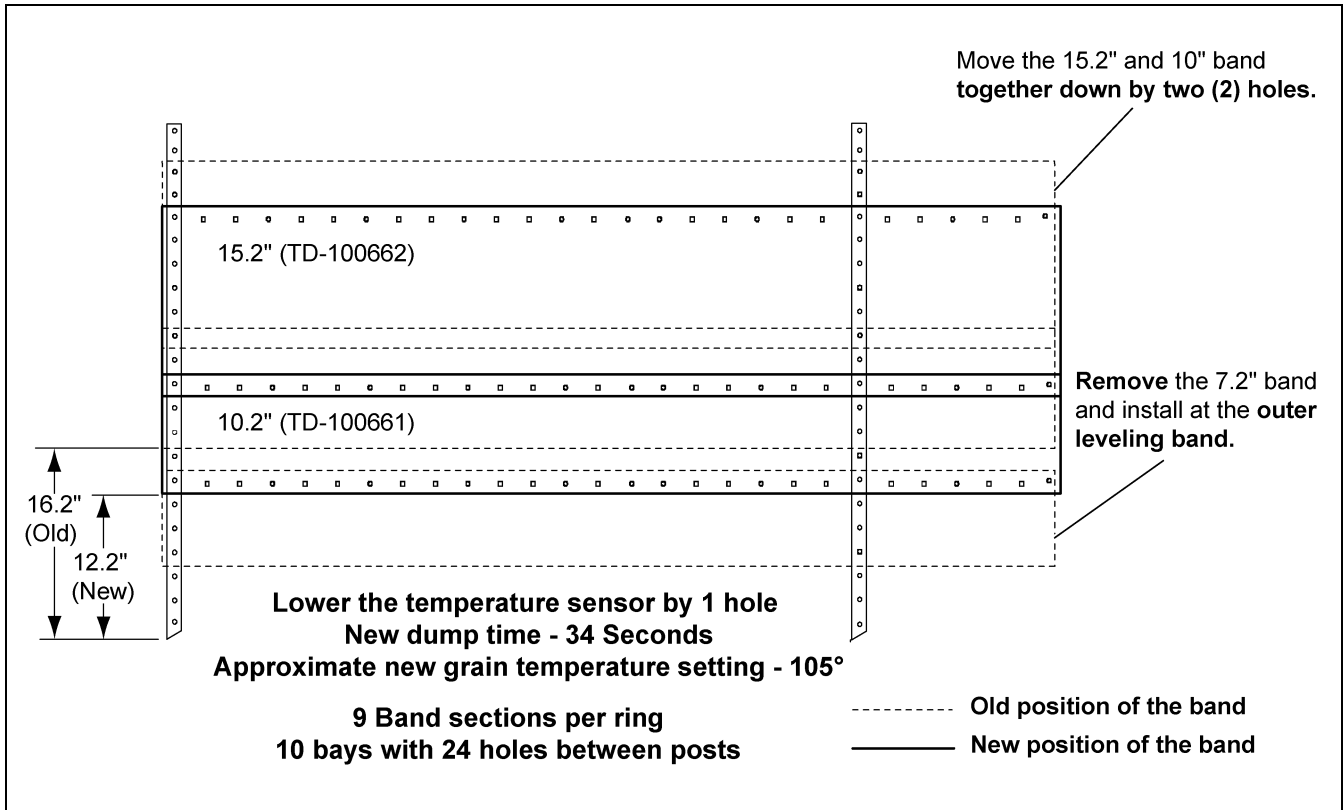

Figure 10

Positioning the Top Dry Leveling Bands

36' Leveling Band Locations

Inner Leveling Bands

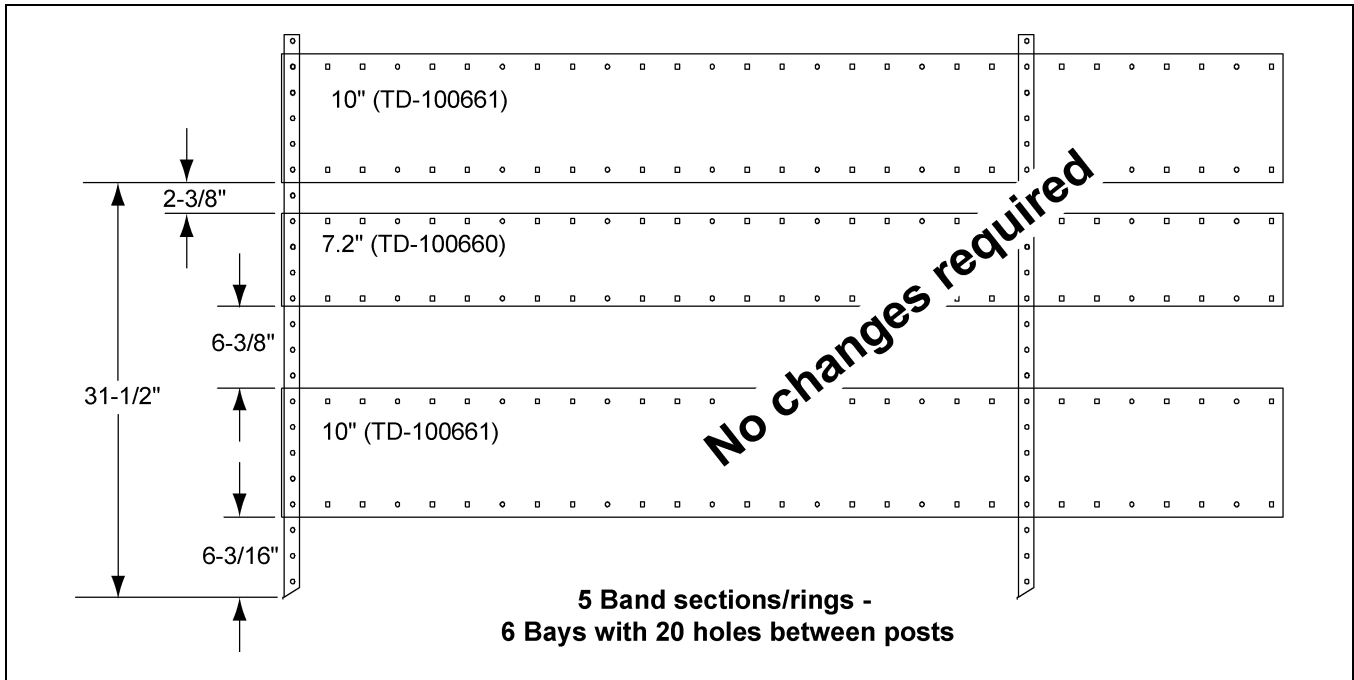

Figure 11

Number 2 Set of Leveling Bands

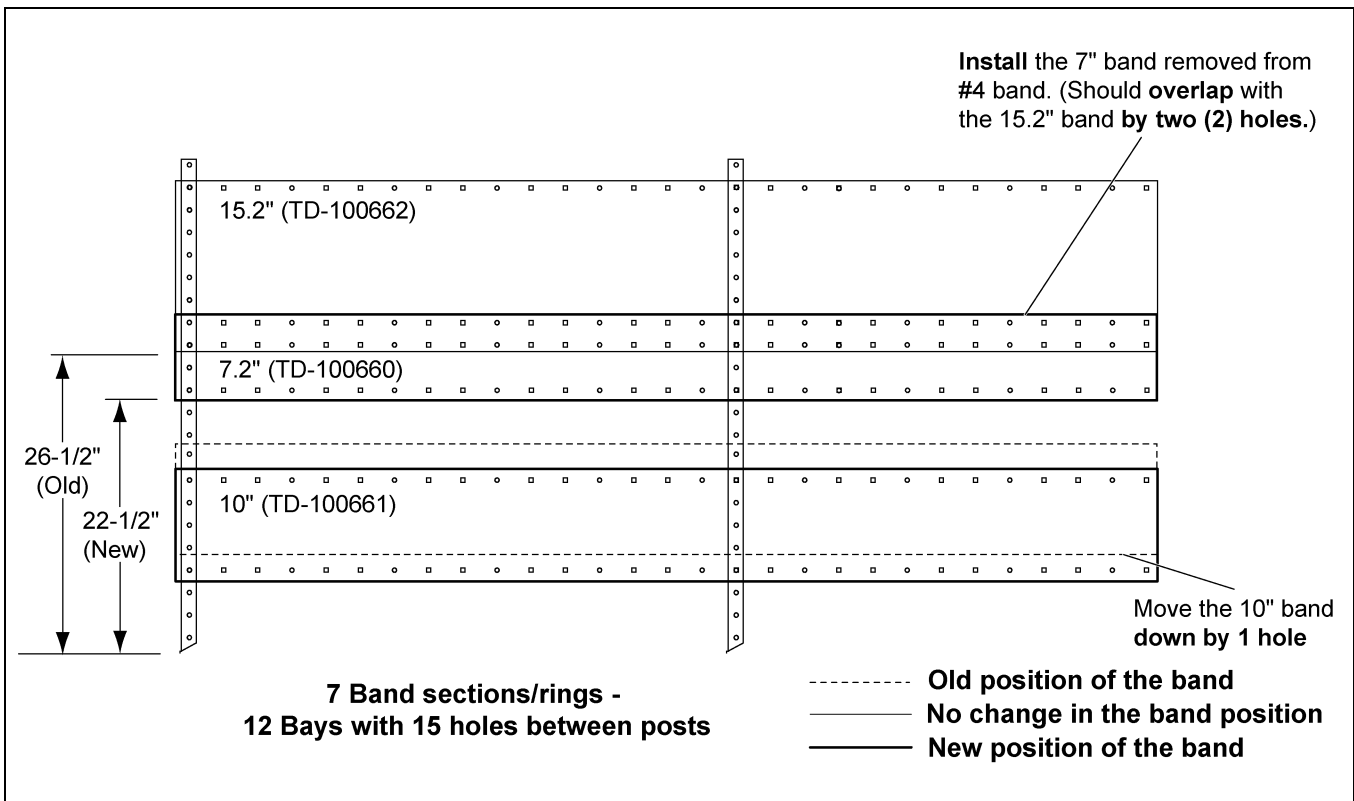

Figure 12

36' Leveling Band Locations (Continued)

Number 3 Set of Leveling Bands

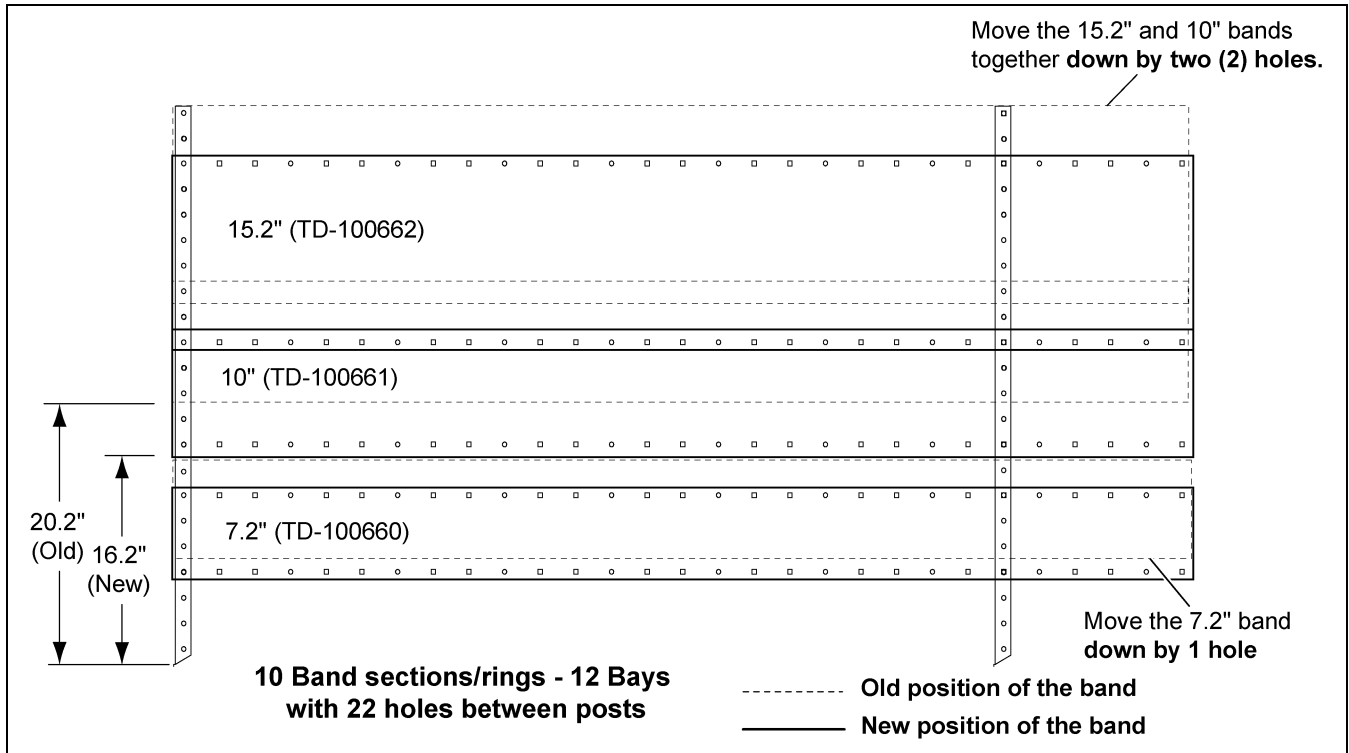

Figure 13

Number 4 Set of Leveling Bands

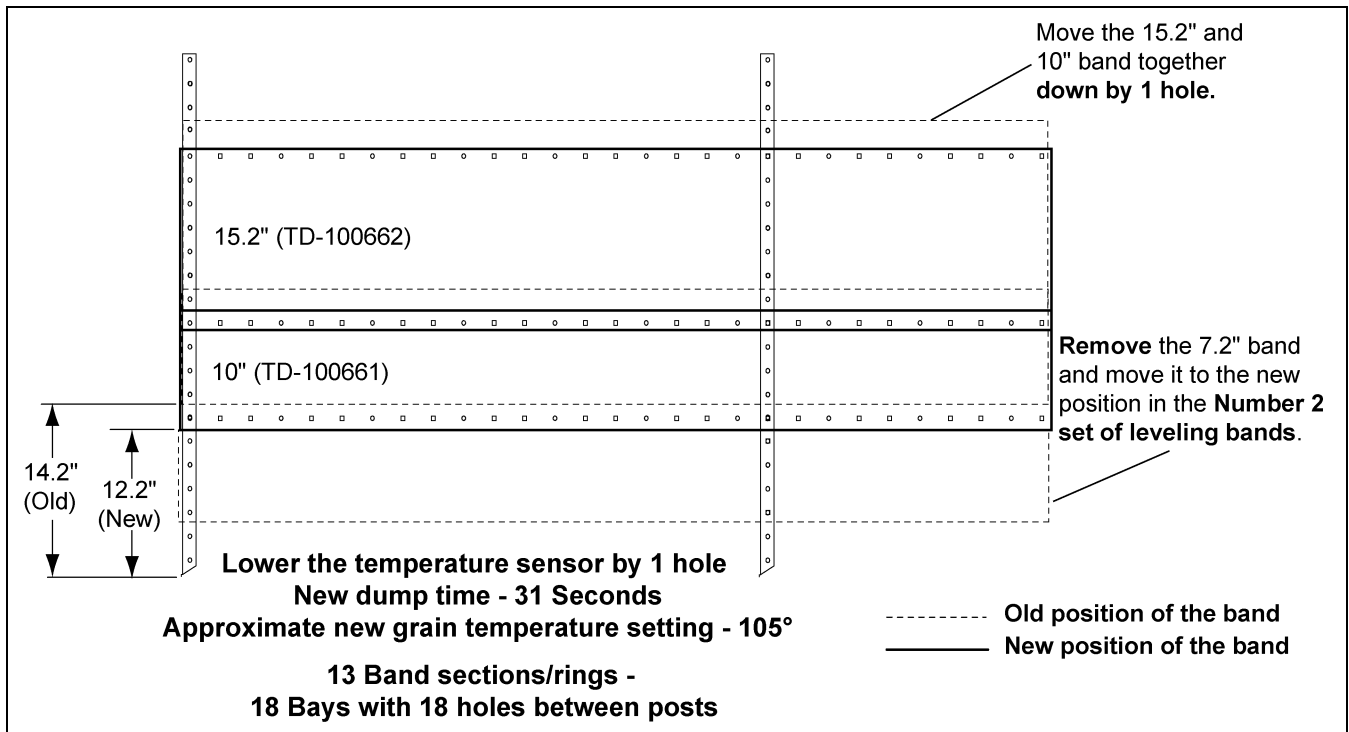

Figure 14