



14' Rolled I-Beam Assembly

The rolled I-beam assembly is a two (2) piece design and will need to be spliced together with splice plates.

1. Locate each half of the rolled I-beam (A) and install the web splice plate (C) to the inside seam on the rolled I-beam (A) with the flange bolts (D) and the flange nuts (E).
2. Install the flange splice plates (B) to the top and bottom side of the rolled I-beam (A) seams and install the flange bolts (D) and flange nuts (E). (See Figure 1.)

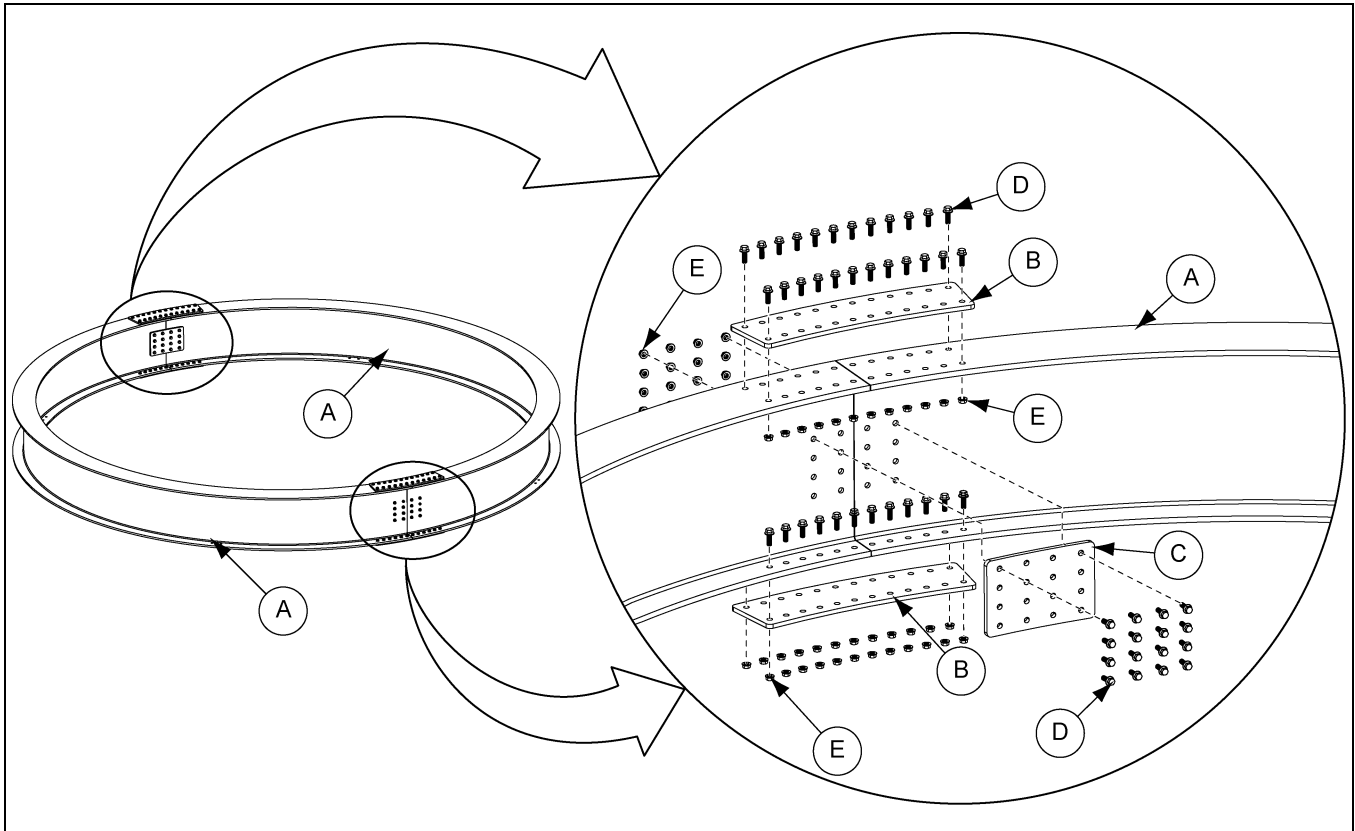

Figure 1

Ref #	Part #	Description	Qty
A	CTR-1357	Rolled I-Beam	2
B	CTR-1359	Flange Splice Plate	4
C	CTR-1358	Web Splice Plate	2
D	S-10252	Flange Bolt 1/2"-13 x 1-3/4" YDP Grade 8 or 8.2	128
E	S-10253	Flange Nut 1/2"-13 x 1-3/4" YDP Grade 8	128

Date: 01-29-15



14' Rolled I-Beam Peak Cap Extension for Conveyors

14' Rolled I-Beam Installation

1. Place the assembled rolled I-beam (A) on the four (4) stand-off weldments (F) on the cap plates.

NOTE: Make sure that the splices in the rolled beam are oriented as shown in [Figure 3](#) with respect to the seams in the center collar cap plates.

2. Install the rolled I-beam assembly (A) on the stand-off weldments (F) with the flange bolts (D) and flange nuts (E). ([See Figure 2.](#))

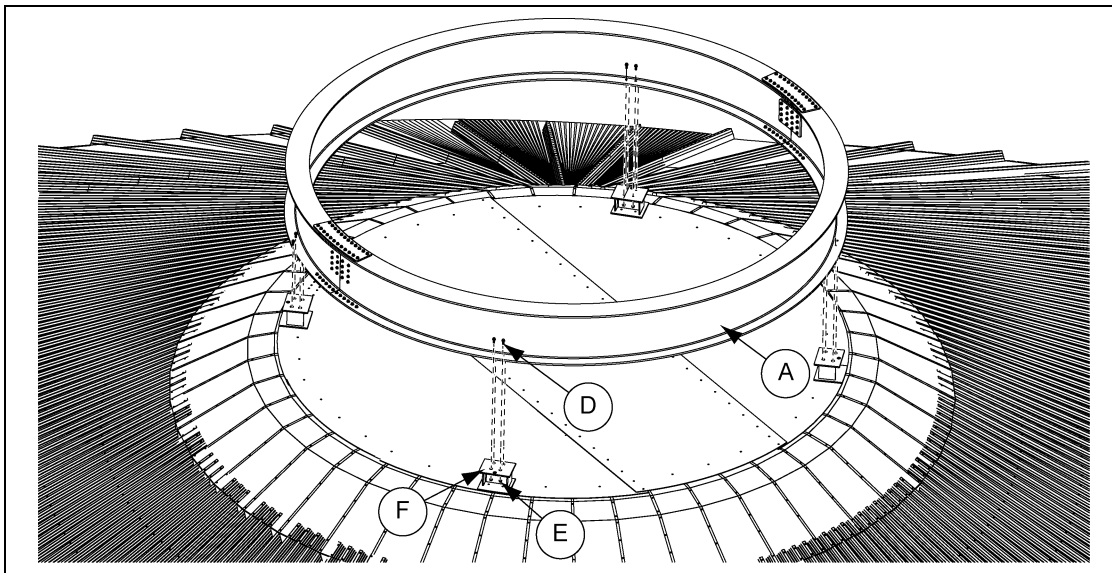

Figure 2

Ref #	Part #	Description	Qty
A	CTR-1357	Rolled I-Beam	2
D	S-10252	Flange Bolt 1/2"-13 x 1-3/4" YDP Grade 8 or 8.2	16
E	S-10253	Flange Nut 1/2"-13 x 1-3/4" YDP Grade 8	16
F	CTR-1337	Stand-Off Weldments	4

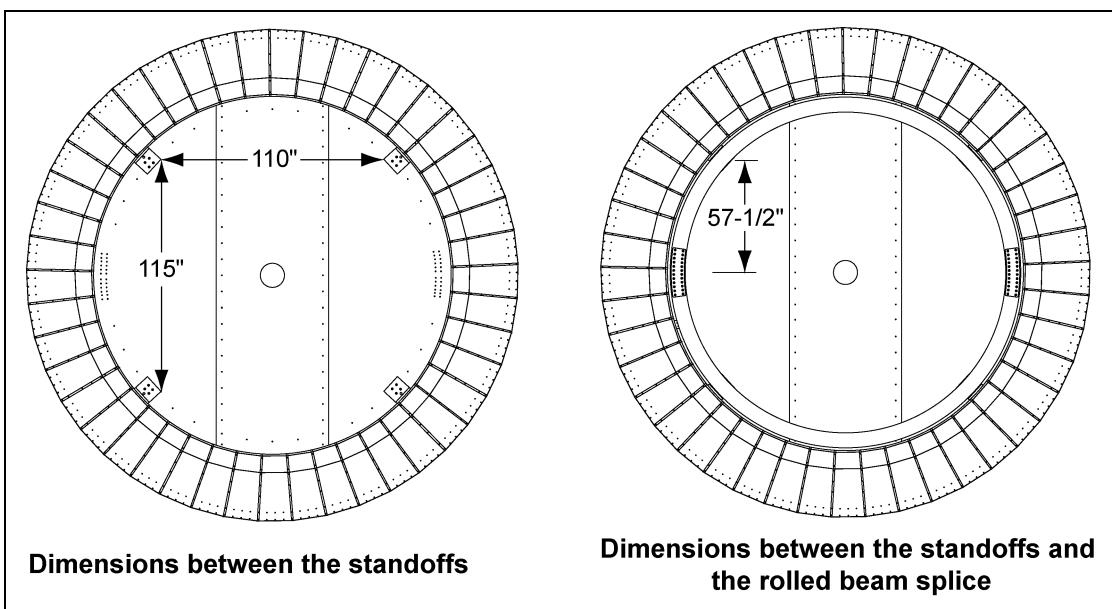

Figure 3