



TM-Series Tower Dryer

Operation Manual

PNEG-1707

Date: 10-09-09

GSI GROUP



PNEG-1707

All information, illustrations, photos, and specifications in this manual are based on the latest information available at the time of publication. The right is reserved to make changes at any time without notice.

Contents

Chapter 1 Safety	5
Safety Guidelines	5
Dryer Operation	6
Emergency Stop Switch	6
Operating Precautions	7
Chapter 2 Safety Decals	9
Chapter 3 Specifications	11
Modular Tower Dryer Specifications	11
Dimensions	12
Chapter 4 Dryer Installation	14
Dryer Layout	14
Liquid Propane (LP) Dryers with Internal Vaporizers	14
Natural Gas (NG) Dryers	14
Modular Base Layout	15
Central United States Foundation Plan	16
Northern United States Foundation Plan	17
Fuel Supply	18
Electrical Power Supply	19
Transformers and Wiring Voltage Drop	19
Power Supply Disconnect	20
Machine to Earth Grounding	21
Proper Installation of Ground Rod	21
Connecting Auxiliary Conveyors	21
Chapter 5 Operating Controls	22
Vision Control Panel Layout	22
Control Power Switch	22
Fan Switch	22
Heater Switch	23
Load Auger Switch	23
Unload Switch	23
Outside Light Switch	23
Start Switch	23
Stop Switch	23
Chapter 6 Vision Touch Screen Display	24
Boot Screen	24
Default Operation Screen	24
Setting the Timers	25
Setting the Temperatures	26
The Setup Screen	28

Table of Contents

Chapter 7 Test Firing	34
Dryer Checks	34
Inspect the Accutrol Metering System	34
Electrical Power	34
Control Power Switch	34
Start Switch	34
Fuel Check	34
Load Auger	34
Unload Auto Operation	35
Unload Manual Operation	35
Accutrol Sweep Metering System Operation	35
Fan Switch	35
Burner Safety	35
Burner Test Fire	35
Dryer Shut Down	36
Emergency	36
Chapter 8 Dryer Operation	37
Dryer Start-up	37
Dryer Shut Down	38
Moisture Control Setup	39
Chapter 9 Drying Time Tables	43
Drying Time Table.....Model 1008	43
Drying Time Table.....Model 1010	44
Drying Time Table.....Model 1012	46
Drying Time Table.....Model 1015	47
Chapter 10 Service	49
Pre-seasonal Inspection and Service	49
Seasonal Inspection and Service	49
Pre-season Service Check List	51
End of Season Shut Down Procedure	51
Chapter 11 Safety Circuit Shut Down Messages	53
Fan/Heater Generated Errors	53
Input/Output Generated Errors	55
Master Display Generated Errors	56
Chapter 12 Wiring Diagrams	58
Power Box Back Panel Wiring	58
Fan/Heater Board Wiring	61
Main Input/Output Power Box Wiring	62
Top Terminal Strip Power Box	63
Bottom Terminal Strip Power Box	64
Burner Control Wiring	65
DC Motor Wiring	66
Fan Contactor and Overload (ACL)	67
Fan Contactor Part Winding Starter	68
Fan Contactor Soft Starter	69
Moisture Sensor Wiring	70
Chapter 13 Warranty	71

Safety Guidelines

This manual contains information that is important for you, the owner/operator, to know and understand. This information relates to protecting **personal safety** and **preventing equipment problems**. It is the responsibility of the owner/operator to inform anyone operating or working in the area of this equipment of these safety guidelines. To help you recognize this information, we use the symbols that are defined below. Please read the manual and pay attention to these sections. Failure to read this manual and its safety instructions is a misuse of the equipment and may lead to serious injury or death.



This is the safety alert symbol. It is used to alert you to potential personal injury hazards. Obey all safety messages that follow this symbol to avoid possible injury or death.



DANGER indicates an imminently hazardous situation which, if not avoided, will result in death or serious injury.



WARNING indicates a potentially hazardous situation which, if not avoided, could result in death or serious injury.



CAUTION indicates a potentially hazardous situation which, if not avoided, may result in minor or moderate injury.



CAUTION used without the safety alert symbol indicates a potentially hazardous situation which, if not avoided, may result in property damage.



NOTE indicates information about the equipment that you should pay special attention.

Dryer Operation

Thank you for choosing a GSI product. It is designed to give excellent performance and service for many years.

This manual describes the operation for all standard production model dryers. These dryers are available with liquid propane or natural gas fuel supply and 3 phase 230, 380, 460, or 575 volts (50 Hz or 60 Hz) electrical power.

Our foremost concern is your safety and the safety of others associated with this equipment. We want to keep you as a customer. This manual is to help you understand safe operating procedures and some problems which may be encountered by the operator and other personnel.

As owner and/or operator, it is your responsibility to know what requirements, hazards and precautions exist, and to inform all personnel associated with the equipment or in the area. Safety precautions may be required from the personnel. Avoid any alterations to the equipment. Such alterations may produce a very dangerous situation where **SERIOUS INJURY** or **DEATH** may occur.

This equipment shall be installed in accordance with the current installation codes and applicable regulations which should be carefully followed in all cases. Authorities having jurisdiction should be consulted before installations are made.

Emergency Stop Switch

The Emergency Stop switch is located on the upper control box door. Pushing the Emergency Stop switch will interrupt the control power and stop all dryer functions.



Pushing the Emergency Stop switch does not interrupt the main power to the upper control box panel.

Operating Precautions

READ THESE INSTRUCTIONS BEFORE INSTALLATION AND OPERATION SAVE FOR FUTURE REFERENCE

1. Read and understand the operations manual before attempting to operate the unit.
2. Keep ALL guards, safety decals, and safety devices in place. **NEVER** operate dryer while guards are removed.
3. Keep visitors, children and untrained personnel away from dryer at all times.
4. Never attempt to operate the dryer by jumping or otherwise bypassing any safety devices on the unit.
5. Always set the main power supply disconnect switch to OFF and lock it in the OFF position using a padlock before performing any service or maintenance work on the dryer or the auxiliary conveyor equipment.
6. Keep the dryer and wet holding equipment CLEAN. **DO NOT** allow fine material to accumulate.
7. On LP fired units, set pressure regulator to avoid excessive gas pressure applied to a burner during ignition and when the burner is in operation. Do not exceed maximum recommended drying temperatures.
8. **DO NOT** operate the dryer if any gas leak is detected. Shut down and repair before further operation.
9. Clean grain is safer and easier to dry. Fine materials can be highly combustible, and it also requires removal of extra moisture.
10. Use **CAUTION** in working around high-speed fans, gas burner, augers and auxiliary conveyors which can **START AUTOMATICALLY**.
11. Be certain that capacities of auxiliary conveyors are matched to dryer metering capacities.
12. **DO NOT** operate in an area where combustible material will be drawn into the dryer.
13. The operating and safety recommendations in this manual pertain to the common cereal grains as indicated. When drying any other grain or products, consult the factory for additional recommendations.
14. Routinely check for any developing gas plumbing leaks.
15. Before attempting to remove and reinstall the fan blade, contact GSI for the recommended procedure.

Use Caution in the Operation of this Equipment

This dryer is designed and manufactured with operator safety in mind. However, the very nature of a grain dryer having a gas burner, high voltage electrical equipment and high speed rotating parts, presents hazards to personnel which cannot be completely safeguarded against without interfering with the efficient operation of the dryer and reasonable access to its components.

Use extreme caution in working around high speed fans, gas-fired heaters, augers and auxiliary conveyors, which may start without warning when the dryer is operating on automatic control.



Keep the dryer clean. Do not allow fine material to accumulate in the plenum chamber or surrounding the outside of the dryer.

Continued safe, dependable operation of automatic equipment depends, to a great degree, upon the owner. For a safe and dependable drying system, follow the recommendations within the Owner's Manual and make it a practice to regularly inspect the unit for any developing problems or unsafe conditions.

Take special note of the [Operating Precautions](#) before attempting to operate the dryer.

1. Safety

Prepare for Emergencies

Be prepared if fire starts.

Keep a first aid kit and fire extinguisher handy.

Keep emergency numbers for doctors, ambulance service, hospital and fire department near your telephone.

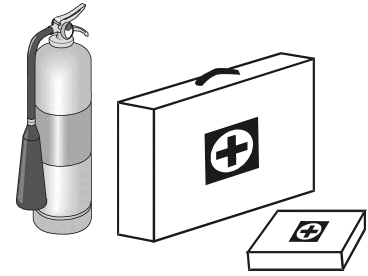

Keep Emergency Equipment Quickly Accessible

Wear Protective Clothing

Wear close fitting clothing and safety equipment appropriate to the job.

Remove all jewelry.

Long hair should be tied up and back.

Safety glasses should be worn at all times to protect eyes from debris.

Wear gloves to protect your hands from sharp edges on plastic or steel parts.

Wear steel toe boots to help protect your feet from falling debris. Tuck in any loose or dangling shoe strings.

A respirator may be needed to prevent breathing potentially toxic fumes and dust.

Wear hard hat to help protect your head.

Wear appropriate fall protection equipment when working at elevations greater than six feet (6').

Eye Protection

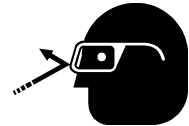

Gloves



Steel Toe Boots



Respirator



Hard Hat



Fall Protection



Contact the local power company to have a representative survey the installation to assure the wiring is compatible with their system and adequate power is supplied to the unit. Safety decals should be read and understood by all people in the grain handling area. **Inspect all decals and replace any that are illegible, worn, or missing. Contact your dealer or the factory to order replacement decals.**

If a decal is damaged or is missing, contact:

GSI Decals

1004 E. Illinois St.
Assumption, IL. 62510
Phone: 1-217-226-4421

A free replacement will be sent to you.

NOTE: *Decals are not shown actual size.*

	<p>Decal: DC-1224</p> <p>Decal DC-1224 is located in two places on the fan/heater control box. One on the lid and one on the front of the fan heater control box. Another location for this decal is inside the upper control box for the dryer.</p>
	<p>Decal: DC-889</p> <p>Decal DC-889 has two locations. One inside the fan/heater control box and another on the dryer upper control box door next to the main power disconnect.</p>

2. Safety Decals



Decal: DC-1061

Decal DC-1061 is located on the outside of the heat section door.

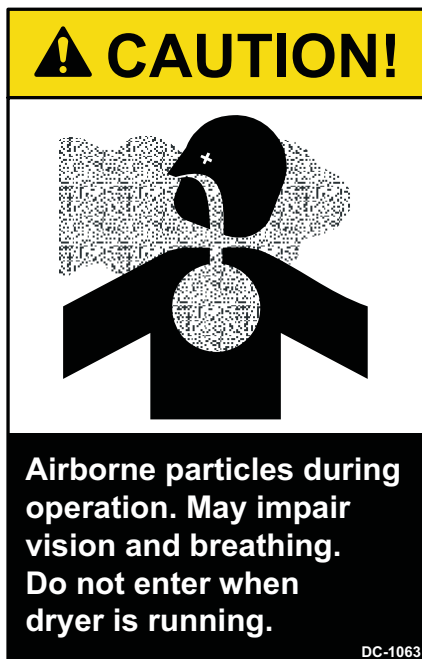

Decal: DC-1063

Decal DC-1063 is located on the louvered access door to the cooling section of the dryer.



Decal: DC-1062

Decal DC-1062 is located inside the cooling section of the dryer on the two access doors to the metering section.



Decal: DC-1064

Decal DC-1064 is located on the louvered access door to the cooling section of the dryer.

Modular Tower Dryer Specifications

Models	TM-1008	TM-1010	TM-1012	TM-1015
Blower Size	43" Axial	43" Axial	43" Axial	48" Axial
Blower RPM	1775	1775	1775	1775
Blower HP	40	50	60	75
Metering HP	1	1	1	1
Drying CFM	38000	45000	52000	66000
Cooling CFM	19500	22500	26000	33000
Burner Capacity (mBtu) ²	8.2	9.7	11.2	14.3
Average Heat Use (mBtu)	5.1	6.1	7.0	8.9
Grain Column	12-3/4"	12-3/4"	12-3/4"	12-3/4"
Tower Diameter ¹	10'-7"	10'-7"	10'-7"	10'-7"
Overall Height	42'-1"	48'-11"	55'-9"	62'-7"
Wet Holding (BU)	260	260	260	260
Maximum Heat Holding (BU)	552	726	900	1074
Minimum Heat Holding (BU)	450	624	798	972
Maximum Cool Holding (BU)	246	246	289	289
Minimum Cool Holding (BU)	144	144	187	187
Dryer Holding (BU)	1049	1223	1397	1571
Outside Catwalks	1	2	3	3
BPH (20%-15%) Maximum Cooling	800	1000	1200	1500
BPH (25%-15%) Maximum Cooling	480	600	720	900
BPH (20%-15%) Minimum Cooling*	900	1125	1350	1690
BPH (25%-15%) Minimum Cooling*	540	675	810	1010

¹ Dimensions exclude outside catwalk.

² Capacities listed are wet bushels/tonnes, shelled corn at listed moisture content and are estimates based on drying principles, field results and computer simulation. Variance may occur due to grain's physiological factors (kernel size, chemical composition, variety, maturity), excessive fines, adverse weather conditions, etc.

* Minimum cooling capacities with cooling floor set in the lower position and assumes utilization of cooling in bin (dryeration).

Dimensions

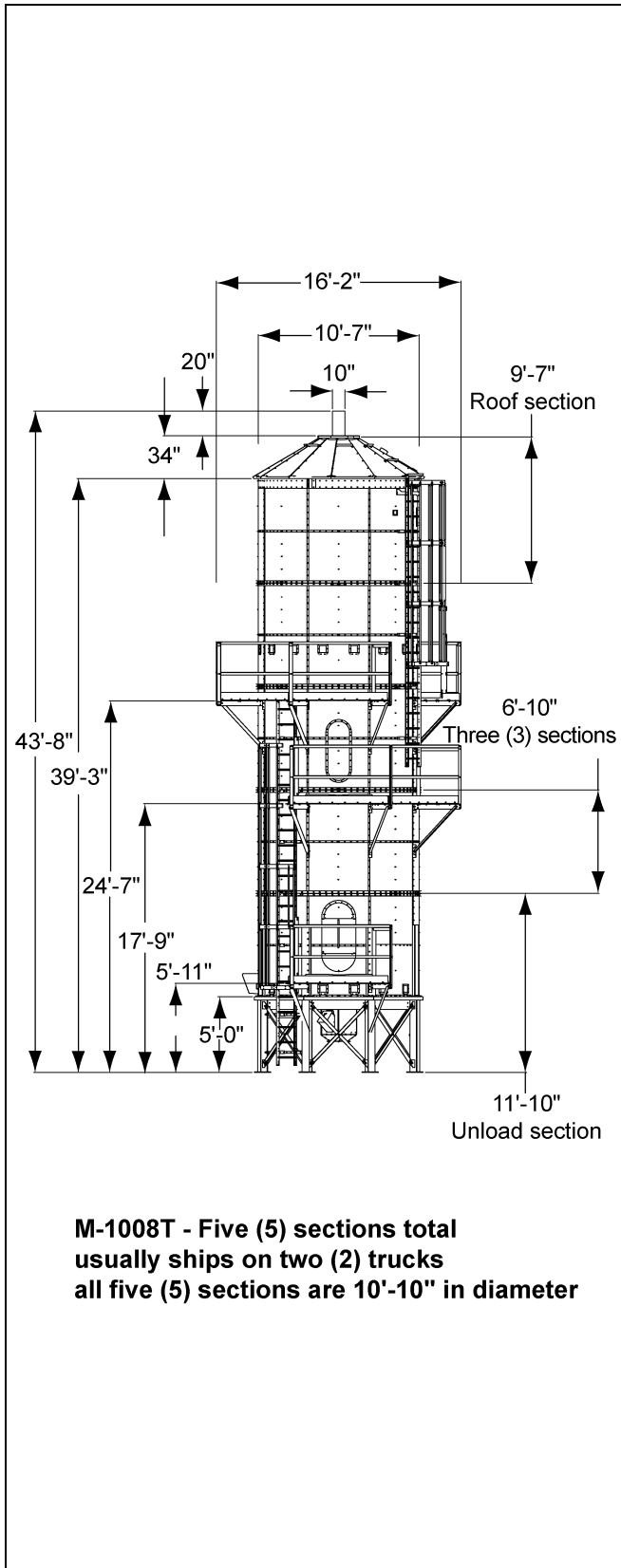

Figure 3A M-1008T

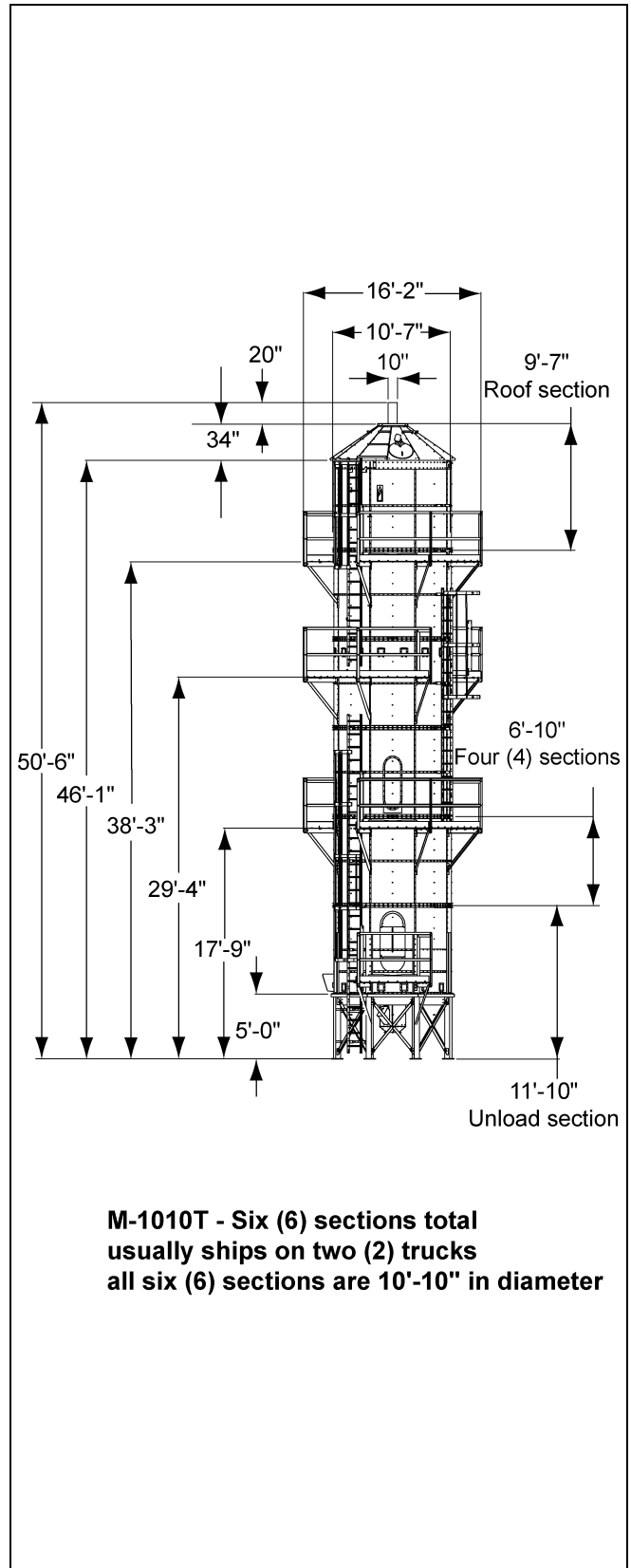

Figure 3B M-1010T

Dimensions (Continued)

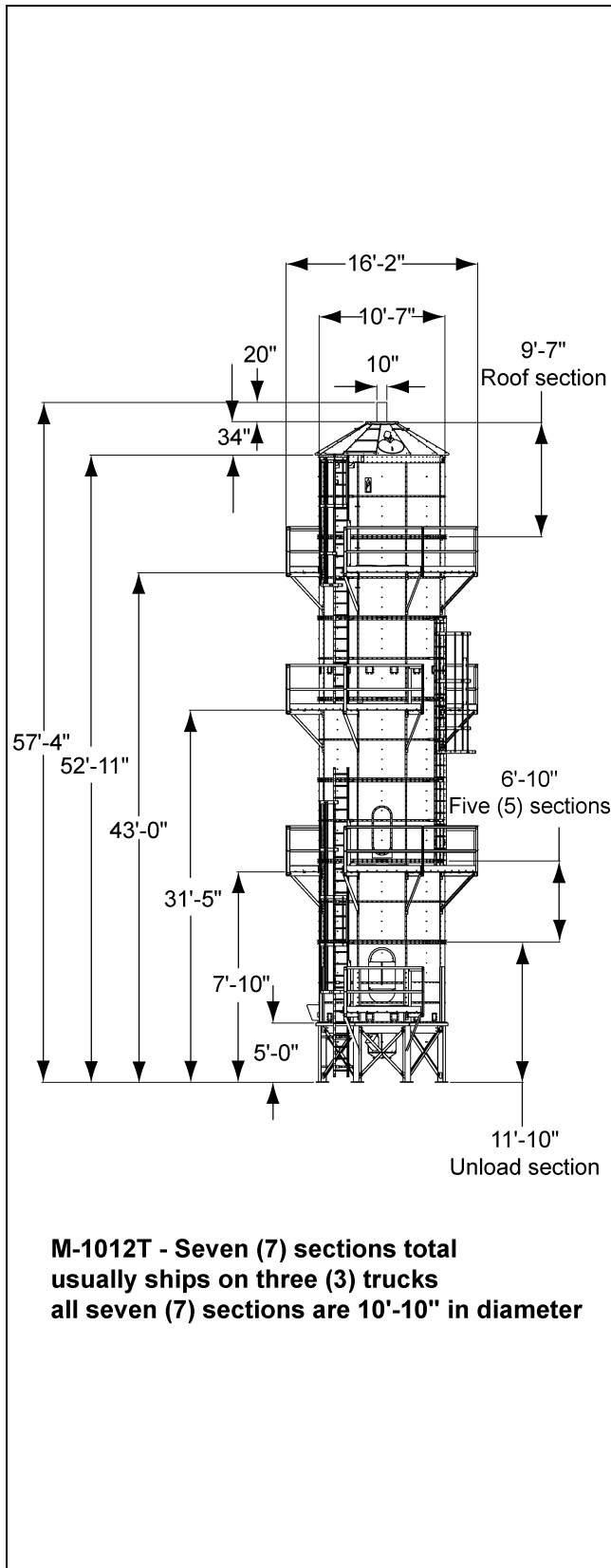

Figure 3C M-1012T

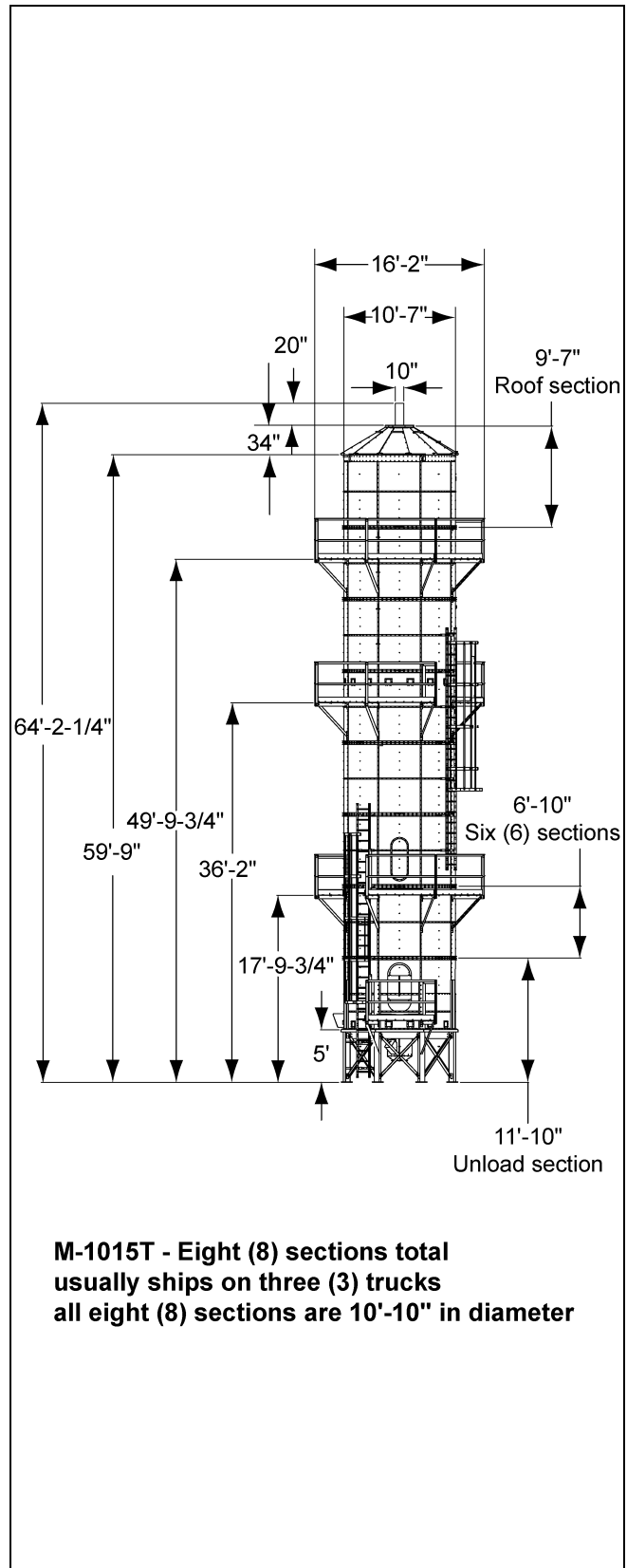

Figure 3D M-1015T

Dryer Layout

System Layout

Consider the grain handling system and location of storage bins and existing conveyors when selecting dryer site, to facilitate wet grain supply and dry grain discharge to conveyors. Other considerations are prevailing wind direction, fuel and power supply locations, noise and convenience of control location.

Site Location

The dryer should not be operated inside a building or in any area not permitted by electrical code, fuel installation regulations, or insurance requirements. Do not operate in an area where combustible material can be drawn into the dryer. Maintain a minimum distance of five feet (5') to other structures. Refer to dryer specifications [on Page 11](#) and dimensions [on Pages 12 and 13](#).

Foundation

The dryer should be placed on a reinforced concrete slab located in a well drained area. [See Figure 4A on Page 15](#), [See Figure 4B on Page 16](#) and [Figure 4C on Page 17](#) for recommended dryer foundations for soils with minimum soil bearing pressure of 3000 lbs/ft².

Liquid Propane (LP) Dryers with Internal Vaporizers

Liquid Draw

The dryer is designed to operate on liquid propane, with liquid draw from the supply tank. A piping system is provided on the dryer, including strainer, pressure relief valve, and manual shut off valve. ([See Figure 4D on Page 18.](#))

Ammonia Tanks

Do not use propane supply tanks which have previously contained ammonia or fertilizer solutions. These substances are extremely corrosive and damaging to fuel supply and burner parts.

Oil or Water in Tanks

With liquid draw from the supply tank, any water present in the tank may freeze in the piping and controls in cold weather. To ensure that tanks are free of moisture, the usual precaution is to purge with methanol. Avoid tanks which may contain an accumulation of oil or heavy hydrocarbons from long use on a vapor withdrawal system.

Natural Gas (NG) Dryers

Gas Volume and Pressure

The dryer is designed to operate on natural gas having a heat value of about 1000 BTU per cubic foot. The dryer is equipped with a natural gas supply pipe system connected to the heater solenoid valves. A regulated pressure of 10 PSI must be provided at the connection to the dryer, with gas available in sufficient volume to maintain operating pressure. ([See Figure 4E on Page 18.](#))

Modular Base Layout

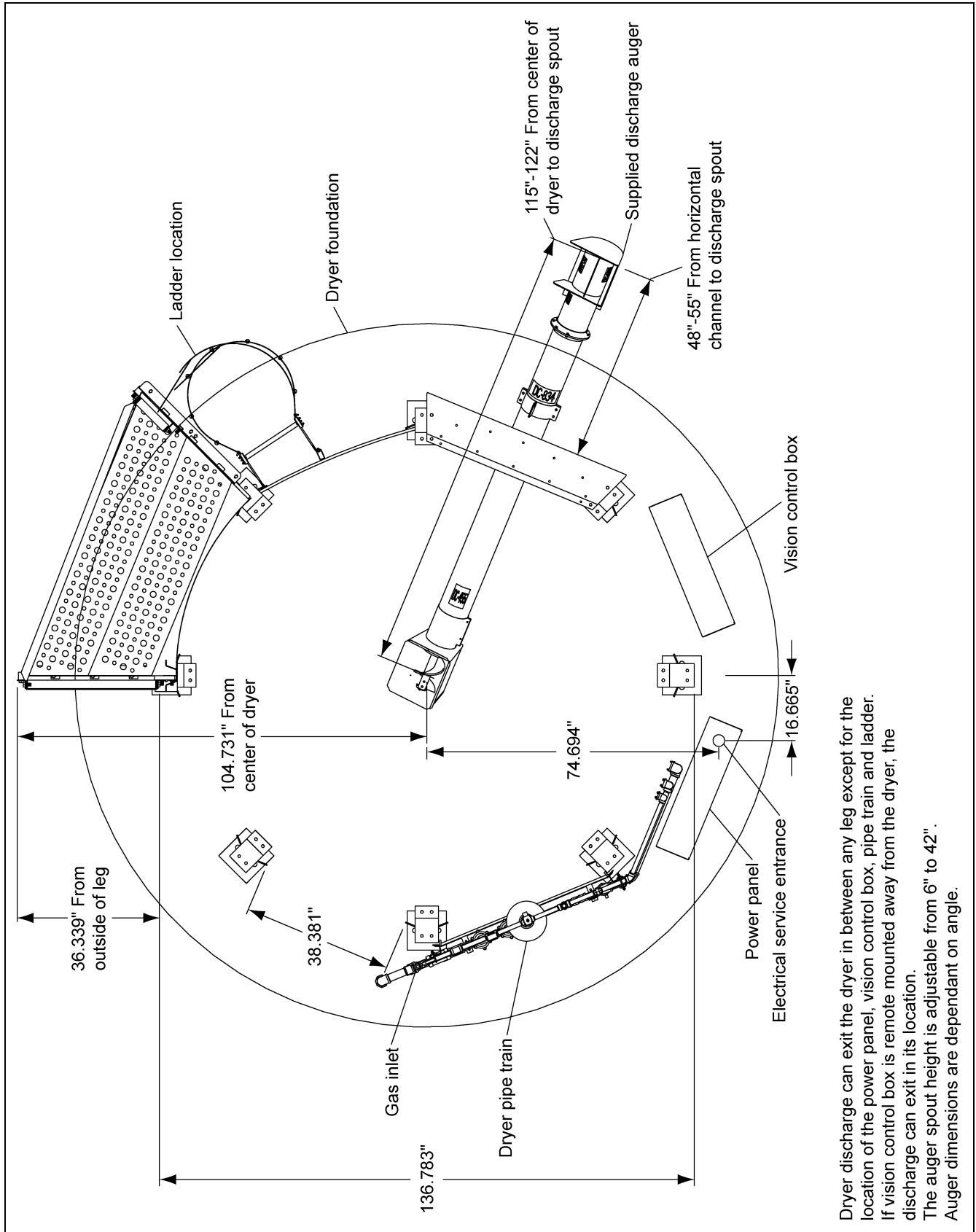

Dryer discharge can exit the dryer in between any leg except for the location of the power panel, vision control box, pipe train and ladder. If vision control box is remote mounted away from the dryer, the discharge can exit in its location. The auger spout height is adjustable from 6" to 42". Auger dimensions are dependant on angle.

Figure 4A

Central United States Foundation Plan

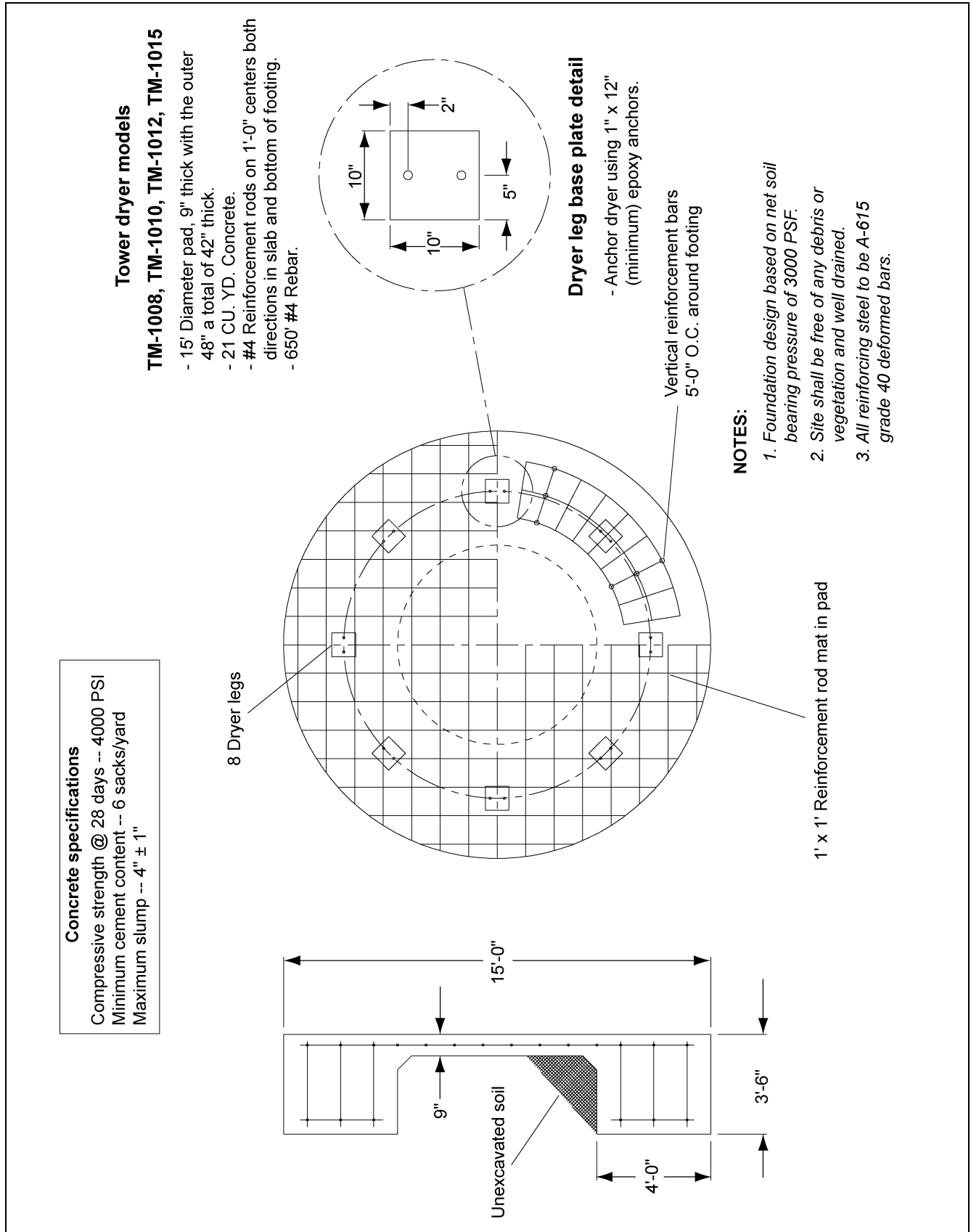

Figure 4B

Northern United States Foundation Plan

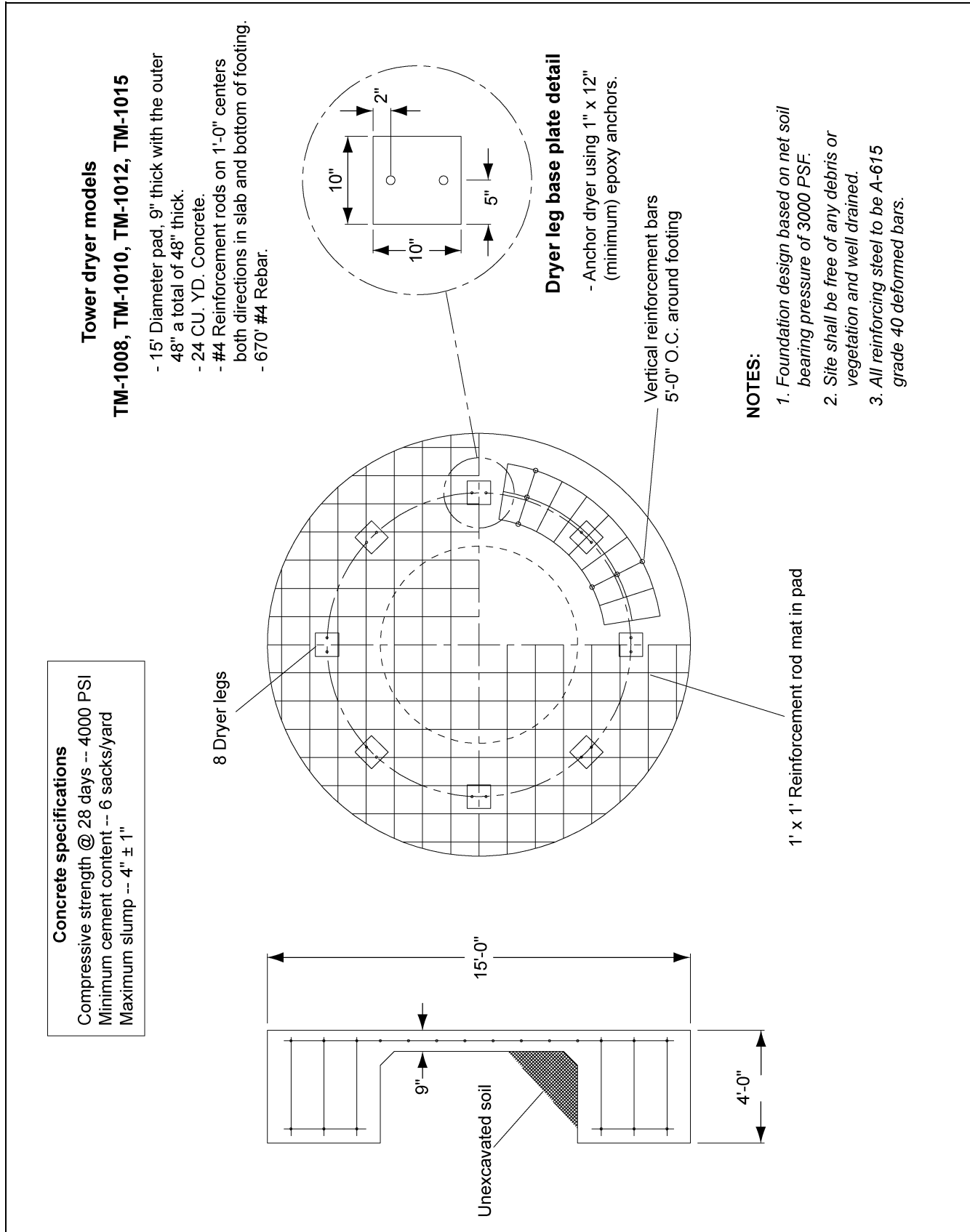

Figure 4C

Fuel Supply

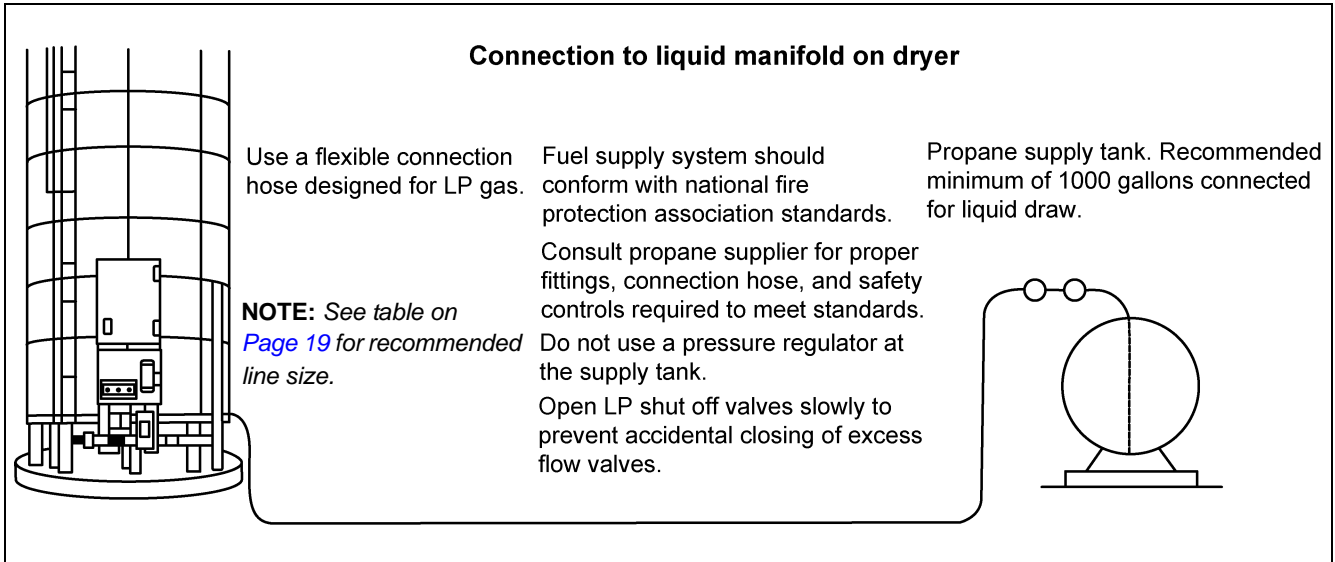

Figure 4D *Liquid Propane (LP) Fuel Supply*

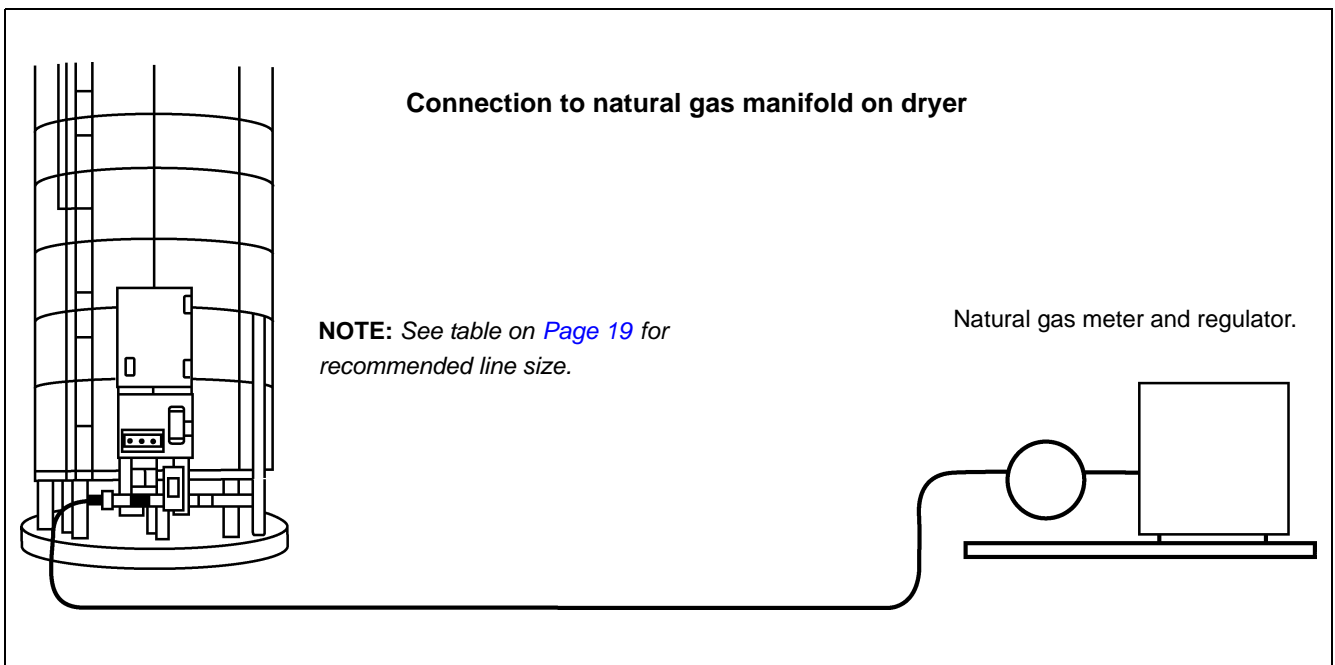

Figure 4E *Natural Gas (N) Fuel Supply*

Fuel System Requirements

		TM-1008	TM-1010	TM-1012	TM-1015
Liquid Propane	Burner Capacity (Btu/hr) ¹	8,200,000	9,700,000	11,200,000	14,300,000
	Maximum Fuel Usage (gal/hr)	90	106	122	156
	Recommended Liquid Line Size (<100')	3/4"	3/4"	3/4"	3/4"
	Fuel Train Orifice Size (inch)	0.500"	0.625"	0.625"	0.7187"
	Pressure Regulator Setting (lb/in ²)	9	9	9	9
Natural Gas	Burner Capacity (Btu/hr) ¹	8,200,000	9,700,000	11,200,000	14,300,000
	Maximum Fuel Usage (ft ³ /hr)	8200	9700	11200	14300
	Recommended Fuel Line Size (<100')	2"	2"	2"	2-1/2"
	Fuel Train Orifice Size (inch)	0.625"	0.688"	0.688"	0.8125"
	Supplied Pressure to Fuel Train (lb/in ²)	10	10	10	10

¹Burner capacity for fuel line sizing. Actual average fuel usage is typically 50%-60% of the burner capacity.

Electrical Power Supply

An adequate power supply and proper wiring are important factors for maximum performance and long life of the dryer. Electrical service must be adequate enough to prevent low voltage damage to motors and control circuits. (See electrical requirements [on Page 20.](#))

Transformers and Wiring Voltage Drop

Advise the service representative of the local power supplier that an additional load will be placed on the line. Check on KVA rating of transformers, considering total horsepower load. The power supply wiring, main switch equipment and transformers must provide adequate motor starting and operating voltage. Voltage drop during motor starting should not exceed 14% of normal voltage, and after motor is running at full speed it should be within 8% of normal voltage.

4. Dryer Installation

Power Supply Disconnect

All dryers are equipped with a power disconnect switch in the power box to permit total power shut down before opening the power box door, as required for inspection and service. The power disconnect switch is located on the power box door for quick shut down. See table on electrical requirements [below](#) for sizing the electrical service to the dryer.

Electrical Requirements

Dryer Model	Voltage	Motor	HP	Motor Full Load Amps	Dryer Full Load Amps ^{1/}	Main Breaker and Service (Amps)
TM-1008	230V 3 Phase	Fan	40	94	141	200
		Metering System	1 - DC	5		
		Unload Auger	3	8.4		
		Auxiliary (1)	10	28		
	460V 3 Phase	Fan	40	47	76	150
		Metering System	1 - DC	5		
		Unload Auger	3	4.2		
		Auxiliary (1)	10	14		
TM-1010	230V 3 Phase	Fan	50	118	165	300
		Metering System	1 - DC	5		
		Unload Auger	3	8.4		
		Auxiliary (1)	10	28		
	460V 3 Phase	Fan	50	59	88	200
		Metering System	1 - DC	5		
		Unload Auger	3	4.2		
		Auxiliary (1)	10	14		
TM-1012	230V 3 Phase	Fan	60	140	187	300
		Metering System	1 - DC	5		
		Unload Auger	3	8.4		
		Auxiliary (1)	10	28		
	460V 3 Phase	Fan	60	70	99	200
		Metering System	1 - DC	5		
		Unload Auger	3	4.2		
		Auxiliary (1)	10	14		
TM-1015	230V 3 Phase	Fan	75	172	219	400
		Metering System	1 - DC	5		
		Unload Auger	3	8.4		
		Auxiliary (1)	10	28		
	460V 3 Phase	Fan	75	86	115	200
		Metering System	1 - DC	5		
		Unload Auger	3	4.2		
		Auxiliary (1)	10	14		

^{1/} Assumes a 10 HP auxiliary load.

Machine to Earth Grounding

It is very important that a machine to earth ground rod be installed at the dryer. Place the ground rod that comes standard, within eight feet (8') of the dryer and attach it to the dryer control panel with at least a #6 solid, bare, copper ground wire and the clamp provided. The grounding rod located at the power pole will not provide adequate grounding for the dryer. The proper grounding will provide additional safety in case of any short and will ensure long life of all circuit boards, SCR drive, and the ignition system. The ground rod must be in accordance with local requirements.

Proper Installation of Ground Rod

It is not recommended that the rod be driven into dry ground. Follow these instructions for proper installation.

1. Dig a hole large enough to hold one (1) to two (2) gallons of water.
2. Fill hole with water.
3. Insert rod through water and jab it into the ground.
4. Continue jabbing the rod up and down. The water will work its way down the hole, making it possible to work the rod completely into the ground. This method of installation assures good contact with the surrounding soil, making a proper ground.
5. Connect the bare, copper ground wire to the rod with proper clamp.
6. Connect ground wire to control panel with the ground lug provided in the control box.
7. Ground wire must not have any breaks or splices. Insulated wire is not recommended for grounding applications.

Connecting Auxiliary Conveyors

The auxiliary load augers or conveyors can be wired directly to the dryer. The maximum horsepower of auxiliary that can be wired to the dryer is 10 horsepower. If an auxiliary motor is larger than what is recommended, then it must be powered from a source outside the dryer, and must use a separate contractor and overload protection device for each motor. However, the operation of the auxiliaries can be performed by the control panel.

It is recommended that you contact the local power company and have a representative survey the installation to see that the wiring is compatible with their system and that adequate power is supplied to the unit. Remember that the only thing connected to the recommended service amps should be the grain dryer. Standard electrical safety practices and codes should be used. (Refer to National Electrical Code Standard Handbook by National Fire Protection Association.) A qualified electrician should make all electrical wiring installations.

Vision Control Panel Layout

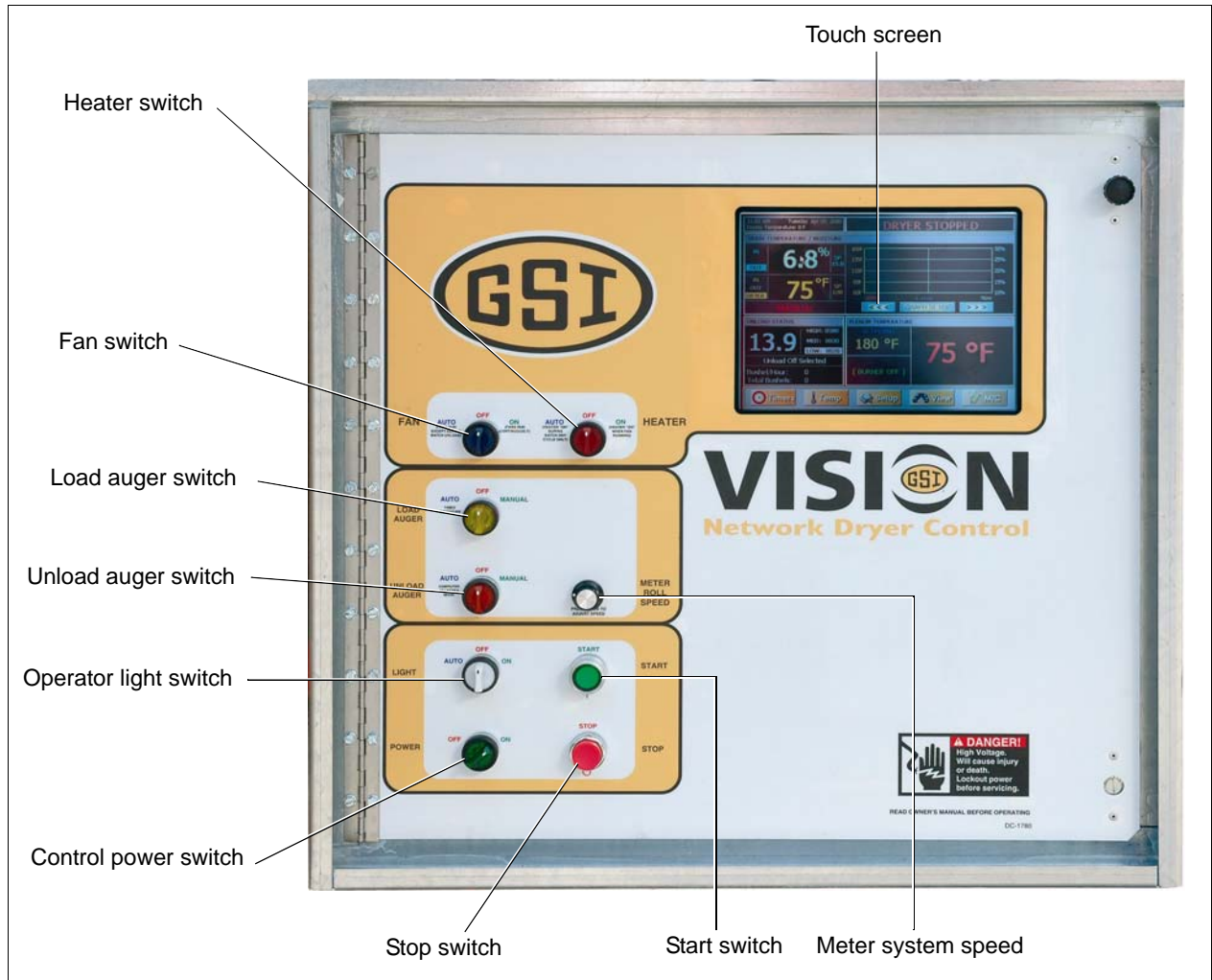

Figure 5A

The vision control system is a state of the art dryer controller used on several GSI drying products. The vision control can operate any dryer in either a batch or a continuous flow mode. All operating instructions for the TM-Series dryer describes **continuous flow** operation only.

Control Power Switch

The vision control system is turned ON or OFF with this switch.

NOTE: This switch does NOT disconnect the power that is present at the breakers, contractors, transformers, fuses or other electrical components found in the control or power box. Turn the main disconnect handle located on the power box to the OFF position prior to servicing any of the installed components.

Fan Switch

The fan is turned ON or OFF with this switch. Turning the switch to the ON position will turn the fan ON. Turning the switch to the OFF position turns the fan OFF. The light inside the switch will illuminate whenever the air pressure sensor senses air movement through the fan. (**NOTE:** The fan AUTO position is not used for continuous flow operation.)

Heater Switch

The burner is turned ON or OFF with this switch. Turning the switch to the ON position will start the burner ignition sequence if the fan is also running. Turning the switch to the OFF position turns the burner OFF. The light inside of the switch will illuminate only when the flame sensor detects the burner flame. (**NOTE:** *The heater AUTO position is not used for continuous flow operation.*)

Load Auger Switch

This switch is used to select the operation of the wet fill conveyor. In both the AUTO and the MANUAL positions, the wet fill conveyor will operate if the dryer is low on grain and will automatically shut off when the dryer is full. In the AUTO position only, the dryer will automatically shut down should the dryer go low on grain. The time period between the dryer going low on grain and the actual shut down is determined by the setting on the out of grain timer. In the MANUAL position, the out of grain timer is deactivated. The MANUAL switch position should be used for initially filling the dryer. The AUTO switch position should be used during normal dryer operation. The switch will illuminate whenever the load auger is operating.

Unload Switch

The Unload switch turns the accutrol metering system and the unload auger ON or OFF and also selects the operation of the metering system. In the MANUAL position, the metering system operates at the speed set by the Metering Roll Speed Rotary switch. In the AUTO position, the metering system switches to a multi-speed operation controlled by the automatic moisture control. The switch will illuminate whenever the unload auger is operating.

Outside Light Switch

The service light is turned ON or OFF with this switch. In the AUTO position, the light is turned ON while the dryer is running automatically and turns OFF if a shut down occurs. In the ON position, the light is turned ON.

Start Switch

This switch starts and operates the dryer. If all of the above Dryer Operational switches are in the OFF position, each component can be turned ON by turning the Component switch to the ON position after the Run switch has been pressed. Or, if the Operational switches are preset to their ON position, the vision controls will sequentially start the various dryer components after the Run switch is pressed.

Stop Switch

This switch stops all dryer functions except the blower. If the Blower switch is in the ON position, the blower will continue to run for 15 minute. If you desire the blower to be OFF, simply turn the Blower switch to the OFF position. If an automatic dryer shut down occurs, first determine and correct the cause of the shut down. Then press the Dryer Power Stop button to reset the dryer before restarting.

Boot Screen

Turning the Power switch in the ON position, will start the Vision computer. The first screen to appear will be the Boot screen. (See Figure 6A.) Notice that there are four (4) “buttons” on the Boot screen. Install Dryer Software and Get Program From USB Flash buttons are only used for program updates that may be released at a later date. Touching the Start Dryer button will display the Default Operation screen. Touching the Exit To Windows button will close down the dryer program and take you to the Windows CE Operating System.

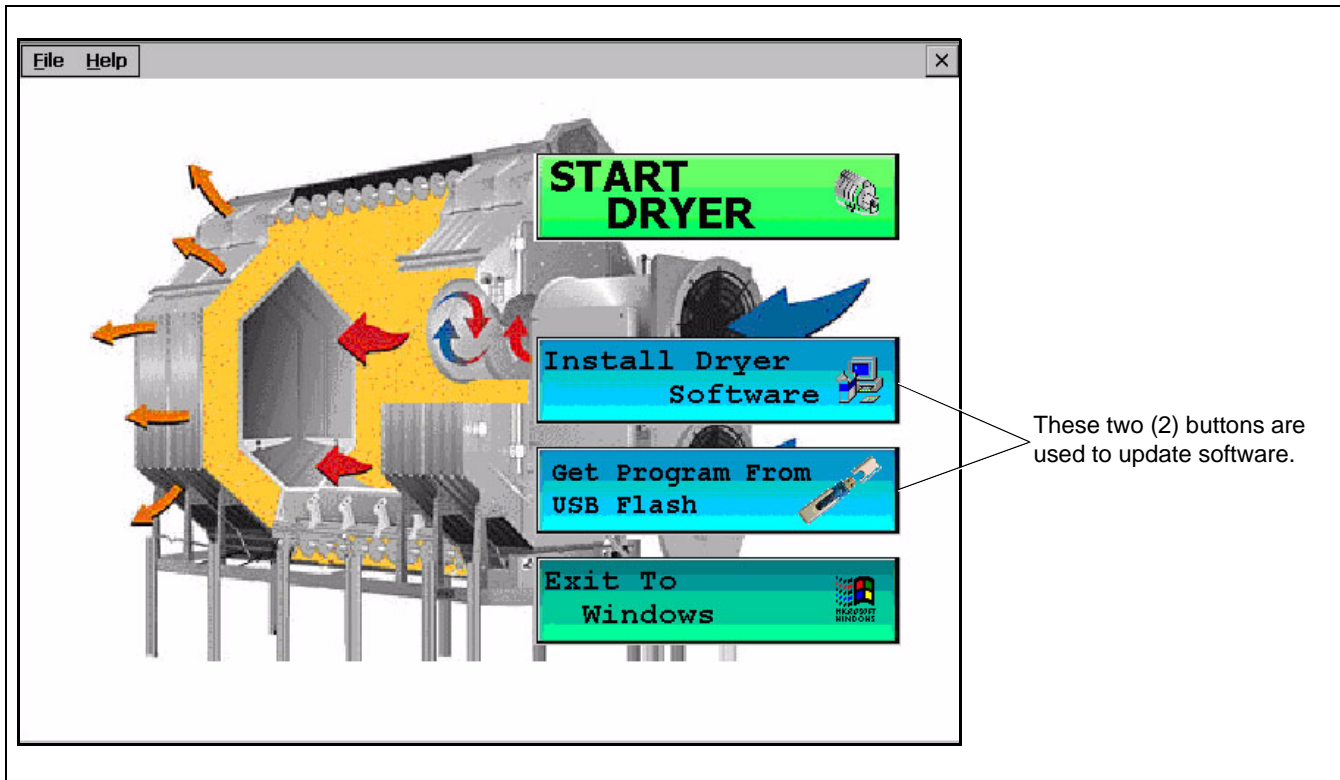

Figure 6A

Default Operation Screen

As you can see the Operation screen is divided into five (5) sections.

1. **Dryer operation animation:** Located on the left side of the Operation screen the operation animation shows the status of the fan/heaters, load and unload augers and meter rolls. It will also display the grain temperature, moisture content, M/C set point and bushel counter.
2. **Dryer status:** Located at the very top of the right side of the Operation screen the dryer status will tell you if the dryer is stopped, started, loading or unloading.
3. **Dryer status chart:** Located directly below dryer status chart. This chart will show the grain temperature, moisture in/out, temperature out and M.R.O. over a period of time.
4. **Plenum:** Located directly below dryer status chart. This chart will show the plenum temperature set point (SP), actual plenum temperature and burner status.
5. **Setup buttons:** Located across the bottom of the Operation screen. By touching these buttons the timers, temperature set points, dryer model and moisture control can be set up.

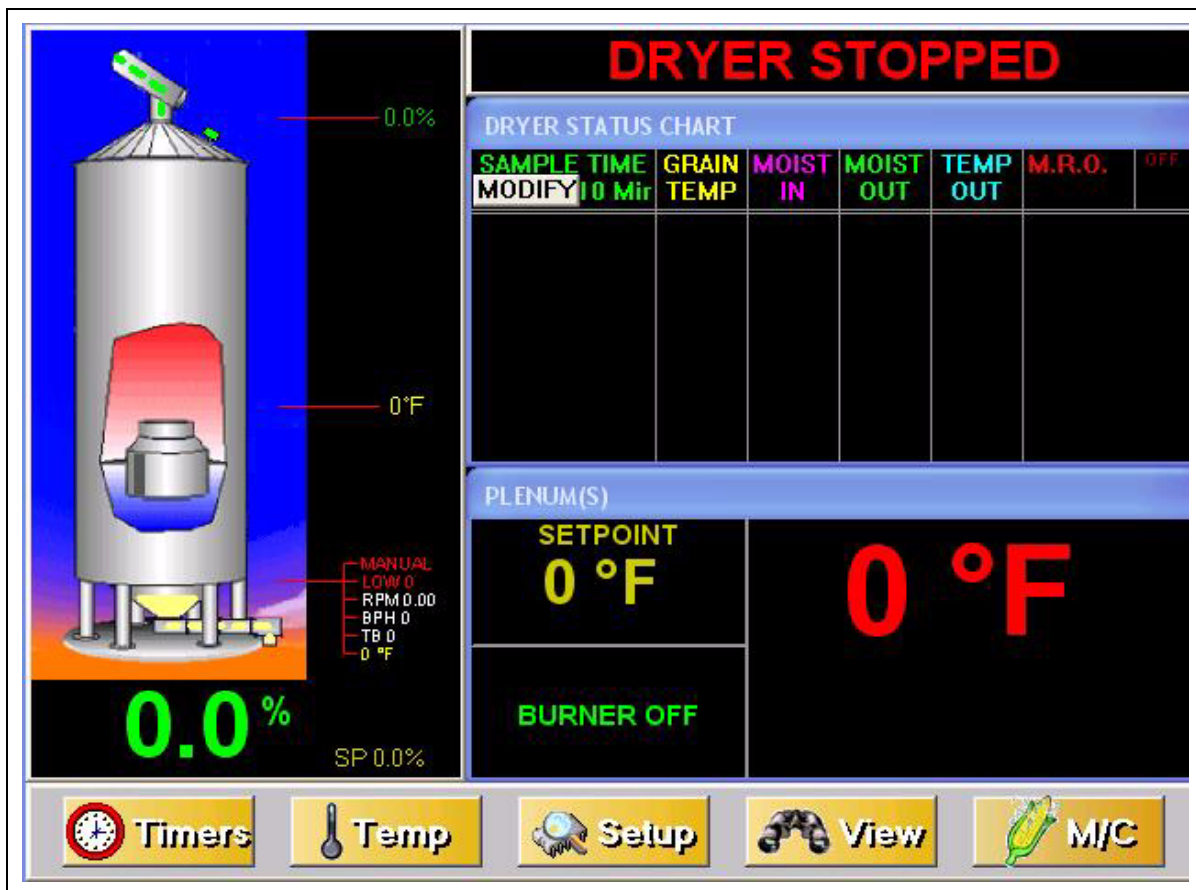



Figure 6B

Setting the Timers

Setting the timers for the dryer is a simple procedure. To set the timers, touch the  **Timers** button at the bottom of Operation screen. A new screen will appear called the Select Timers to Modify screen. (See Figure 6C on Page 26.) As you can see there are five (5) timers that you can modify:

- 1. Load delay:** This delay is used to delay the starting of the load conveyor when the dryer is unloading to prevent the load conveyor from cycling to often.
- 2. Out of grain (OOG) timer:** The OOG timer should be set to the maximum time it takes for the dryer to refill. Note that the computer will display the time required to fill the dryer on the previous load operation to aid you in setting an accurate time. If the dryer runs out of grain while the Load Auger switch is in the AUTO position, the OOG timer automatically shuts off the dryer after the period of time preset on the timer.
- 3. Fan delay timer:** The fan sequence delay timer.
- 4. Cool down timer:** The cool down timer is used to set the amount of time the fan is to run, after a non-heat related shut down. Setting to 0 will cause an immediate shut down on a warning. The range is from 0 to 20 minute.
- 5. Unload delay timer:** The unload delay timer is used to control the amount of time the unload auger runs after the metering system stops to allow the unload auger to clean itself out.

6. Vision Touch Screen Display

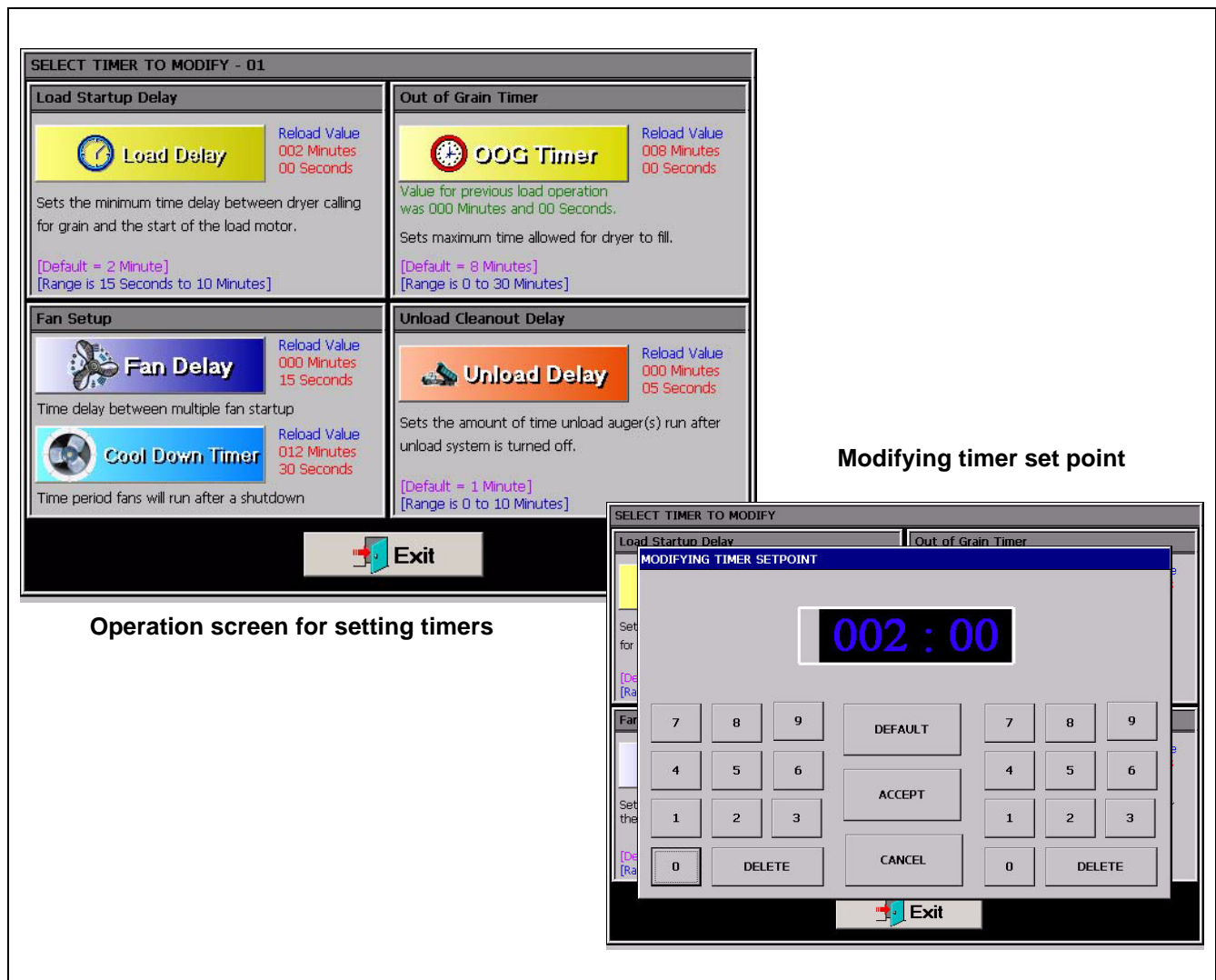

Figure 6C

To setup a timer touch the button of the timer you wish to modify. The Modify Timer Set Point screen will then be displayed. (See Figure 6C.) Note that there are two (2) number pads on this modify screen. The left number pad is used to modify the minutes and the right number pad will modify the seconds. Touching the Default button will automatically set the timer to the default set point for that timer. The Accept button will save the timer set point displayed in the time display. Touching Cancel will exit the Modify Timer Set Point screen without saving any changes and the timer will stay at the currently saved set point.

Once you have the timer set points set touching the Exit button at the bottom of the Modify Timer Set Point screen will return you to the Operation screen.

Setting the Temperatures

Setting the plenum temperature set point for the dryer is a simple procedure. To adjust the plenum temperature touch the **Temp** button at the bottom of Operation screen. A new screen will appear called the Select Temperature Set Point to Modify screen. (See Figure 6D on Page 27.)

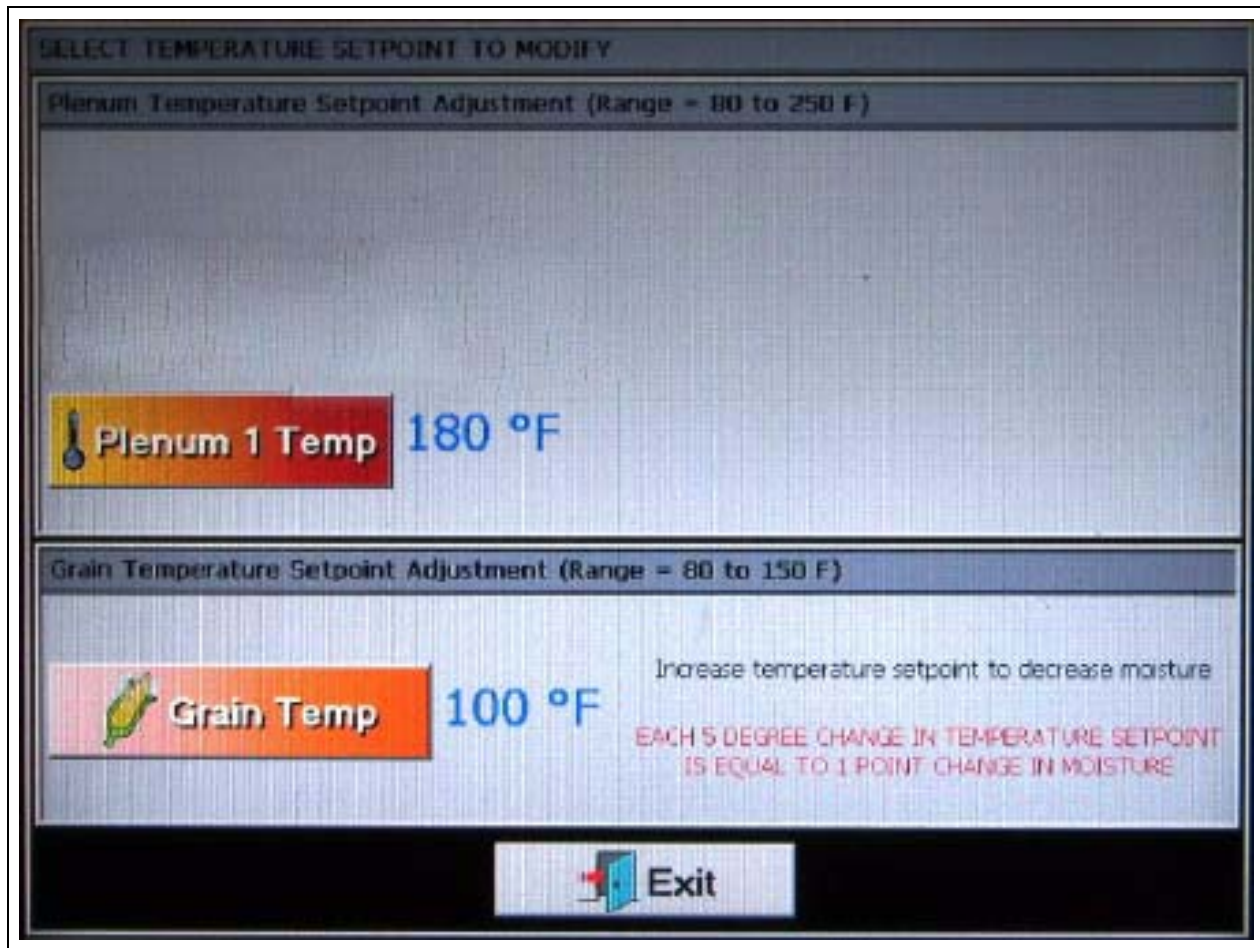



Figure 6D

The plenum temperature set point range is 80°F-250°F, and the current temperature set point for each plenum is displayed next to the corresponding Plenum button.

The grain temperature set point range is 80°F-150°F, and the current temperature set point for the grain temperature is displayed next to the Grain Temperature button. The grain temperature set point is used for the temperature based moisture control only.

Modifying a temperature set point is much like setting a timer described [on Page 25](#). Touch the desired button of the set point you wish to change. The Modify Temperature Set Point screen will appear. Enter the desired temperature using the displayed number pad then touch the Accept button. Touching the Exit button at the bottom of the Select Temperature Set Point to Modify screen will return you to the Operators screen.

The Setup Screen

The Setup screen will allow you to setup other parameters of the dryer. To use the Setup screen touch the  button. The Select Hardware Setup Parameter to Modify screen will now be displayed. As you can see there several different parameters that can be modified on this screen:

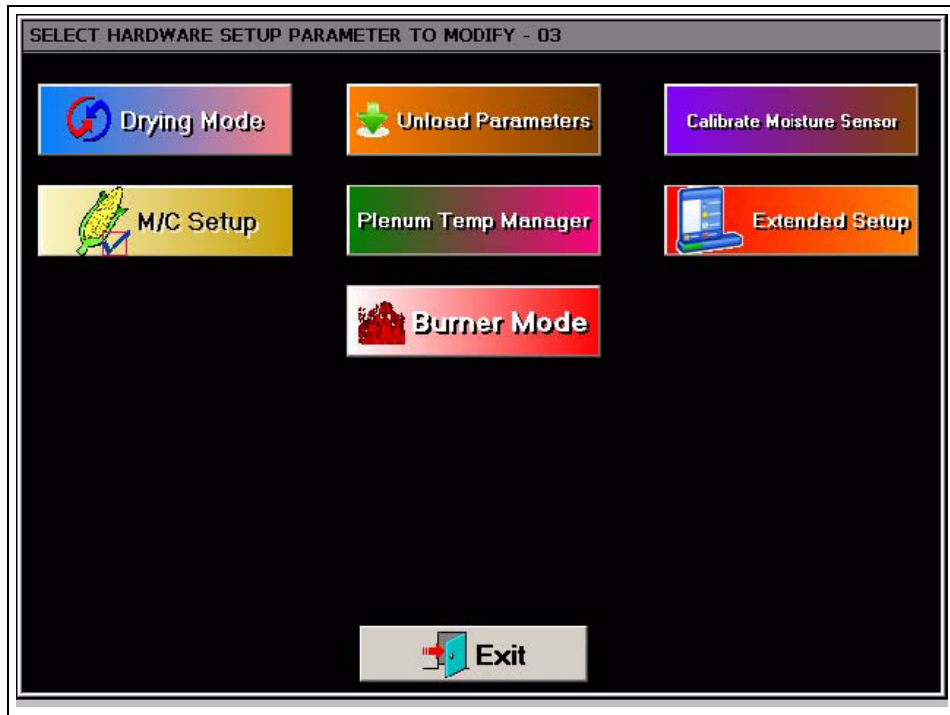

Figure 6E

1. **Drying mode:** Touching the Drying Mode button will display the select Drying Mode window. Continuous flow will be the only option for Tower Dryers.
2. **M/C setup:** The M/C Setup operations are described in greater detail in the dryer operation section [on Page 37](#) of this manual.
3. **Unload parameters:** Touching the Unload Parameters button will present a screen where you will edit you maximum and minimum unload rates.

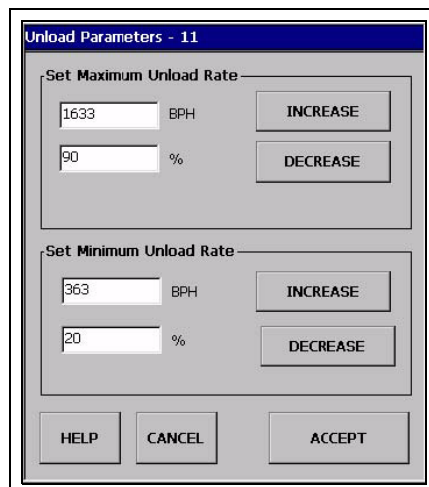

Figure 6F

4. **Plenum temperature manager:** The plenum temperature manager is used by the automatic moisture control to automatically lower drying temperatures if the maximum dryer unload rate is exceeded. Touching the Plenum Temperature Manager will display a Configuration screen that will allow you to turn this feature ON or OFF. Also, a configuration section is presented so that the user can edit the behavior of this option.

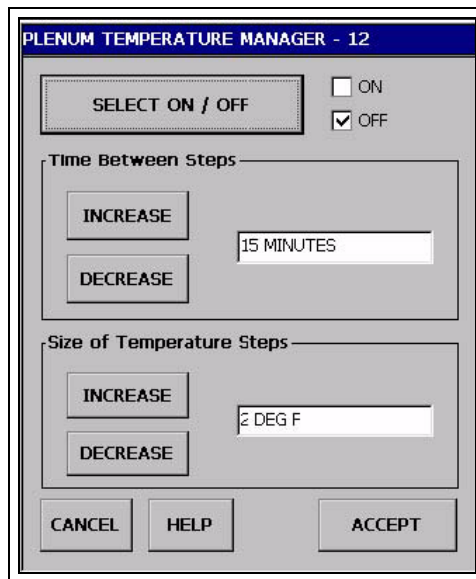

Figure 6G

5. **Burner mode:** Touching the Burner Mode button will display the Select Burner Mode screen. (See Figure 6H.) Tower dryer burner mode should always be set to ALL HIGH/LOW.

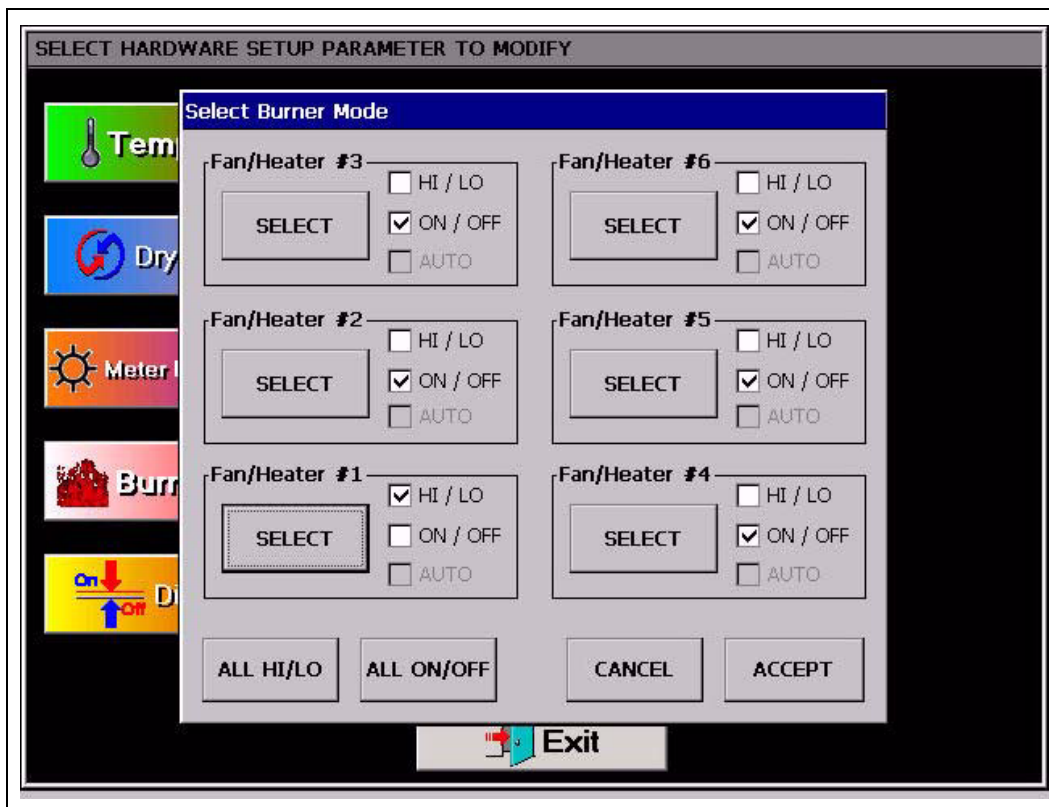

Figure 6H

6. Vision Touch Screen Display

6. **Calibrate moisture sensor:** Touching this button will display the Configuration screen to adjust the offset for wet and dry moisture and temperature.

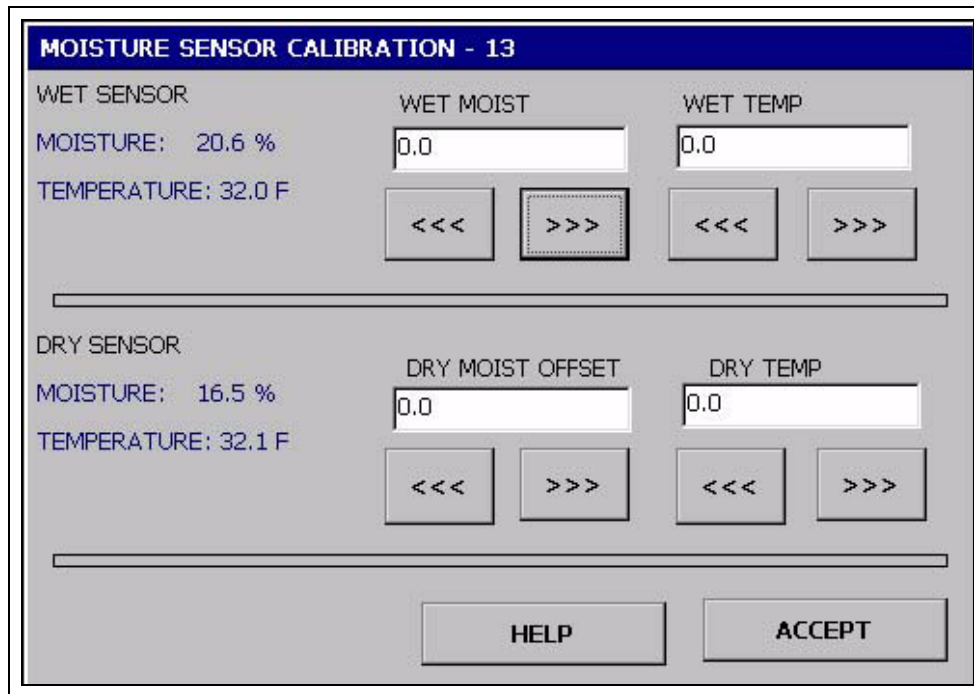

Figure 6I

7. **Extended setup:** Touching this button will display a setup menu with extended features and options.

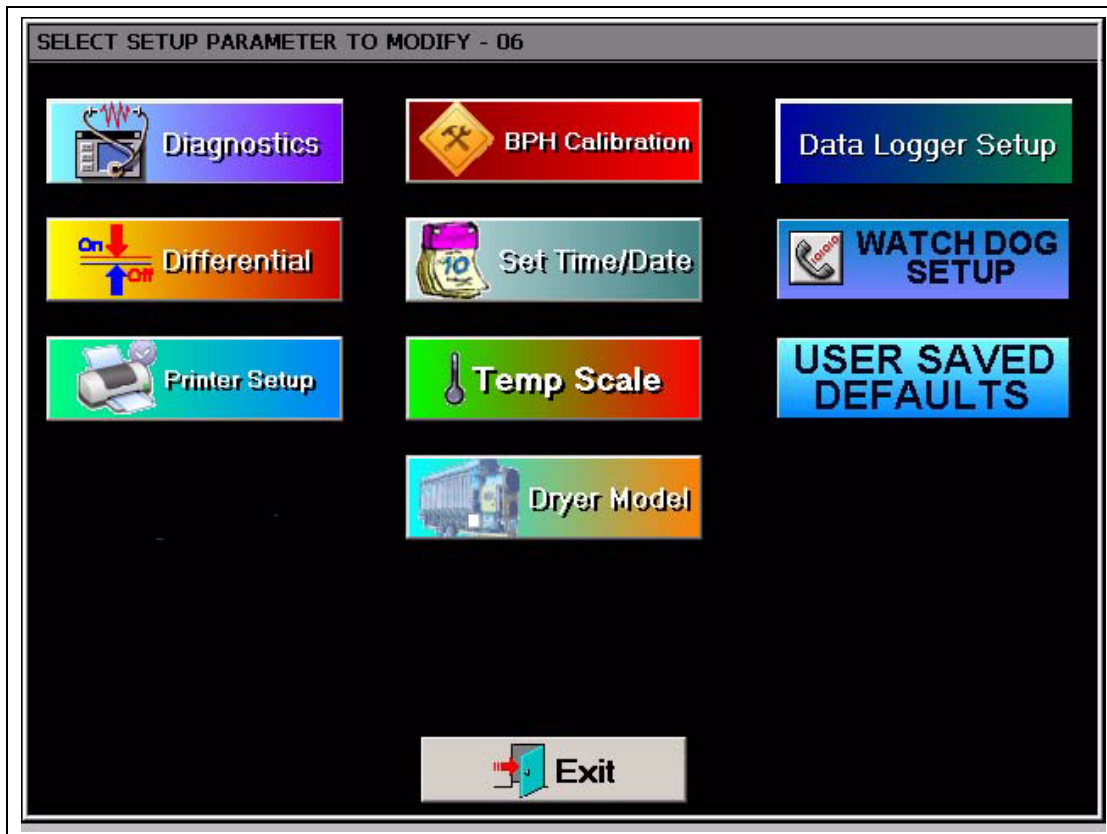

Figure 6J

1. **Diagnostics:** The Diagnostics operations are described in greater detail in the service section *on Page 49* of this manual.
2. **Differential:** Touching the Differential button will display the Modify Burner Differential Settings screen. (See *Figure 6K.*) Adjusting the burner differential settings allows the operator to keep the plenum temperature within a certain range. For example: If you have the temperature set point at 180° and you select $\pm 3^\circ$ as the burner differential, then the burner will switch to low heat at 183° and back to high heat at 177°. To modify a burner differential setting first touch the Plenum button you wish to modify, then select one of the five (5) differential setting button on the right side of the Modifying Burner Differential Settings screen. Touch the Accept/Exit button to save settings and return to the Select Hardware Setup Parameter to Modify screen. **NOTE:** *Tower dryer only have plenum #1.*

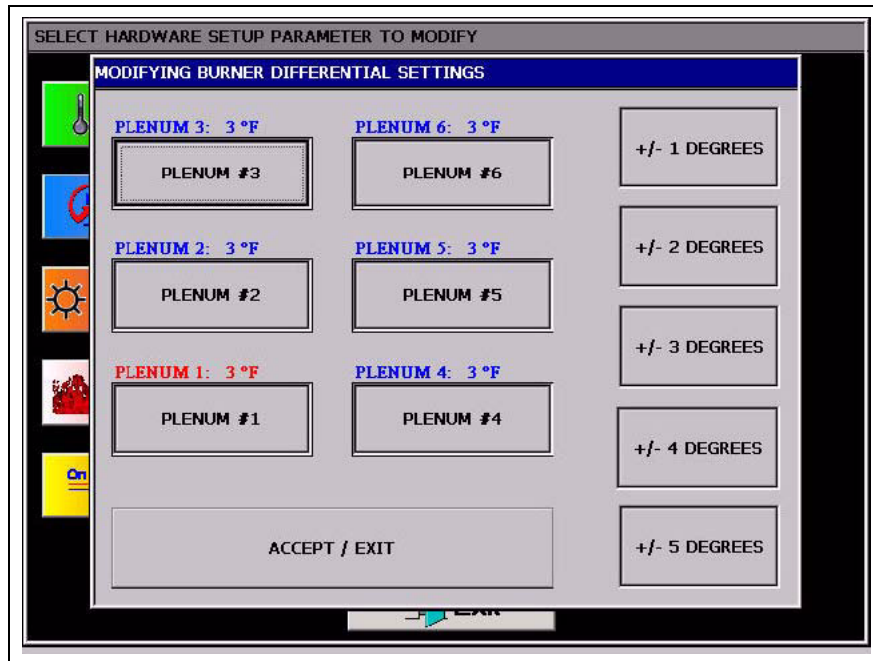

Figure 6K

3. **Printer setup:** This section only applies if the dryer is equipped with a printer.

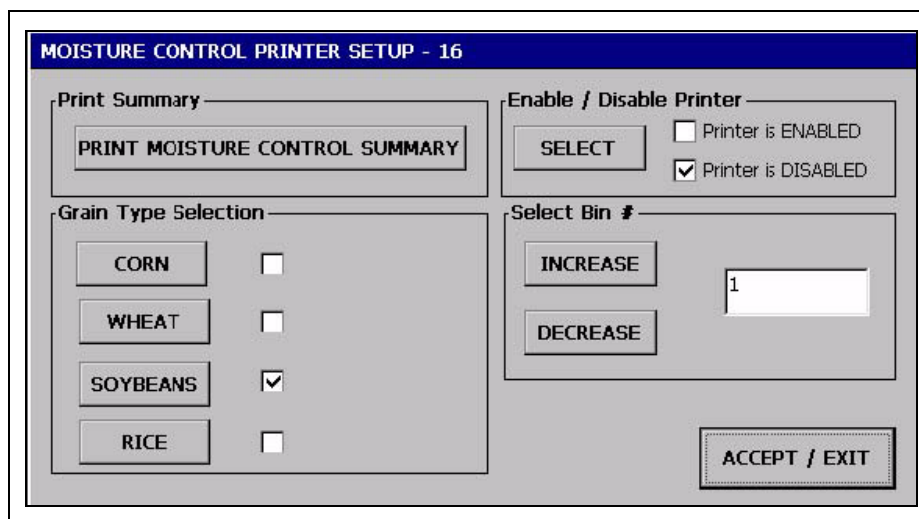

Figure 6L

6. Vision Touch Screen Display

- BPH calibration:** Touching the BPH Calibration button will display the Unload Bushels Setup screen. (See Figure 6M.) As you can see the bushel counter can be cleared by touching the Clear button. However if the bushel counter is out of calibration it can be calibrated by touching the Increase and Decrease buttons.

Example: If you ran 1000 bushels through the dryer but the bushel counter on the dryer reads 900 bushels then touch the Decrease button until the calibration reads 90%, or if you ran a 1000 bushels and the counter reads 1100 bushels then touch the Increase button until the calibration reads 110%.

When you are finished with the calibration or clearing the bushel counter touch the Accept button to return to the Hardware Setup Parameter screen.

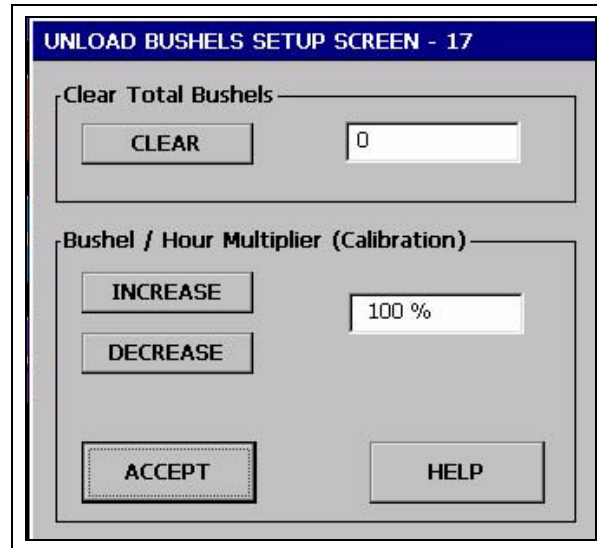

UNLOAD BUSHELS SETUP SCREEN - 17

Clear Total Bushels

CLEAR 0

Bushel / Hour Multiplier (Calibration)

INCREASE 100 %

DECREASE

ACCEPT HELP

Figure 6M

- Set Time/Date:** Touching the Set Time/Date button will display the Set Time/Date window. Use the Up and Down buttons to change each of the parameters for date and time. Touch Accept/Exit to save settings and return to the Select Hardware Parameter to Modify screen.

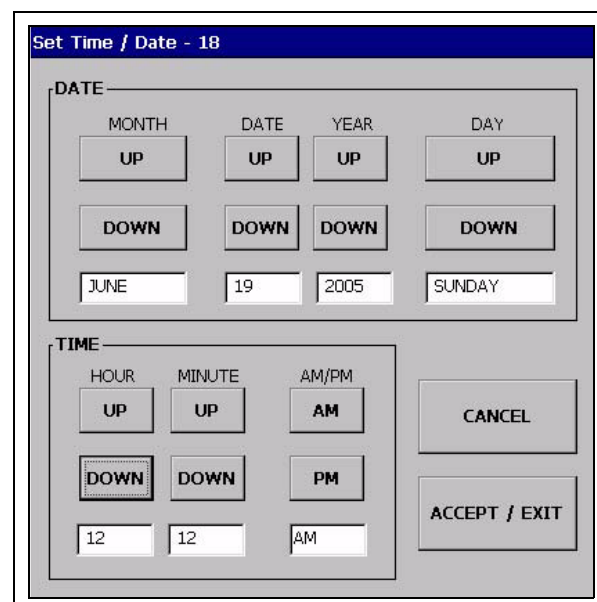

Set Time / Date - 18

DATE

MONTH DATE YEAR DAY

UP UP UP UP

DOWN DOWN DOWN DOWN

JUNE 19 2005 SUNDAY

TIME

HOUR MINUTE AM/PM

UP UP AM

DOWN DOWN PM

12 12 AM

CANCEL

ACCEPT / EXIT

Figure 6N

- Temp scale:** Touch the Temp Scale button to choose either English units or SI units temperature scales. Depending what temperature scale you now operating in touching this button will display a Pop-up window asking if you want to switch to SI (celsius, metric tons, etc.,) or English units (fahrenheit, bushels, etc.).
- Dryer model:** Touching the Dryer Model button will display the Dryer Hardware Setup window. In order for the dryer operate properly the following items must be entered correctly: model number and fuel type. Touch the select button until a check mark appears next to the parameter corresponding to the dryer model.

The screenshot shows a touch screen interface titled "DRYER HARDWARE SETUP". It contains two main sections for configuration:

- Fuel:** A list of fuel types with checkboxes: Diesel, Vapor, Natural Gas, and LP. The LP option is selected with a checkmark. A "SELECT" button is located below this list.
- Model Number:** A list of model numbers with checkboxes: 1008, 1010, 1012, 1015, 1050, 1260, 1575, and 1875. The 1015 option is selected with a checkmark. A "SELECT" button is located below this list.

At the bottom right of the screen is a large "ACCEPT/EXIT" button.

Figure 60

- Data logger setup:** Touching this button will display a dialogue box which will allow you to turn this option ON. Also, you will have the option to delete the log file or copy it to a USB thumb drive.
- User saved defaults:** Pressing this button will prompt you to save the current dryer settings as the default settings for the system.

Dryer Checks

This section gives a series of checks to be carried out on the dryer before starting for the first time in the drying season. If any of the checks fail to produce the stated result, you should consult your dealer.

You should not attempt to use the dryer unless all the pre-start checks have been successfully completed.



Before attempting to operate the dryer make sure all safety shields are in place, all access doors are closed and all personnel are clear of the dryer.

Inspect the Accutrol Metering System

Open the four (4) access doors and inspect the accutrol sweep metering system to ensure that the system is free of foreign material.

Electrical Power

Turn ON the electrical power supply to the dryer, set all circuit breakers to ON, including the safety disconnect handle mounted on front of the dryer power panel.

Control Power Switch

Turn the Control Power switch to ON. At this point the controller will lock out all other dryer functions. Once the Boot screen appears ([See Page 24](#)), touch the Start Dryer button and the dryer will perform a safety circuit check. If a fault is found, the cause will be displayed on the Main screen. If all are found safe, the Start switch will illuminate, indicating that the dryer is ready to be started.

Start Switch

Push the Dryer Start switch, and all the selector switches on the control panel will be activated.

Fuel Check

If using LP gas, make sure the tank has plenty of fuel and that the tank **does not** have a regulator mounted on the liquid line. Slowly open the main fuel supply valve at the tank. Then, open the manual shut off valve on the dryer to allow fuel flow to the dryer.

If using natural gas, make sure an adequate supply at 10 PSI of pressure is available. Turn ON the valve along the supply line. Inspect all gas lines and connections for possible leaks.



Any gas leaks must be fixed immediately.

Load Auger

With the grain supply shut off, quickly bump the Load Auger switch to manual, and check all filling equipment for proper rotation.

Turn the Load Auger switch to the AUTO position. The filling equipment should run for eight (8) minutes (the default out of grain setting) and then the dryer will shut down leaving the safety shut down message (out of grain warning) displayed. Press the Dryer Power Stop button to reset the panel, then press the Start button.

Unload Auto Operation

To check auto operation place the Unload switch in the AUTO setting. Check unload equipment for proper rotation.

Unload Manual Operation

To check manual operation move the Unload switch to the MANUAL position. Check unload equipment for proper rotation.

Accutrol Sweep Metering System Operation

To check the metering operation turn the knob clockwise, and the metering speed should increase. The metering system should be turning clockwise when viewed from above. Turning the knob counterclockwise will decrease the speed. When the meter system is set to maximum (1000) the meter roll speed should be 2.6 RPM. Turn the Unload switch OFF after these checks are complete. The adjustable dry grain auger will continue to run for 60 second (default clean out delay setting) after the switch is turned OFF to allow for clean out.

Fan Switch

Momentarily turn the Fan switch to ON and observe the fan for rotation.

Burner Safety

To check the burner safety function, first make sure the main gas valve is OFF. Turn the Fan switch ON and allow the fan to start. Then, turn the Heater switch ON. The dryer will go through a 15 second purge time followed by a 10 second ignition time. The dryer will then shut down. The safety message, "Ignition Failure Fan #" will appear.

Burner Test Fire

Test fire the burner by starting the fan. Adjust the plenum temperature set point to 140°F (60°C). On LP fired dryers, open the liquid shut off valve and the manual shut off valve. On NG fired dryers, open the manual shut off valve. Turn the Burner switch to the ON position. After a 30 second purge time, the main, blocking and bypass solenoid shut off valves (and the liquid solenoid valve on LP fired dryers) will open and the burner will illuminate. The Burner switch should be illuminated and the plenum temperature will start to increase. On LP fired dryers, adjust the gas pressure regulator so that the inlet pressure on the fuel train is at approximately 7-9 PSI. On NG fired dryers, the manual shut off valve should be used to adjust the inlet pressure to 7-10 PSI of pressure. *(See Figure 7A and Figure 7B on Page 36.)* When the plenum temperature reaches the set point, the bypass solenoid will close. Adjust the bypass solenoid adjustment screw so that the burner pressure gauge reads approximately 8-12 ounces of pressure on Low-Fire. Turning the adjustment screw clockwise decreases the burner pressure when the bypass solenoid is closed. The computer should cycle the burner between High-Fire and Low-Fire 4 to 5 times a minute. If, during normal operation, the burner continuously remains on High-Fire or does not get to operating temperature, slightly open the manual shut off valve on NG dryers or slightly increase the regulator pressure on LP dryers. If the burner stays on Low-Fire and does not cycle, slightly close the bypass solenoid by turning the adjusting screw clockwise.

7. Test Firing

Dryer Shut Down

To shut down the dryer,

1. Close the fuel supply valve at the tank or valve along the fuel line.
2. If the burner is operating, let the dryer run out of fuel, and it will shut down automatically due to loss of flame.
3. Close the fuel valve at the dryer, and press the Dryer Power Stop button.
4. Turn OFF the control power.
5. Turn OFF the safety disconnect handle on the front of the power box, and turn OFF the main power to the dryer.

Emergency

In case of emergency push the Dryer Stop button or the Emergency Stop button. This will interrupt power to the control panel and the fan, burner and all augers will stop immediately.

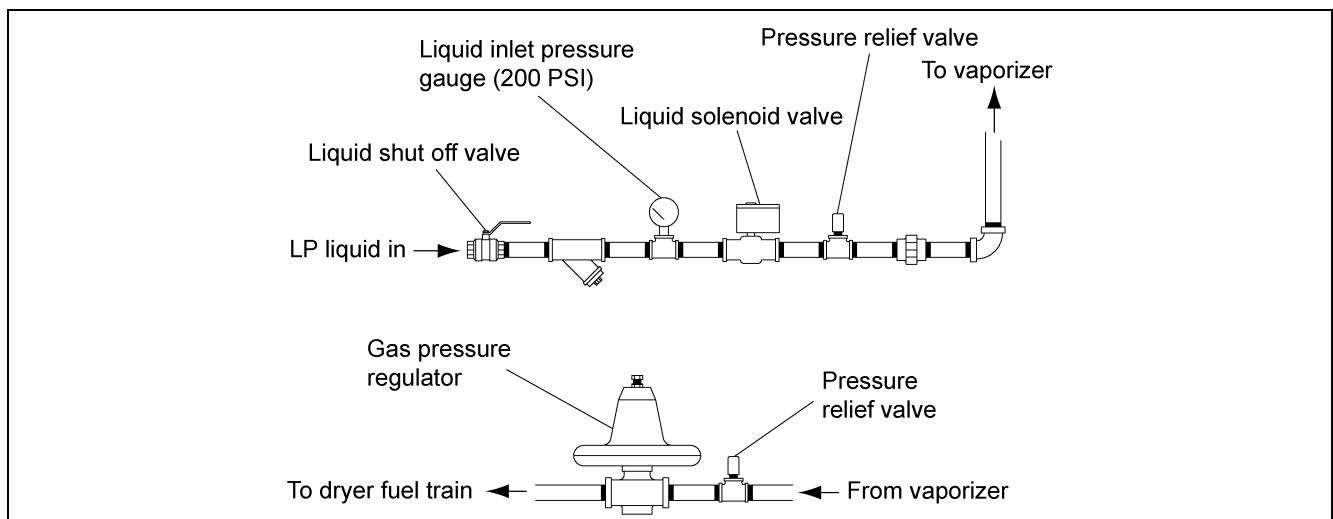

Figure 7A Vapor Fuel Train

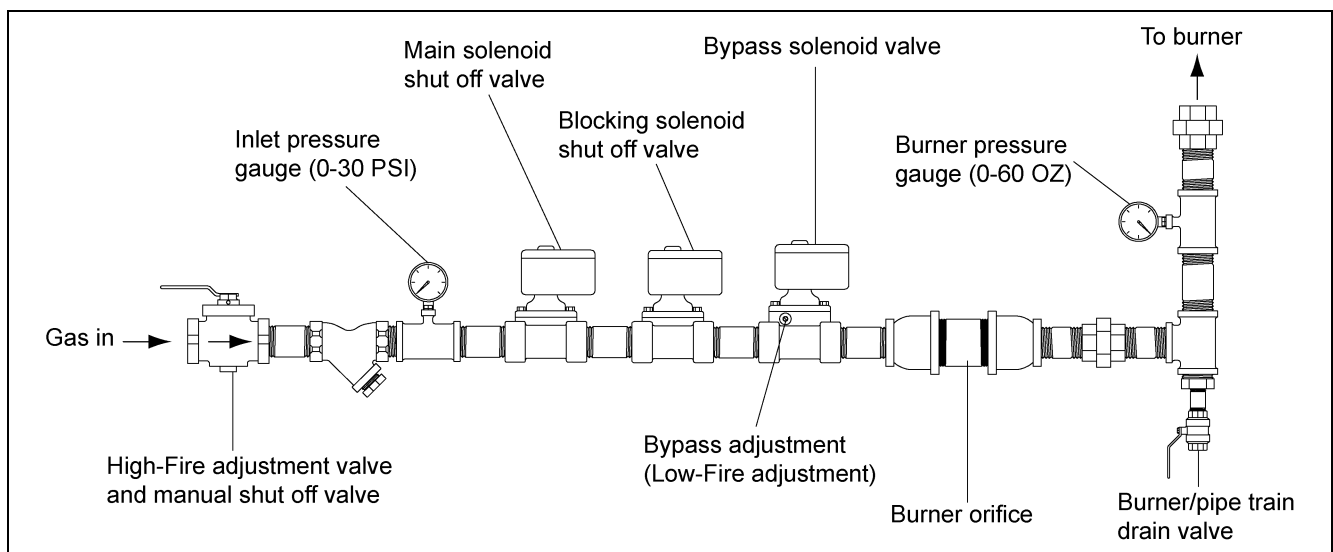

Figure 7B Modulator Fuel Train

Dryer Start-up

1. Before attempting to operate the dryer, make sure all safety shields are in place, the burner is uncovered, all column clean-out doors are closed, the four (4) metering access doors are closed, the drain valve in the fuel train is closed and all personnel are clear of the dryer and grain handling machinery.
2. Turn all selector switches on the control panel to the OFF position.
3. Turn ON the electrical power supply to the dryer and move the dryer's main breaker disconnect handle mounted on the dryer's power box to the ON position.
4. Turn the Control Power switch located on the control panel to the ON position. The switch will illuminate. At this point, the controller will lock out all other dryer functions. Once the Boot screen appears, touch the Start Dryer button. The dryer will perform a safety circuit check. If no faults are found, the dryer is ready to be started.
5. Move the Load Auger switch to the MANUAL and push the Dryer Start switch. The load auger will immediately start and the Load Auger switch will illuminate. If additional loading equipment is wired to the dryer it will also start-up.
6. When the dryer is full of grain the load auger will stop automatically and any auxiliary loading equipment wired to the dryer will also stop.
7. Move the Load Auger switch to the AUTO position to activate the out of grain timer. (See [Page 25](#) for adjusting the out of grain timer.)
8. Open the main fuel valve on the propane tank or the natural gas fuel supply line. Open all manual fuel shut off valves on the dryer.
9. Turn the Fan switch to the ON position. The fan will start and the light in the switch will illuminate when air pressure in the dryer is detected.
10. Turn the Heater switch to the ON position. After a purge period of approximately 30 seconds, the burner will fire and the Heater switch will illuminate when the flame sensing circuit is sensing flame. For initial burner testing set the plenum temperature to 140°F using the "setting temperatures" procedure found [on Page 26](#). For normal drying operations, use the following guidelines for setting the drying temperature:
 - a. Shelled corn (20% to 30%) --- 210°F to 220°F.
 - b. Shelled corn (15% to 20%) --- 180°F to 200°F
 - c. Small grains (wheat, oats, barley or milo) --- 150°F
 - d. Soybeans -- 130°F.
 - e. **NOTE:** *As a general rule for obtaining the highest drying efficiency, use the highest drying temperature which will not adversely affect grain quality.*

Set the drying temperature to the desired level.
11. Look in the reference setting tables [on Pages 43-48](#) and select the appropriate table for the dryer and grain moisture levels. Turn the Unload Auger switch to MANUAL position. The unload auger and metering system will start discharging grain from the dryer. Push the Metering Roll Speed switch and turn the knob to adjust the speed to that suggested in the setting tables. (**NOTE:** *Make sure to press the "Accept/Exit" button on the Metering Roll screen when changing metering roll speed to lock in the new speed.*) ([See Figure 8A on Page 38.](#))

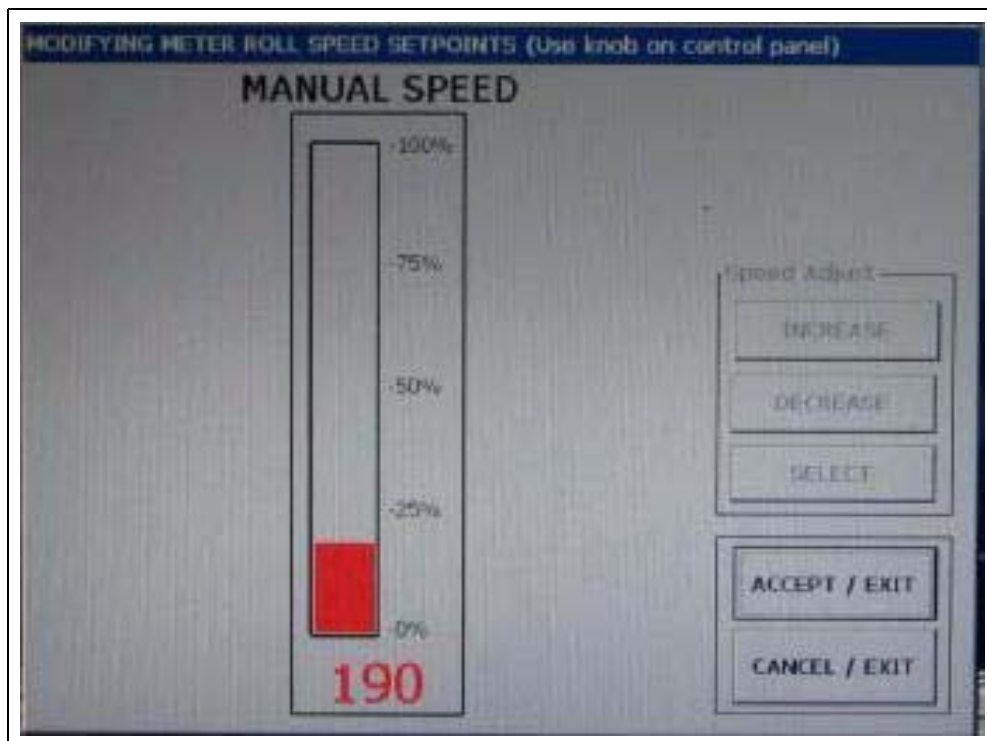

Figure 8A

12. It is important to remember that adjustments in the metering roll speed takes 1-2 hours for the full impact of the adjustment to be realized on exiting grain moisture levels. Continue to operate the dryer's metering speed manually making small hourly changes either up or down to adjust for the desired final moisture content.
13. The metering system can be operated either manually or can be operated in the automatic mode with the dryer automatically speeding up and slowing the metering system to maintain the desired grain moisture output. For automatic operation, see moisture control setup section [on Page 39](#).

Dryer Shut Down

1. To turn the dryer off at the end of the day, turn the Heater switch OFF, the Load Auger switch OFF and the Unload Auger switch OFF.
2. Continue to let the fan operate for approximately 15 minutes to cool the warm grain in the dryer down. Should the dryer shut off by itself due to an out of grain or loss of flame warning, the fan will continue to operate for the time set on the cool down timer [on Page 25](#). Pushing the control panel Off button will also automatically shut the fan OFF after the cool down timer setting. The fan can be stopped immediately by turning the Fan switch to the OFF position.
3. Turn the Control Power switch OFF.
4. Shut all gas valves.
5. Move the dryer's main breaker disconnect handle mounted on the dryer's power box to the OFF position.

Moisture Control Setup

1. To setup the moisture control, first press the Setup button on the dryer touch screen. (See Figure 8B.)

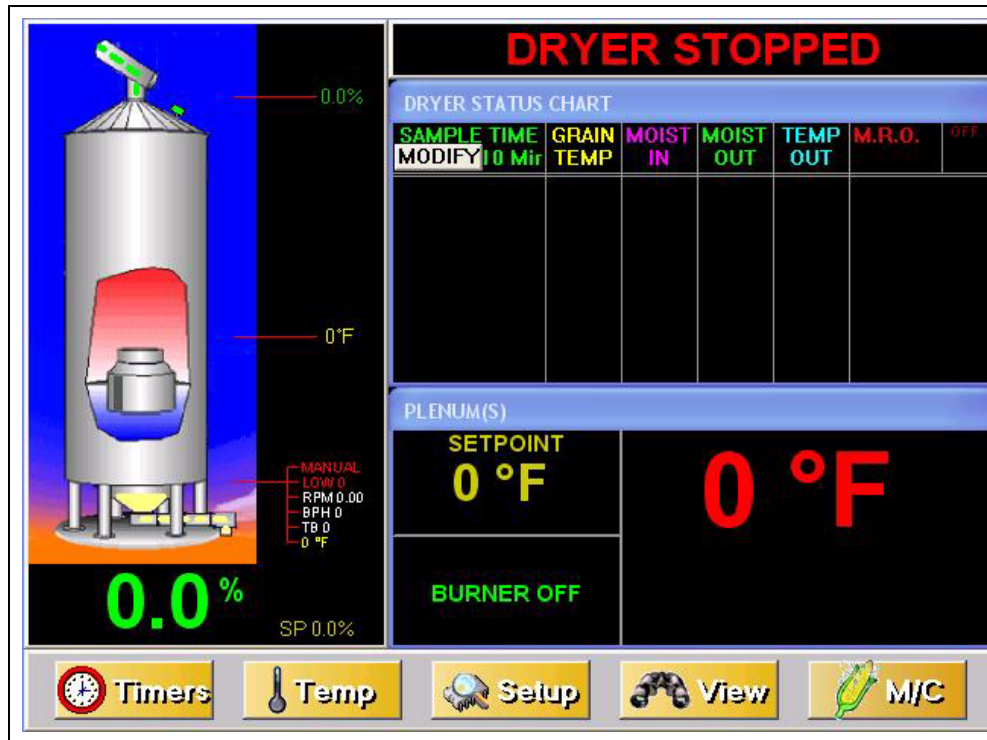

Figure 8B

2. Press the M/C Setup button on the Setup screen. (See Figure 8C.) A screen entitled Continuous Flow Setup will appear. (See Figure 8D on Page 40.)

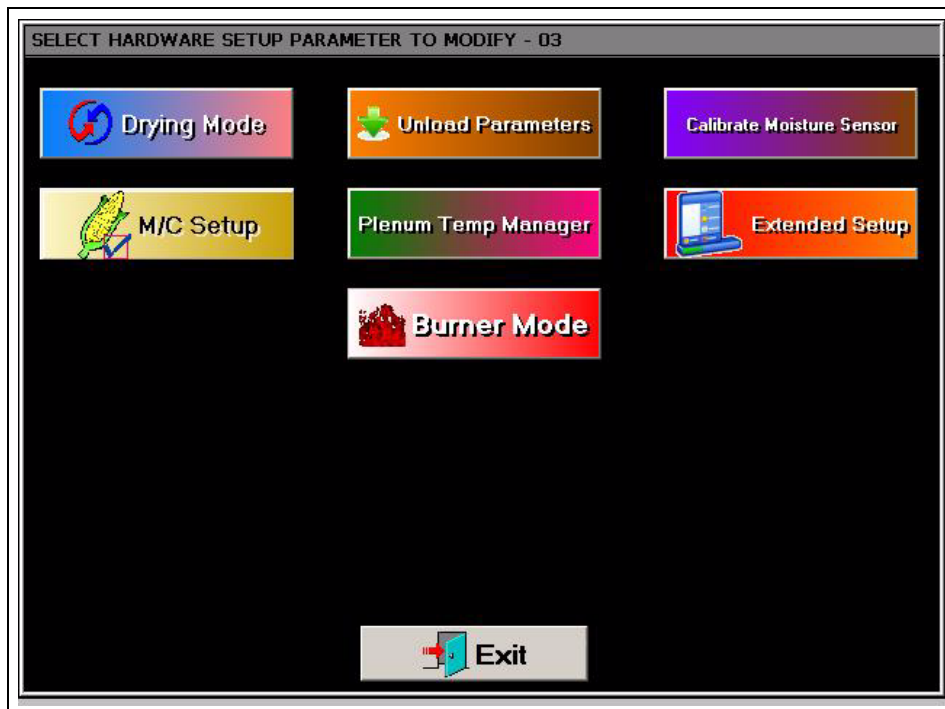

Figure 8C

8. Dryer Operation

- The dryer can be operated using a grain temperature only based moisture control or a moisture based control utilizing the moisture sensors on the dryer. Most operators choose to operate the dryer using the moisture based moisture controller. To set the moisture controller to the moisture based system, press the Moisture button. (See Figure 8D.) The Moisture box should have a check mark.
- Two (2) options exist for the moisture based moisture control, either “Variable” or “5 Speed”. In the “Variable” mode the unload rate of the dryer will continuously vary to maintain the desired final moisture levels. In the “5 Speed” mode, the unload rate will make stepped changes in speed to maintain the desired final moisture. The “Variable” option works best if the incoming moisture to the dryer is fairly consistent. The “5 Speed” option works best for changing incoming moisture levels. To activate either, press the appropriate button under the Moisture Based Options portion of the window shown in Figure 8D.

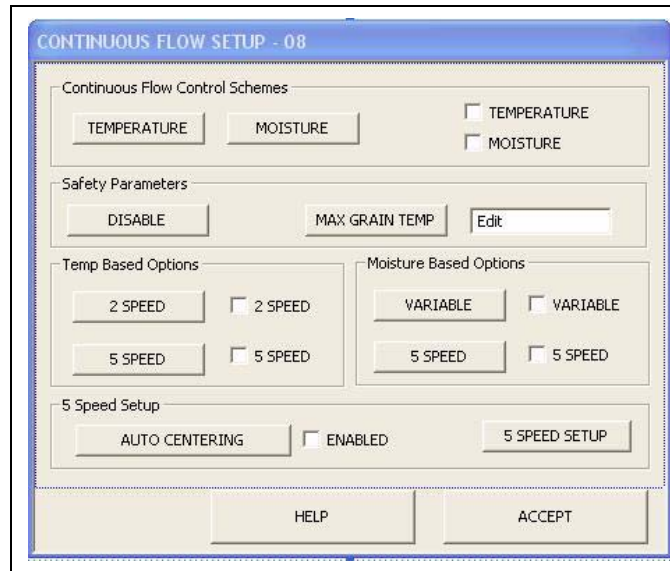

Figure 8D

- Once the appropriate moisture controller option is selected, the dryer unload rate can be automatically controlled by first selecting the desired final moisture content of the grain exiting the dryer. Press the M/C button on the bottom right hand corner of the main dryer screen. (See Figure 8B on Page 39.) Enter the final desired moisture content. (See Figure 8E.) To activate the automatic moisture control, turn the Unload Auger switch to the AUTO position. **NOTE:** To avoid wide swings in outgoing moisture levels on initial cold dryer start-ups, it is best to operate the unload system manually until the dryer and grain within the dryer is warmed up.

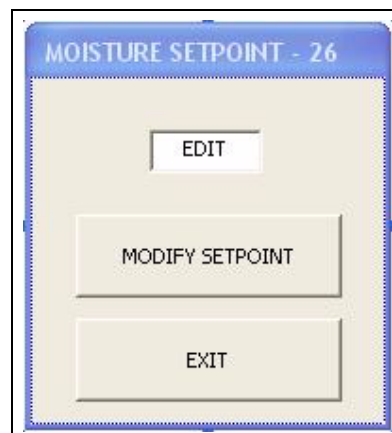

Figure 8E

6. The centering point about which the unload rate will vary, is determined by the manual unload rate at the time that the dryer is placed into automatic operation. When using the “5 Speed” option, the dryer will automatically adjust this centering point throughout the day if the Auto Centering button is pressed on the Continuous Flow Setup screen. (See [Figure 8D on Page 40.](#)) It is helpful when restarting a dryer after a lengthy drying run to set the manual unload rate to the same rate as the last operating unload rate reading indicated on the dryer status chart under the MRO column. (See [Figure 8B on Page 39.](#)) Operating the dryer in the manual mode until it is warmed up at this unload rate before switching the Auger Unload switch to AUTO in either the “Variable” or “5 Speed” mode will ensure a more accurate dryer unload control.
7. The parameters for “5 Speed operation” are preset for typical dryer operation. They can be modified if desired by pressing 5 Speed Setup. (See [Figure 8D on Page 40.](#)) Changes to the parameters can be made in the resulting screen that appears. (See [Figure 8F.](#))

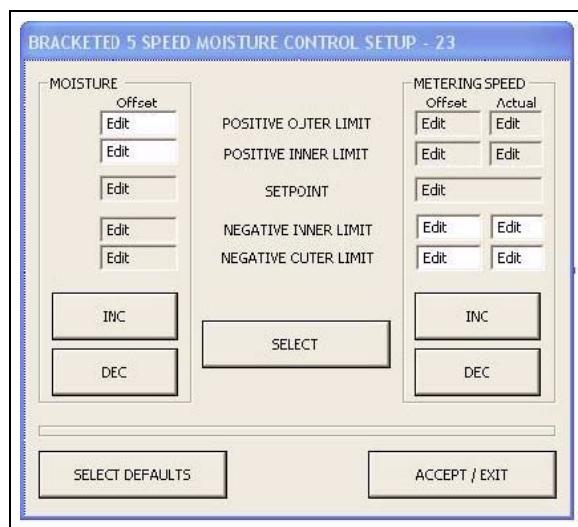

Figure 8F

8. For accurate moisture control, it is important that the moisture sensors on the dryer be calibrated. It is recommended that the dry sensor be calibrated daily. To calibrate the moisture sensors, press the Calibrate Moisture Sensor button on the Setup screen. (See [Figure 8C on Page 39.](#)) The following screen will appear. (See [Figure 8G.](#)) To calibrate, compare a moisture sample on a moisture tester to the dryer’s moisture reading. If for example, the tester gives a reading of 15.7% and the dryer’s dry sensor reads 14% enter a dry moisture offset of +1.7% so that the dryer reading will compare with the moisture tester reading.

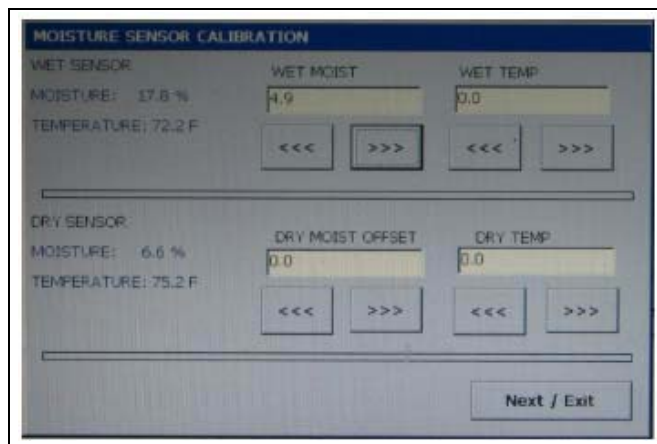
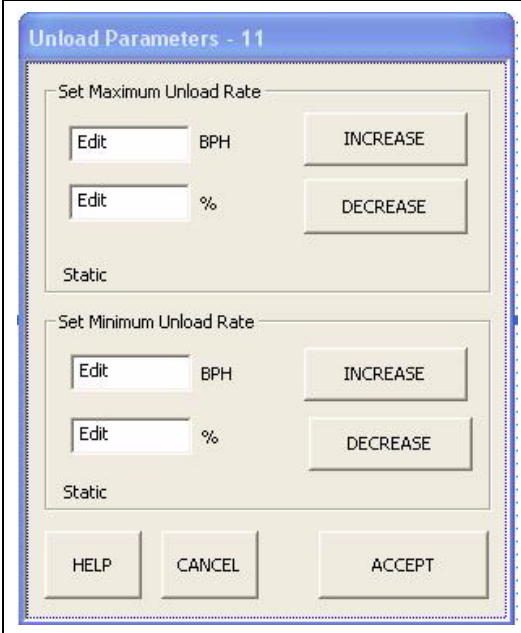

Figure 8G

8. Dryer Operation

9. To avoid overloading dry conveyors taking grain away from the dryer when the dryer unload is operating in the automatic mode, it may be necessary to limit the maximum and minimum unload rate on the dryer's metering system. To accomplish this, press the Unload Parameters button on the Setup screen. (See Figure 8C on Page 39.) The following screen will appear. (See Figure 8H.) Set the appropriate limits if necessary.



The screenshot displays a software interface titled "Unload Parameters - 11". It is divided into two main sections: "Set Maximum Unload Rate" and "Set Minimum Unload Rate". Each section contains two input fields: one labeled "Edit" followed by "BPH" and another labeled "Edit" followed by "%". To the right of each "BPH" field is an "INCREASE" button, and to the right of each "%" field is a "DECREASE" button. Below the input fields in each section is a "Static" label. At the bottom of the screen are three buttons: "HELP", "CANCEL", and "ACCEPT".

Figure 8H

Drying Time Table.....Model 1008

Reference Setting Table for Corn -- Model 1008

Moisture		Divider Set for Maximum Heat Area			Divider Set for Minimum Heat Area		
		170°F % Unload Rate	190°F % Unload Rate	210°F % Unload Rate	170°F % Unload Rate	190°F % Unload Rate	210°F % Unload Rate
In	Out						
17%	15%	510	600	700	500	590	670
18%	15%	380	460	520	380	440	510
19%	15%	310	370	430	310	360	410
20%	15%	270	320	360	260	310	350
21%	15%	230	270	330	230	270	300
22%	15%	200	240	280	200	230	270
23%	15%	180	210	250	180	210	240
24%	15%	160	190	220	160	190	210
25%	15%	140	170	200	140	170	190
26%	15%	130	150	180	130	150	170
27%	15%	120	140	160	110	130	150
28%	15%	100	120	140	100	120	140
29%	15%	90	110	130	90	110	120
30%	15%	90	100	120	80	100	110
32%	15%	70	80	100	70	80	90
35%	15%	60	70	80	60	60	70

Reference Setting Table for Wheat, Barley, Milo -- Model 1008

Moisture		Divider Set for Maximum Heat Area			Divider Set for Minimum Heat Area		
		140°F % Unload Rate	150°F % Unload Rate	160°F % Unload Rate	140°F % Unload Rate	150°F % Unload Rate	160°F % Unload Rate
In	Out						
15%	13%	440	490	540	400	440	490
16%	13%	330	370	410	300	340	370
17%	13%	270	300	330	250	270	300
18%	13%	230	260	280	210	230	260
19%	13%	200	220	250	180	200	220
20%	13%	180	200	180	160	180	200
21%	13%	160	170	190	140	160	170
23%	13%	130	140	150	130	130	140
25%	13%	100	110	120	90	100	110

9. Drying Time Tables

Reference Setting Table for Soybeans -- Model 1008

Moisture		Divider Set for Maximum Heat Area			Divider Set for Minimum Heat Area		
		120°F % Unload Rate	130°F % Unload Rate	140°F % Unload Rate	120°F % Unload Rate	130°F % Unload Rate	140°F % Unload Rate
In	Out						
15%	13%	490	510	580	400	460	520
16%	13%	330	380	430	300	340	390
17%	13%	270	310	350	240	280	310
18%	13%	230	260	300	210	240	270
19%	13%	200	230	260	180	210	230
20%	13%	180	200	230	160	180	210
21%	13%	160	180	200	140	160	180
23%	13%	130	140	160	110	130	150
25%	13%	100	120	130	90	100	120

Drying Time Table.....Model 1010

Reference Setting Table for Corn -- Model 1010

Moisture		Divider Set for Maximum Heat Area			Divider Set for Minimum Heat Area		
		170°F % Unload Rate	190°F % Unload Rate	210°F % Unload Rate	170°F % Unload Rate	190°F % Unload Rate	210°F % Unload Rate
In	Out						
17%	15%	680	800	930	650	760	870
18%	15%	510	610	700	490	570	650
19%	15%	420	490	570	400	460	530
20%	15%	350	420	480	340	400	450
21%	15%	310	360	440	290	340	390
22%	15%	270	320	370	260	300	350
23%	15%	240	280	330	230	270	310
24%	15%	220	250	290	210	240	270
25%	15%	190	230	260	180	210	240
26%	15%	170	200	240	160	190	220
27%	15%	150	180	210	150	170	200
28%	15%	140	160	190	130	160	180
29%	15%	130	150	170	120	140	160
30%	15%	110	130	160	110	130	150
32%	15%	100	110	130	90	110	120
35%	15%	80	90	100	70	80	100

Reference Setting Table for Wheat, Barley, Milo -- Model 1010

Moisture		Divider Set for Maximum Heat Area			Divider Set for Minimum Heat Area		
		140°F % Unload Rate	150°F % Unload Rate	160°F % Unload Rate	140°F % Unload Rate	150°F % Unload Rate	160°F % Unload Rate
In	Out						
15%	13%	550	610	680	510	570	630
16%	13%	420	460	510	390	430	470
17%	13%	340	380	420	310	350	380
18%	13%	290	320	350	270	300	330
19%	13%	250	280	310	230	260	280
20%	13%	220	250	230	200	230	250
21%	13%	200	220	240	180	200	220
23%	13%	160	170	190	160	160	180
25%	13%	130	140	150	120	130	140

Reference Setting Table for Soybeans -- Model 1010

Moisture		Divider Set for Maximum Heat Area			Divider Set for Minimum Heat Area		
		120°F % Unload Rate	130°F % Unload Rate	140°F % Unload Rate	120°F % Unload Rate	130°F % Unload Rate	140°F % Unload Rate
In	Out						
15%	13%	620	640	720	520	590	670
16%	13%	420	480	540	390	440	490
17%	13%	340	390	440	310	360	400
18%	13%	290	330	370	270	300	340
19%	13%	250	290	320	230	270	300
20%	13%	220	250	290	210	230	260
21%	13%	200	230	250	180	210	230
23%	13%	160	180	200	150	170	190
25%	13%	130	140	160	120	130	150

Drying Time Table.....Model 1012

Reference Setting Table for Corn -- Model 1012

Moisture		Divider Set for Maximum Heat Area			Divider Set for Minimum Heat Area		
		170°F % Unload Rate	190°F % Unload Rate	210°F % Unload Rate	170°F % Unload Rate	190°F % Unload Rate	210°F % Unload Rate
In	Out						
17%	15%	820	970		780	910	
18%	15%	620	730	850	590	690	790
19%	15%	510	600	690	480	560	640
20%	15%	430	510	590	410	480	550
21%	15%	370	440	530	360	410	470
22%	15%	330	390	450	310	370	420
23%	15%	290	340	400	280	320	370
24%	15%	260	310	350	250	290	330
25%	15%	230	280	320	220	260	300
26%	15%	210	250	280	200	230	270
27%	15%	190	220	260	180	210	240
28%	15%	170	200	230	160	190	210
29%	15%	150	180	210	150	170	190
30%	15%	140	160	190	130	150	180
32%	15%	120	140	160	110	130	150
35%	15%	90	110	120	90	100	120

Reference Setting Table for Wheat, Barley, Milo -- Model 1012

Moisture		Divider Set for Maximum Heat Area			Divider Set for Minimum Heat Area		
		140°F % Unload Rate	150°F % Unload Rate	160°F % Unload Rate	140°F % Unload Rate	150°F % Unload Rate	160°F % Unload Rate
In	Out						
15%	13%	660	730	810	620	690	760
16%	13%	500	550	610	470	530	570
17%	13%	410	450	500	380	430	470
18%	13%	350	380	420	330	360	400
19%	13%	300	330	370	280	310	350
20%	13%	260	290	270	250	280	310
21%	13%	230	260	290	220	250	270
23%	13%	190	210	230	200	200	220
25%	13%	150	170	180	140	160	170

Reference Setting Table for Soybeans -- Model 1012

Moisture		Divider Set for Maximum Heat Area			Divider Set for Minimum Heat Area		
		120°F % Unload Rate	130°F % Unload Rate	140°F % Unload Rate	120°F % Unload Rate	130°F % Unload Rate	140°F % Unload Rate
In	Out						
15%	13%	740	770	860	630	720	810
16%	13%	500	570	640	470	540	600
17%	13%	410	460	520	380	440	490
18%	13%	340	390	440	320	370	420
19%	13%	300	340	390	280	320	360
20%	13%	270	300	340	250	290	320
21%	13%	240	270	300	220	250	290
23%	13%	190	220	240	180	200	230
25%	13%	150	170	190	140	160	180

Drying Time Table.....Model 1015

Reference Setting Table for Corn -- Model 1015

Moisture		Divider Set for Maximum Heat Area			Divider Set for Minimum Heat Area		
		170°F % Unload Rate	190°F % Unload Rate	210°F % Unload Rate	170°F % Unload Rate	190°F % Unload Rate	210°F % Unload Rate
In	Out						
17%	15%				980		
18%	15%	760	900		740	860	980
19%	15%	620	730	850	600	700	800
20%	15%	530	620	720	510	590	680
21%	15%	460	540	650	440	520	590
22%	15%	400	480	550	390	460	520
23%	15%	360	420	490	350	400	460
24%	15%	320	380	440	310	360	410
25%	15%	290	340	390	280	320	370
26%	15%	260	300	350	250	290	330
27%	15%	230	270	320	220	260	300
28%	15%	210	250	280	200	230	270
29%	15%	190	220	260	180	210	240
30%	15%	170	200	230	160	190	220
32%	15%	140	170	200	140	160	180
35%	15%	110	130	150	110	130	140

9. Drying Time Tables

Reference Setting Table for Wheat, Barley, Milo -- Model 1015

Moisture		Divider Set for Maximum Heat Area			Divider Set for Minimum Heat Area		
		140°F % Unload Rate	150°F % Unload Rate	160°F % Unload Rate	140°F % Unload Rate	150°F % Unload Rate	160°F % Unload Rate
In	Out						
15%	13%	820	910	1000	780	860	950
16%	13%	610	680	750	590	650	710
17%	13%	500	560	610	480	530	580
18%	13%	430	470	520	410	450	490
19%	13%	370	410	450	350	390	430
20%	13%	330	360	330	310	340	380
21%	13%	290	320	350	280	310	340
23%	13%	230	260	280	250	240	270
25%	13%	190	210	230	180	200	220

Reference Setting Table for Soybeans -- Model 1015

Moisture		Divider Set for Maximum Heat Area			Divider Set for Minimum Heat Area		
		120°F % Unload Rate	130°F % Unload Rate	140°F % Unload Rate	120°F % Unload Rate	130°F % Unload Rate	140°F % Unload Rate
In	Out						
15%	13%	910	940		790	900	
16%	13%	610	700	790	580	670	750
17%	13%	500	570	640	480	540	610
18%	13%	420	480	550	400	460	520
19%	13%	370	420	480	350	400	450
20%	13%	330	370	420	310	360	400
21%	13%	290	330	370	280	320	360
23%	13%	230	260	300	220	250	280
25%	13%	190	210	240	180	200	230

Pre-season Inspection and Service

The dryer is made of weather-resistant material, and is designed to require minimum service. However, each season we recommend the following items be checked before the unit is used, and any damaged or questionable parts replaced. These checks will help eliminate possible failures, and assure dependable operation of the equipment.

1. Shut off electrical power. Open power box and control box, and inspect for moisture, rodent damage or accumulated foreign material present. Inspect and tighten any loose terminal connections. Replace any damaged or deteriorated wiring.
2. Lubricate the blowers, motors, and metering system as outlined in the lubrication table [on Page 52](#).
3. Inspect and clean the burner. Visually check that no holes in the stainless steel air mixing plates are plugged. If burner ports are plugged, clear them with a piece of wire or a drill bit.
4. Check electrical connections at both the flame rod and spark plug. Clean spark ignitor and flame rod. Replace if necessary.
5. Check drain valve on gas train to ensure that there is no water in the gas train. Valve should always be open when the dryer is not being used. Ensure that drain valve is closed prior to dryer operation.
6. Check the discharge area to ensure that the area is cleaned of stalks and old grain. Inspect the sweeps for excessive wear.

IMPORTANT: *The covers to the discharge sections on the tower dryers must be in place and clamped down at all times when the dryer is in operation. If the cover is off during operation, the vacuum created by the blowers will suck foreign matter from the discharge area and deposit it in the heat section of the dryer plugging the inside screens of the dryer also creating a fire hazard.*

See pre-season check list [on Page 51](#).

Seasonal Inspection and Service

IMPORTANT: *The covers to the metering system access door(s) must be in place at all times when the dryer is in operation. Before turning blowers always make sure this door is clamped into position.*

1. Follow lubrication guides as outlined in the lubrication table.
2. **Do not let grain fines and dust accumulate inside the cooling section of the dryer.** Bi-weekly if drying most products or daily if drying milo, clean the cooling chamber floor of fines and dust. Sweep down the cooling section sheets if necessary. Fines can be swept into the unload systems.
3. **Do not let grain fines and dust accumulate inside the heat section of the dryer.** Daily check the hopper divider that separates the heat section from the cooling section to ensure that it remains clean and open.
4. When cleaning dryer, check the grain discharge area on the dryer. Check the metering sweeps for trash or stalk build ups that could be obstructing grain flow.
5. If undried grain is left in the dryer for more than a week during the drying season, inspect the plenum roof to make sure that there is no wet grain sticking to the roof that could restrict grain flow. When the dryer is restarted make sure that all grain columns are evenly unloading.

10. Service

6. When drying dirty corn in high humidity conditions, sludge may build up in the upper outside sheets of the dryer. This build up can be removed by either washing the sheets down with a high pressure water hose, or by shutting incoming grain, dropping the grain level to below the plugged area, and then running the fans and burner to dry the affected area. Tapping or sweeping the sheets will dislodge debris. Attempting to sweep off the sheet build up while it is still wet will usually plug the sheet more.

In Case of Fire

1. When you first detect a fire, the entire drying operation should be shut down, including grain flow into and out of the dryer. The emergency controls may have already done this. Also, shut off the electrical and fuel supply to the dryer.
2. Do not try to cool a fire by running fan(s).
3. Never run grain from the dryer into the elevator or storage if a fire is known or suspected.
4. Locate the area of the fire.
5. If the fire can be extinguished with a fire extinguisher, water hose or by removing the burning material, this should be done right away. Watch the dryer closely for another fire after one has occurred.
6. Emergency discharge slide gates at the bottom of each column as well as easy access gates located near the hopper discharge area permit fast dumping of each individual grain column.
7. A fire extinguisher should be located at or near the dryer, if a fire seems to be getting out of control call the fire department.

End of Season Service

1. Empty the dryer at the end of the drying season. The dryer should not be used for grain storage. Grain left in there for an extended period of time can become wet, swell and spoil. Chunks of spoiled grain can plug the metering system and swelled grain places undue stress on the interior and exterior sheeting of the dryer.
2. Clean out the plenum roof grain cushion and remove any grain that may be hanging up on the plenum roof.
3. Make sure the grain exchangers are clean.
4. Clean out the hopper that divides the heat section from the cooling section.
5. Clean the cooling chamber floor.
6. Remove all grain and trash from the metering drum floor. This grain can be raked out by hand by opening the slide gates located in the hopper bottom of the dryer.
7. Make sure gas supply is shut off to the dryer.
8. Open the gas train drain valve located on the bottom of the gas train.
9. It is a good practice to cover the burner with a tarpaulin or plastic to ensure a clean burner.

Pre-season Service Check List

- Lubricate blower motor bearings, if needed.
- Clean burner ports.
- Inspect flame rod and spark ignitor.
- Inspect divider hopper between heat and cooling section. Clean if necessary.
- Inspect bindicator grain level switches.
- Check gas pressure gauges.
- Clean control and power panels, tighten loose connections, and check for leaks.
- Inspect metering systems. Clean accumulated stalks and old grain.
- Start-up dryer and check operating controls.
- Other: Itemize _____

End of Season Shut Down Procedure

- Start unload and empty all grain from dryers.
- Clean out grain cushion (on plenum roof under fill spout). Clean plenum roof.
- Clean off grain exchangers.
- Clean out divider hopper, between heating and cooling section.
- Clean inside cooling sheets and cooling floor.
- Remove all grain and trash from unload section of dryer.
- Open emergency grain discharge doors.
- Open drain valve in gas train.
- Cover burner with a tarp or plastic sheeting.

Lubrication Table

Location	Instructions	Type of Lubrication	Lubrication Interval
Accutrol (sweep unload) bottom shaft bearing.	Lubricate slowly until lube shows through seal. Wipe clean.	High quality, grade #2 lithium based grease.	Beginning of season (annually).
Blower motor bearings.	See motor lubrication procedure <i>below</i> .	High quality, grade #2 lithium based grease.	Every 2 years (Normal operation, ever 8-10 months continuous operation).
Metering variable speed drive motor.	See motor lubrication procedure <i>below</i> .	High quality, grade #2 lithium based grease.	Every 2 years (Normal operation, ever 8-10 months continuous operation).
Accutrol sweep gearbox.	Grease filled gearbox. Additional grease does not need to be added.		

1Lubrication of motors - Operate motor for 20 minutes. Clean grease fitting. Remove grease relief plug and using a low pressure grease gun, pump in the required grease. After re-lubricating, allow motor to run for 10 minutes before replacing relief hardware. **DO NOT over grease.**

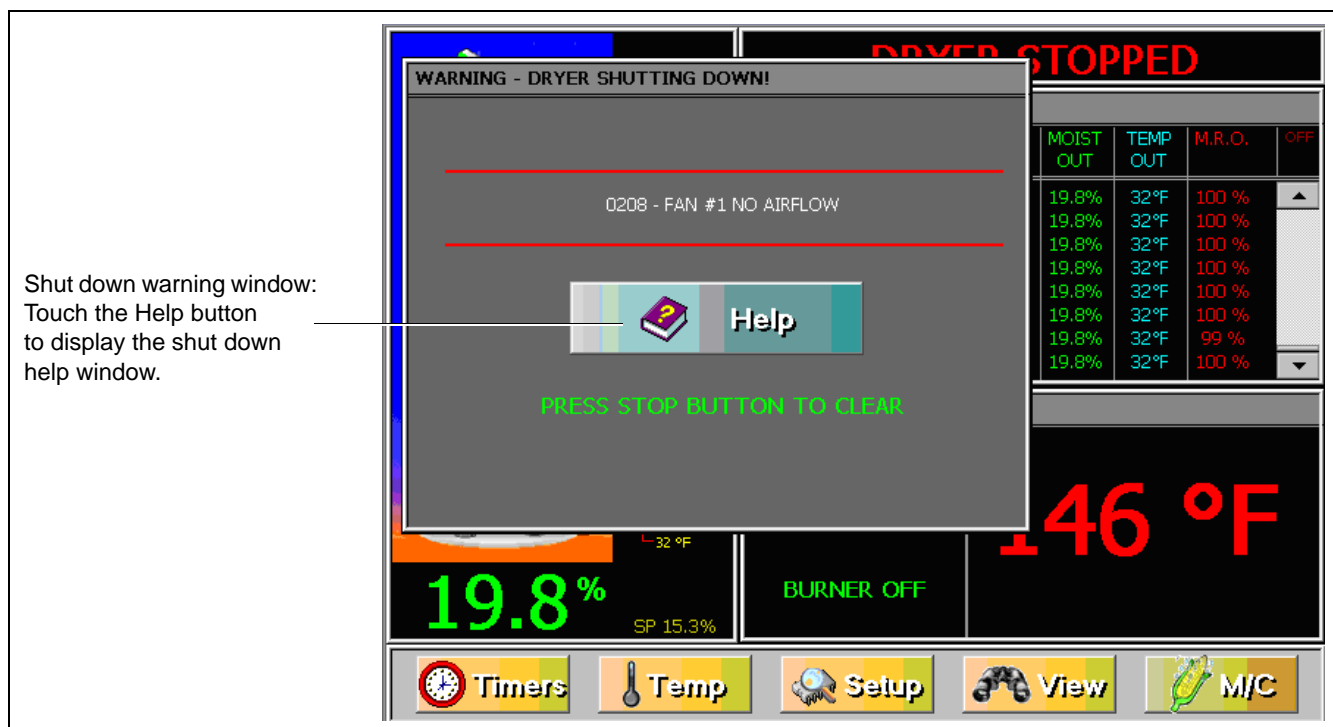

Figure 11A

Fan/Heater Generated Errors

The following is a list of errors that are generated with the fan/heater controller. Each fan/heater has their own set of safeties which are listed below. You will need to inspect the controller associated with the error. **Example:** If you get this error, it is telling you the problem is with housing 1 (bottom most fan) High-Limit. (See [Figure 11A](#).)

Air Switch Stuck

The air switch contacts have closed prior to the fan starting, indicating a freewheeling blade or improper setting of the air switch. The message will distinguish between which fan caused the shut down. This indicates that 12 VDC has been lost to terminal **J4-04** on the Fan/Heater board.

Fan Loss of Airflow

This error message is displayed when airflow (air pressure) has been established but was lost for some reason. This could happen if while during the dryer's operation the grain has settled or shrinkage in the grain columns causing a loss of air pressure in the plenum chamber.

Fan No Airflow

Contacts in the air switch have never opened due to the fan not turning, or the air switch may need adjustment. The message will distinguish between which fan caused the shut down.

Flame Loss

The flame sensor has failed to detect a burner flame which had been established but was lost for some reason and there is a problem with the flame sensing circuitry or the dryer is not getting burner fuel. The message will distinguish between which burner caused the shut down. The reference to the number one (1) is telling you that it is burner number one (1) which is the bottom most fan.

11. Safety Circuit Shut Down Messages

Grain Temp Short

This error indicates there is a shorted condition with one of the grain temperature sensors located inside the left or right grain columns. This could be a shorted sensor or the sensor wires could be shorted.

Grain Overheat

An over temperature condition has occurred in one of the grain columns causing the control to shut down the dryer. This control is set at 210°F (99°C) and automatically resets itself when cool. This can be caused from a grain column plugged with trash or the meter rolls may be adjusted to slow. Feel the grain columns to determine which one may be causing the problems. If all the columns are hot to the touch then you will probably need to check the meter roll settings. If not, then examine the column that feels hot, make sure you can see the grain moving down the column screens. For more information on service see meter roll servicing.

Housing High-Limit

The temperature High-Limit located on the fan/burner housing has opened, indicating an over temperature condition has occurred towards the rear of the fan/heater housing. This control is set at 200°F (93°C) and must be manually reset. The message will distinguish between which fan housing caused the shut down. The reference to the number one (1) is telling you that it is fan number one (1) which is the bottom most fan.

Ignition Failure

This condition happens during the initial ignition of the burner. If the burner fails to light, check to make sure that the gas has been turned ON and/or the maxon valve has been turned ON. The reference to the number one (1) is telling you that it is burner number one (1) which is the bottom most fan.

Illegal Flame

This message is displayed when the flame detection circuit of the heater is sensing flame when the burner is supposed to be OFF. Example, if you shut down the dryer and the heater continues to burn due to a solenoid stuck in an open state, it will generate this type of error.

Motor Overload

One of the thermal overloads on either the fan, load, unload or auxiliary motors has opened, indicating an over current condition. The overloads must be manually reset. The message will distinguish between which fan overload caused the shut down. The reference to the number one (1) is telling you that it is fan number one (1) which is the bottom most fan.

Vapor High-Limit

The LP gas vapor temperature sensor located in the gas pipe train downstream from the vaporizer, has opened indicating that the vaporizer is running too hot and must be readjusted. This sensor is set at 200°F (93°C) and automatically resets itself when cool. The message will distinguish between which burner caused the shut down. The reference to the number one (1) is telling you that it is burner number one (1) which is the bottom most fan/heater unit, is where the malfunction is located. Try adjusting the vaporizer coils farther away from the burners flame. You may also want to try switching the burner mode from High/Low to ON/OFF, especially on warmer days.

Input/Output Generated Errors

The following is a list of errors that are generated with the Input/Output board located in the upper control box.

Air System Failure

A shut down has occurred due to a air system that was installed with an integral Safety switch that was in the unit. The air system safety connections are located in the upper control box on the terminal strip. This can occur if this safety loses 12 VDC to terminal **J1-10** on the Input/Output board. This input is jumpered on the terminal strip when it leaves the factory and is usually installed in the field by a qualified electrician.

Aux Load Overload

The motor overload relay has tripped on the aux load motor circuit located in the upper control box. This can occur if this safety loses 12 VDC to terminal **J1-05** on the Input/Output board. Push the Red button on the overload to reset this error. This is caused from the motor operating with too much of a work load, which in turn uses more current (amperage). If the problem reoccurs then check the motor to make sure it is not being overworked. You may need to call an electrician to measure the motors full load amps (FLA).

Aux Unload Overload

The motor overload relay has tripped on the aux unload motor circuit located in the upper control box. This can occur if this safety loses 12 VDC to terminal **J1-04** on the Input/Output board. Push the Red button on the overload to reset this error. This is caused from the motor operating with too much of a work load, which in turn uses more current (amperage). If the problem reoccurs then check the motor to make sure it is not being overworked. You may need to call an electrician to measure the motors full load amps (FLA).

Load Motor Overload

The motor overload has tripped on the load motor overload located in the upper control box. This can occur if this safety loses 12 VDC to terminal **J1-03** on the Input/Output board. Push the Red button on the overload to reset this error. This is caused from the motor operating with too much of a work load, which in turn uses more current (amperage). If the problem reoccurs then check the motor to make sure it is not being overworked. You may need to call an electrician to measure the motors full load amps (FLA).

Meter Rolls Failed

If you have the meter roll speed adjustment turned too low (not turning), this will cause this error message. It also could indicate that you have a defective meter roll sensor, the metering roll drive system has failed to turn or broken chain or jammed metering roll is a possibility. This can occur if the input is not receiving a 5 volt pulse on terminal **J4-04** on the Input/Output board.

Out of Grain

The dryer has run low on grain, and the out of grain timer has timed out, shutting the dryer down. The unload auger will continue to run so it can clean out the remaining grain before shutting down.

Unload Motor Overload

The motor overload has tripped on the unload motor overload located in the upper control box. This indicates that 12 VDC has been lost to terminal **J1-02** on the Input/Output board. Push the Red button on the overload to reset this error. This is caused from the motor operating with too much of a work load, which in turn uses more current (amperage). If the problem reoccurs then check the motor to make sure it is not being overworked. You may need to call an electrician to measure the motor's full load amps (FLA).

User Safety

A shut down has occurred due to a user installed Safety switch that was installed on the dryer. The user installed safety connections are located in the upper control box on the terminal strip. This also indicates that 12 VDC has been lost to terminal **J2-01** on the Input/Output board. This input is jumpered on the terminal strip when it leaves the factory and is usually installed in the field by a qualified electrician.

Master Display Generated Errors

The following is a list of errors that are generated with the Master Display board located in the lower control box.

Cont-Batch Mode Chng

This error occurs when you switch the Dryer Mode switch from the continuous flow to the staged batch position while the dryer is running in the continuous flow mode. To avoid this shut down, stop the dryer before switching modes. Press stop to clear the error.

Network Failed FH

This error is generated whenever Fan/Heater board has lost its communications link with the Input/Output board (upper control panel) and the Master Display board (lower control panel). Check the ethernet cable jacks to make sure they are plugged in tightly. An ethernet cable is a computer communication cable that looks like the phone cable in the home. *(See Figure 11B on Page 57.)*

The reference to the number one (FH1) is telling you that it is fan number one (1) which is the bottom most fan.

Network Failed Input/Output

This error is generated whenever Input/Output board (upper control panel) has lost its communications link with the master (lower control panel door) and the Fan/Heater boards. Check the ethernet cable jacks to make sure they are plugged in tightly. There are three (3) LED lights next to this plug, one (1) indicates power and the other two (2) indicate data being transmitted. These two (2) labeled RXD and TXD, should be flashing randomly back and forth indicating network activity.

Network Failed Mast

This error is generated whenever Master Display board (lower control panel) has lost its communications link with the Input/Output board (upper control panel door) and the Fan/Heater boards. Check the ethernet cable jacks to make sure they are plugged in tightly.

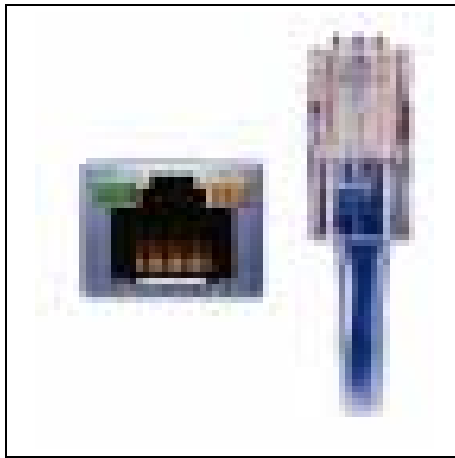

Figure 11B

Plenum Temp Open

This error indicates there is a open condition with the plenum temperature sensor located inside the plenum chamber. This could be a open sensor or the sensor wires could have a open connection.

Plenum Temp Short

This error indicates there is a shorted condition with the plenum temperature sensor located inside the plenum chamber. This could be a shorted sensor or the sensor wires could be shorted.

Plenum Overheat

An over temperature condition has occurred inside the dryer plenum. This control is a 300°F (149°C) limit and automatically resets itself when cool. The message will distinguish between which plenum caused the shut down.

Power Box Back Panel Wiring

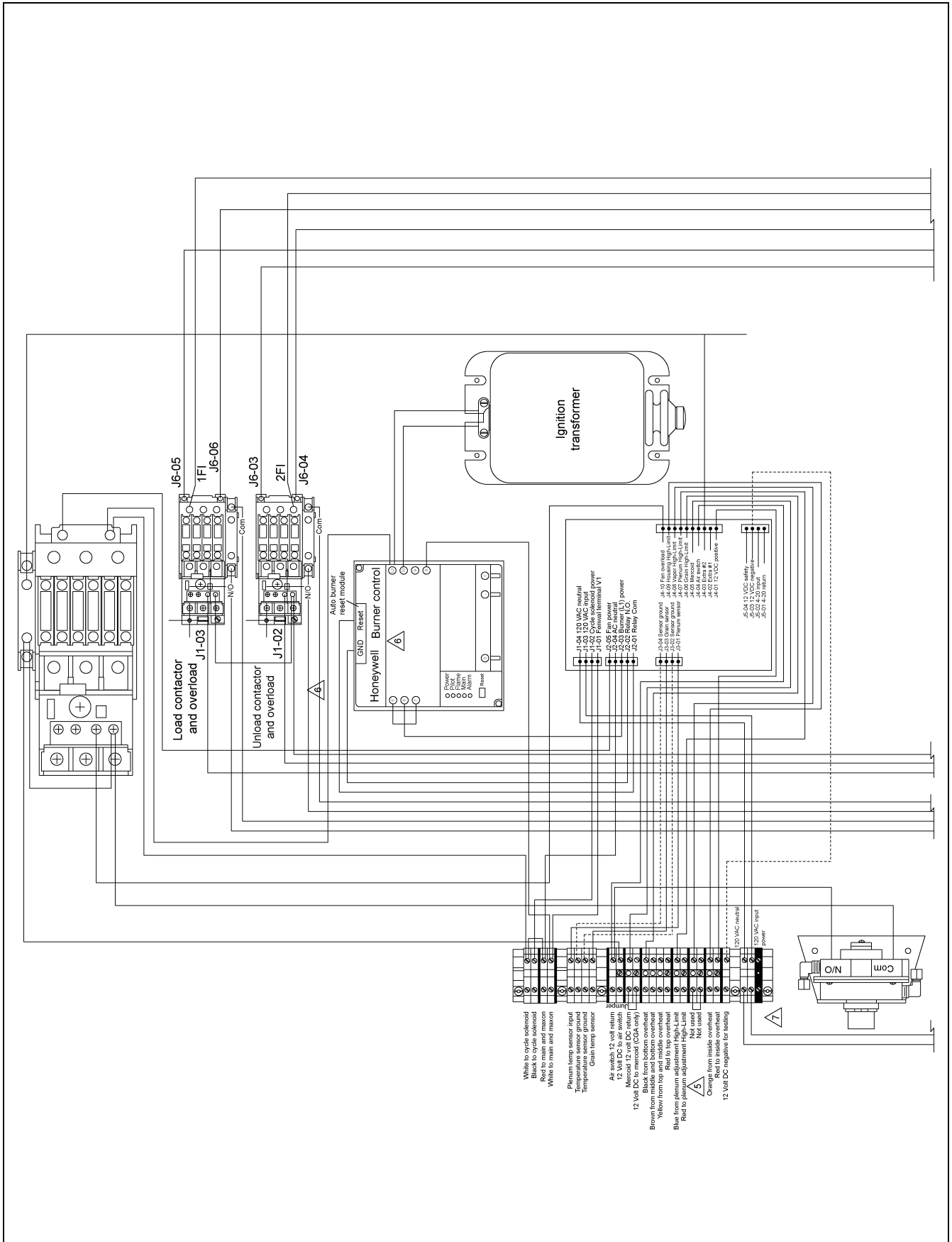

Power Box Back Panel Wiring (Continued)

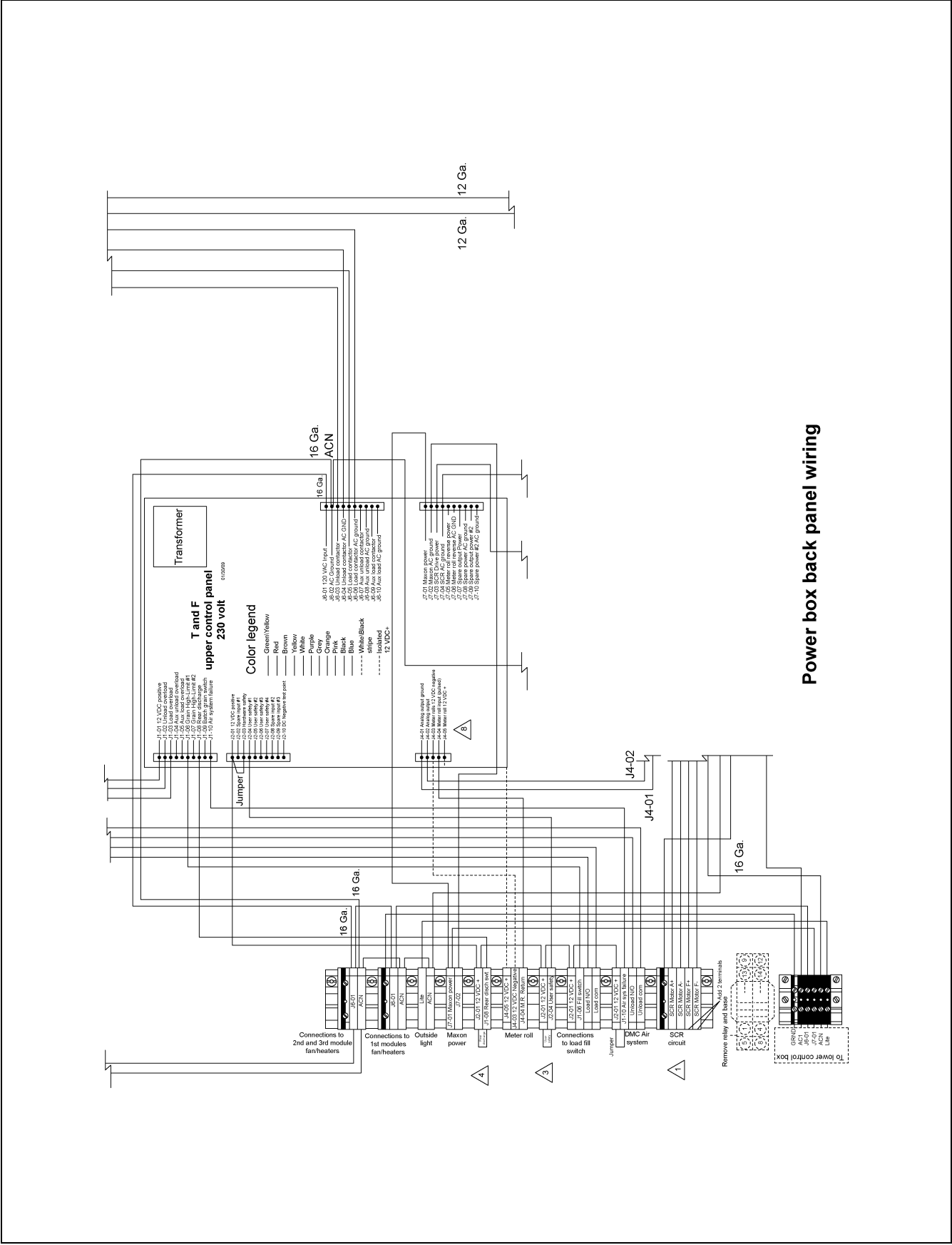

Power box back panel wiring

Power Box Back Panel Wiring (Continued)

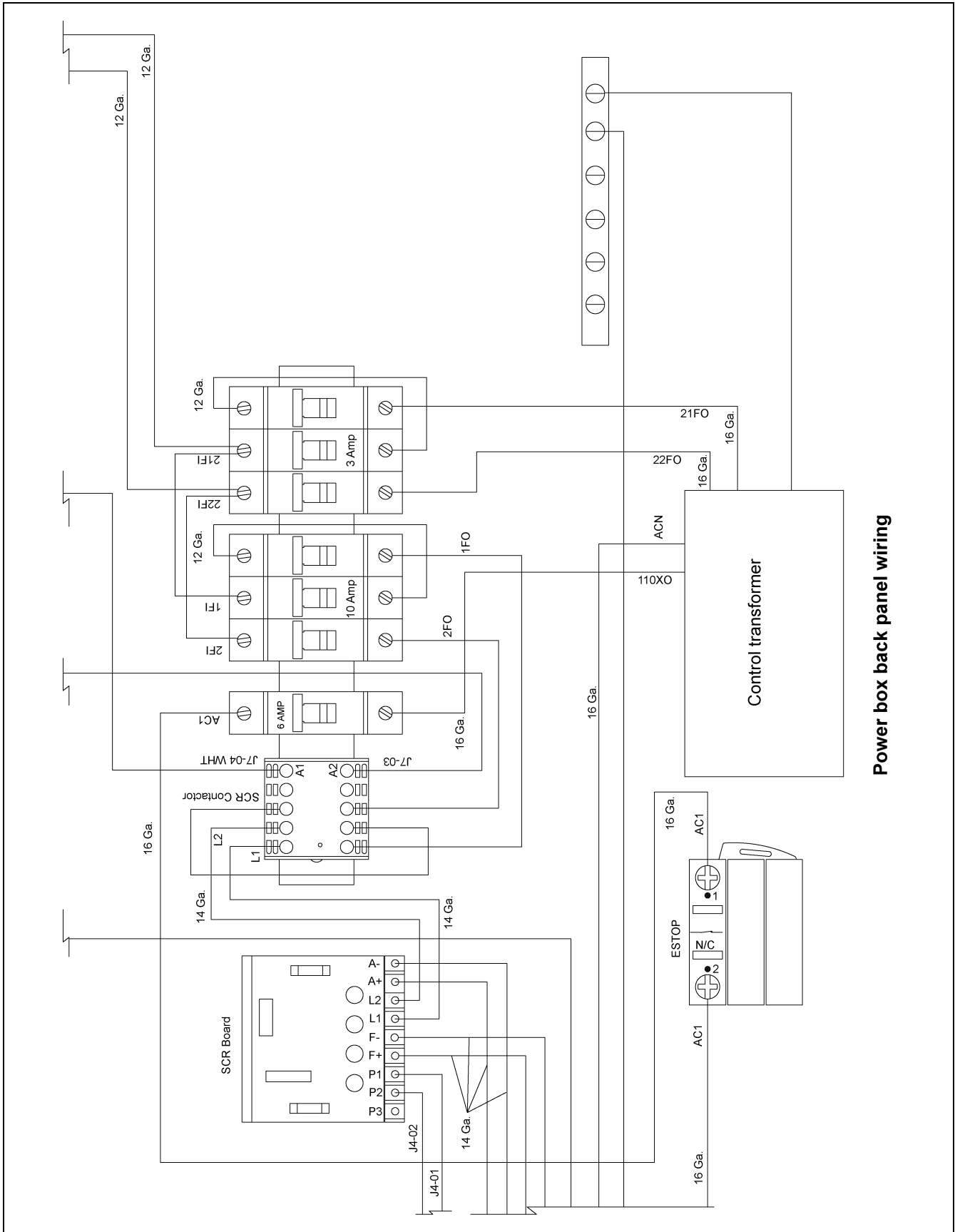

Power box back panel wiring

Fan/Heater Board Wiring

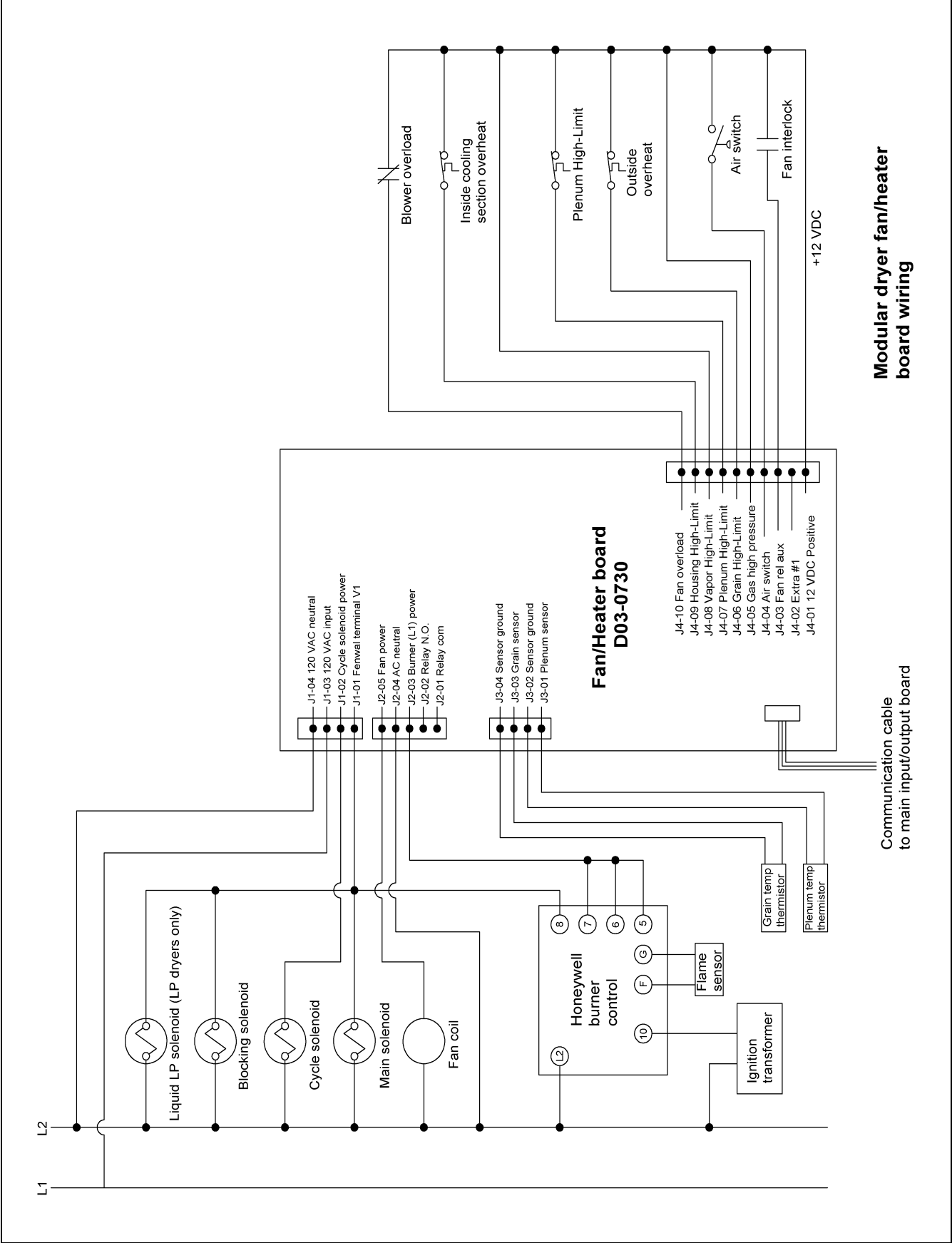

Modular dryer fan/heater board wiring

Communication cable to main input/output board

Main Input/Output Power Box Wiring

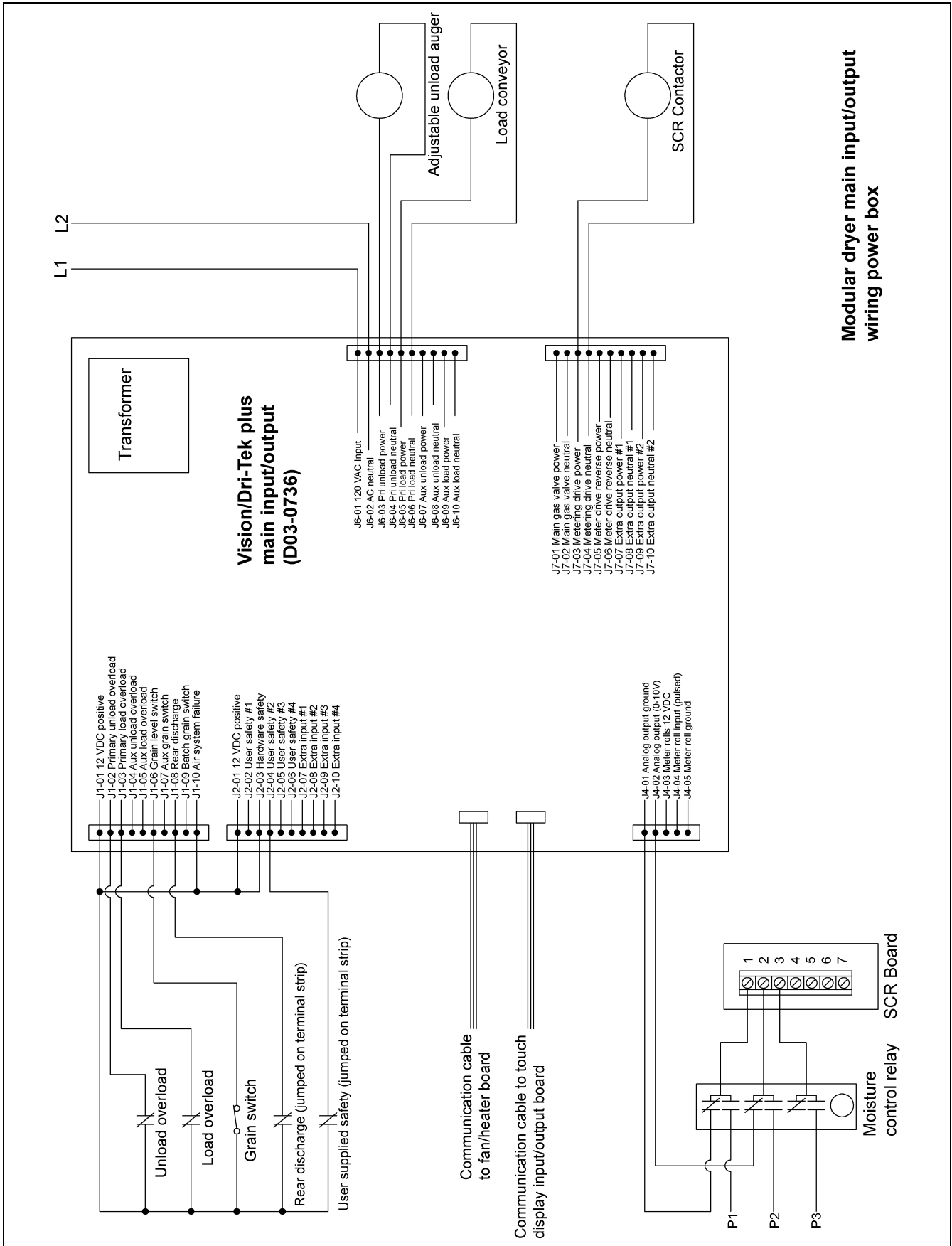

Top Terminal Strip Power Box

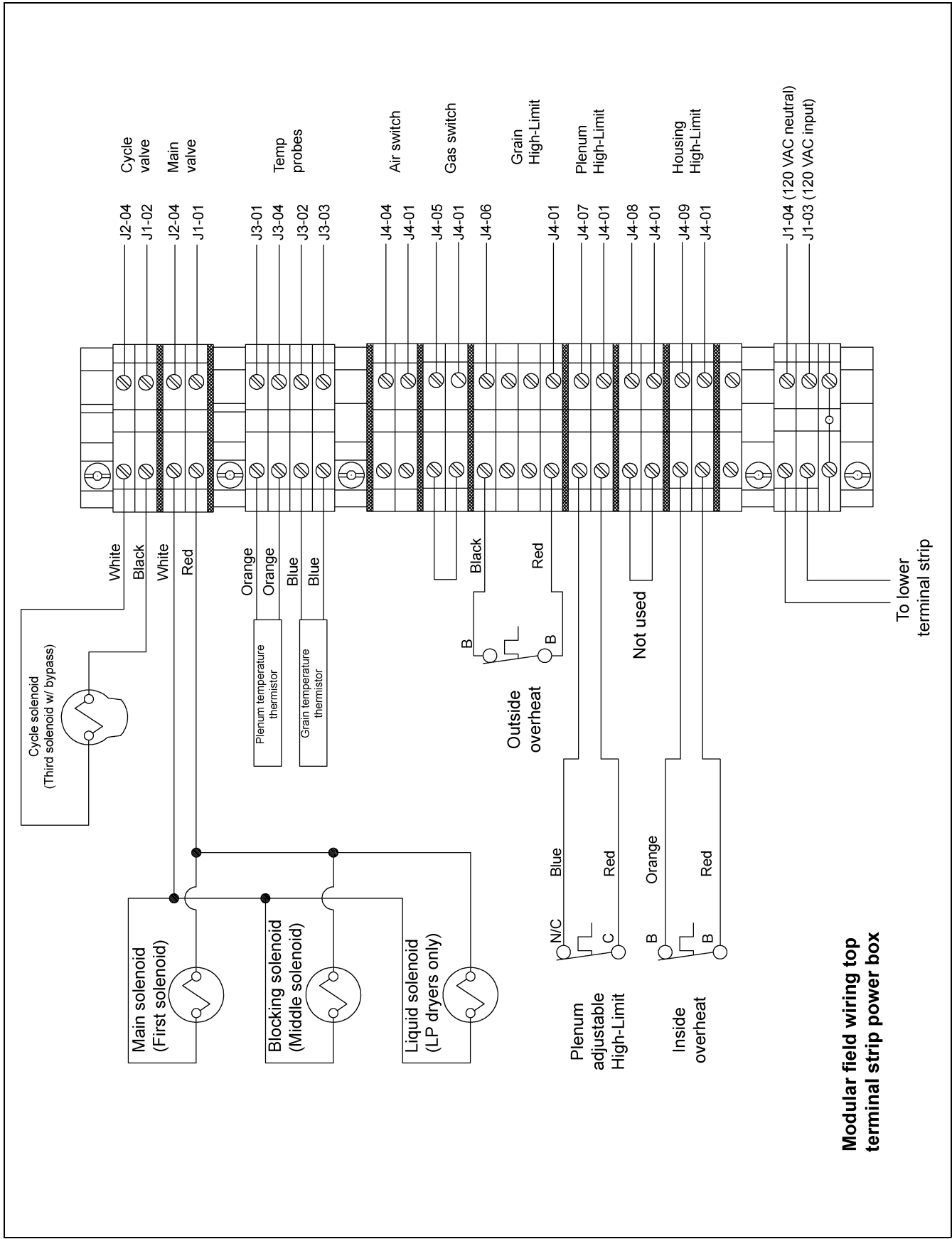

Bottom Terminal Strip Power Box

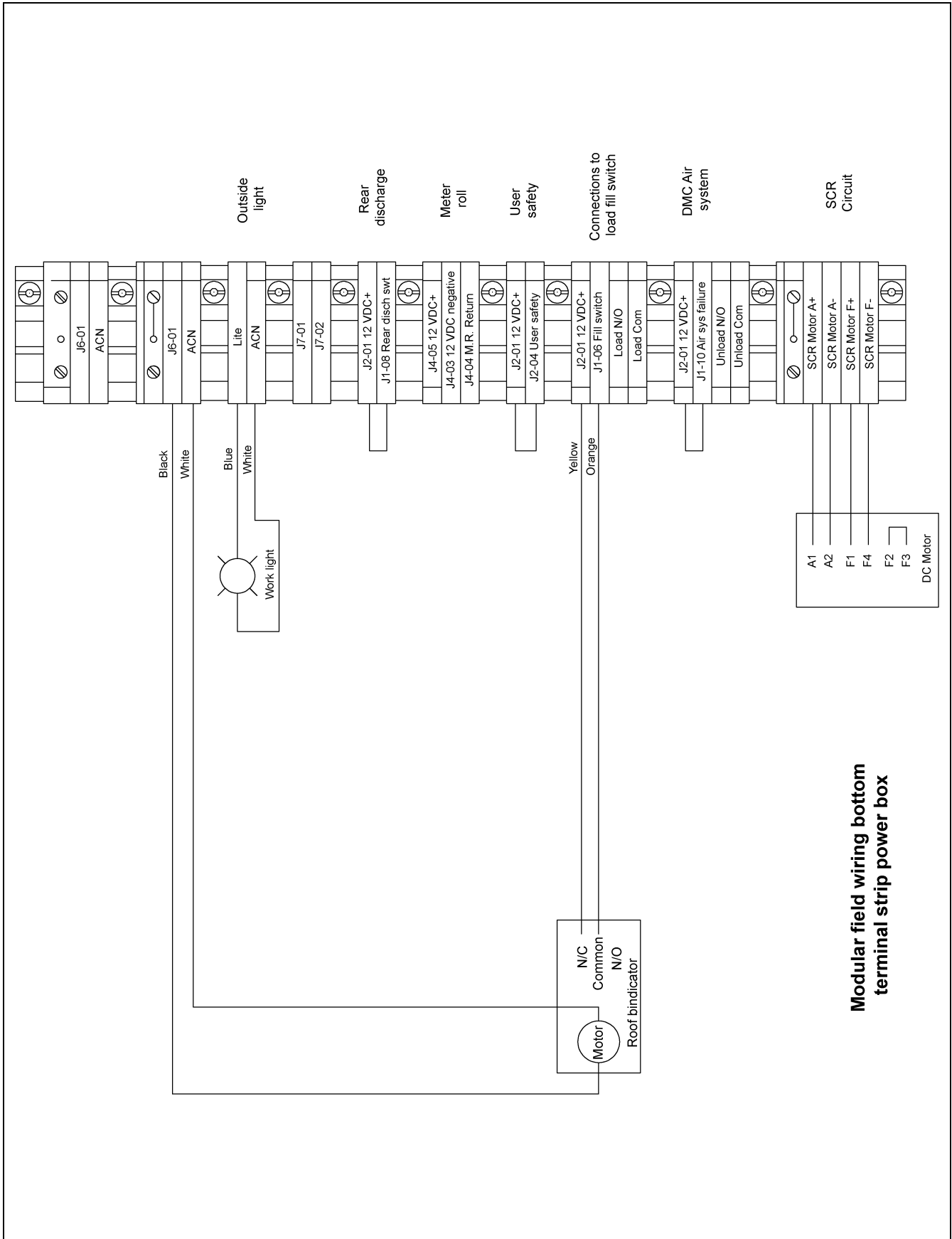

Burner Control Wiring

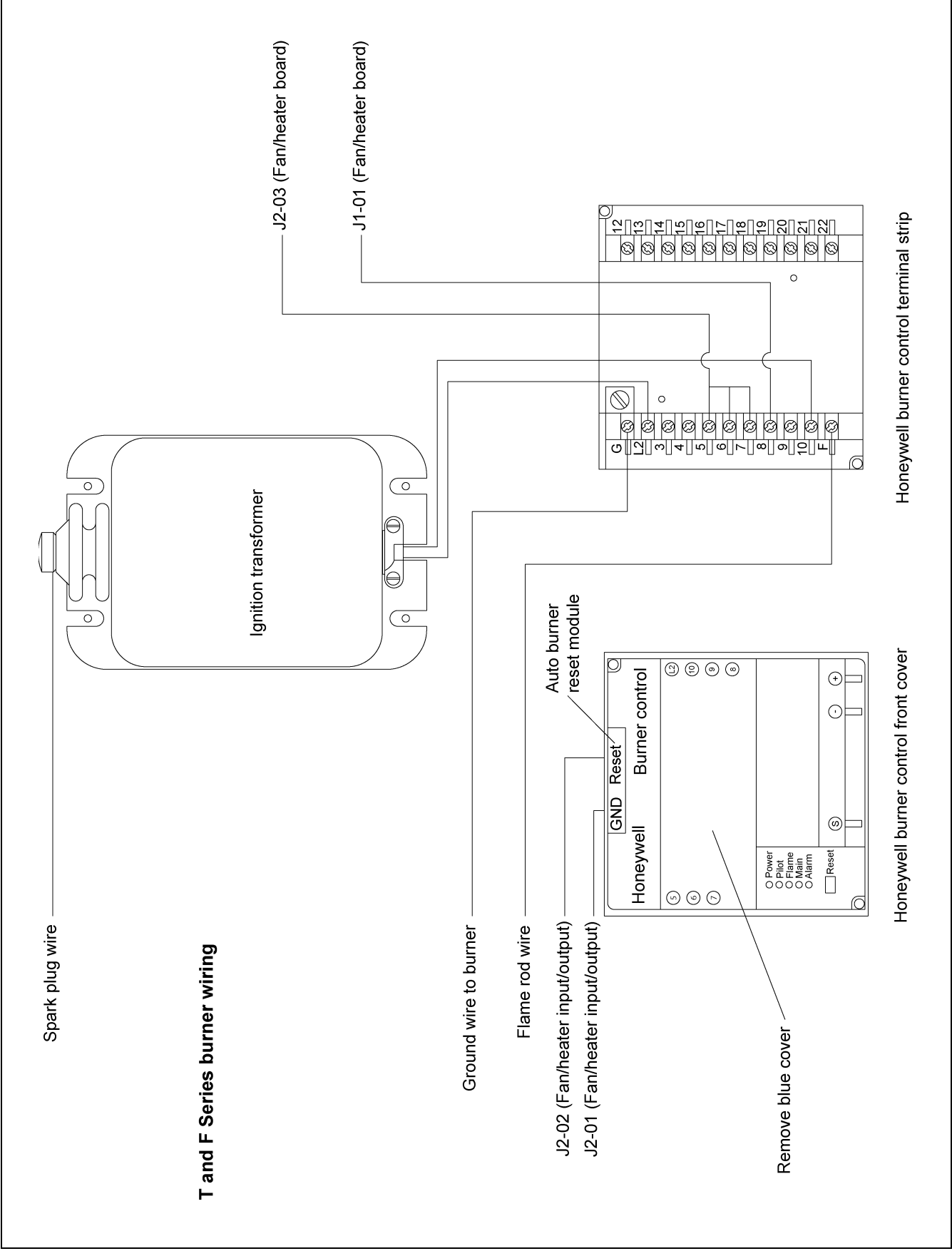

DC Motor Wiring

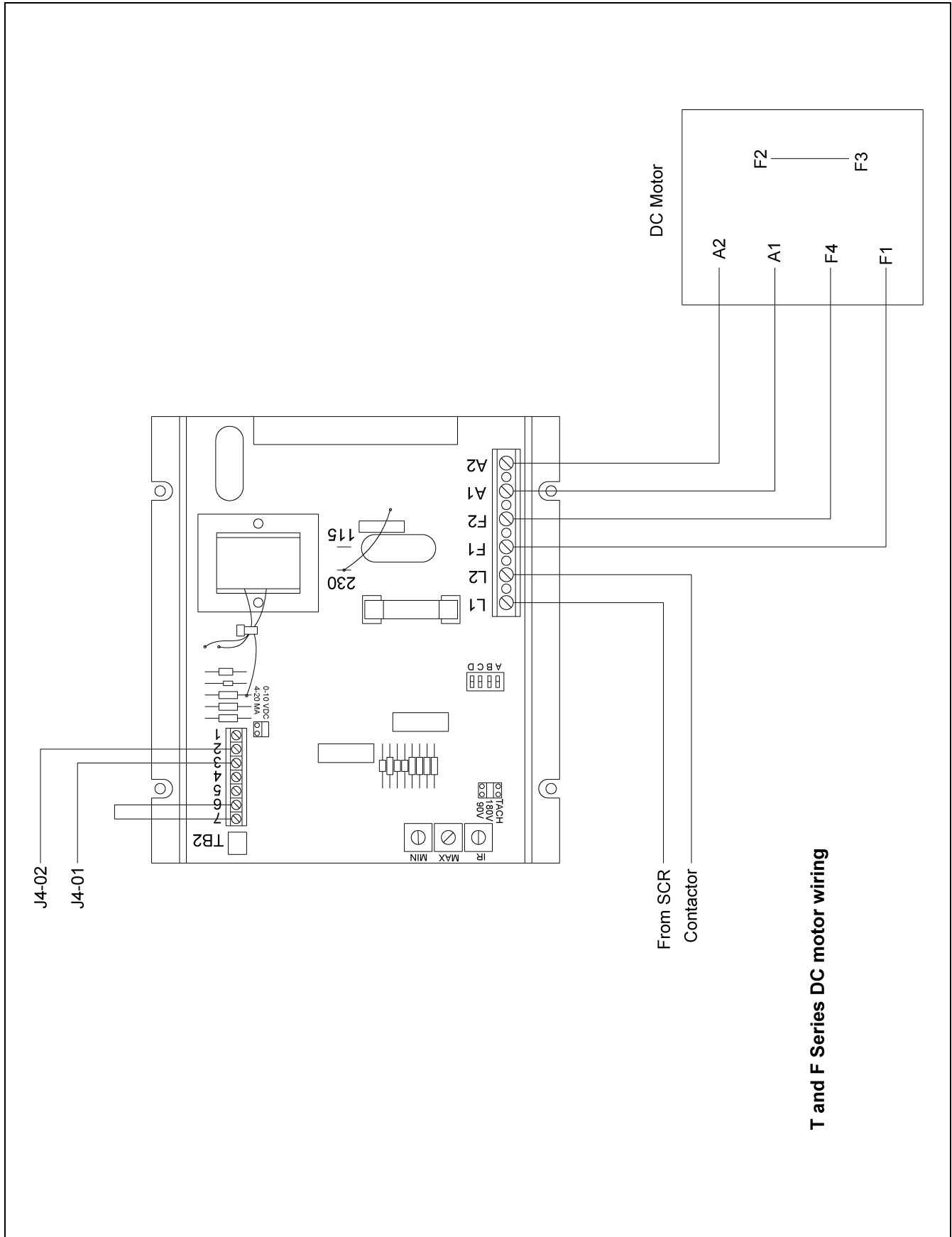

Fan Contactor and Overload (ACL)

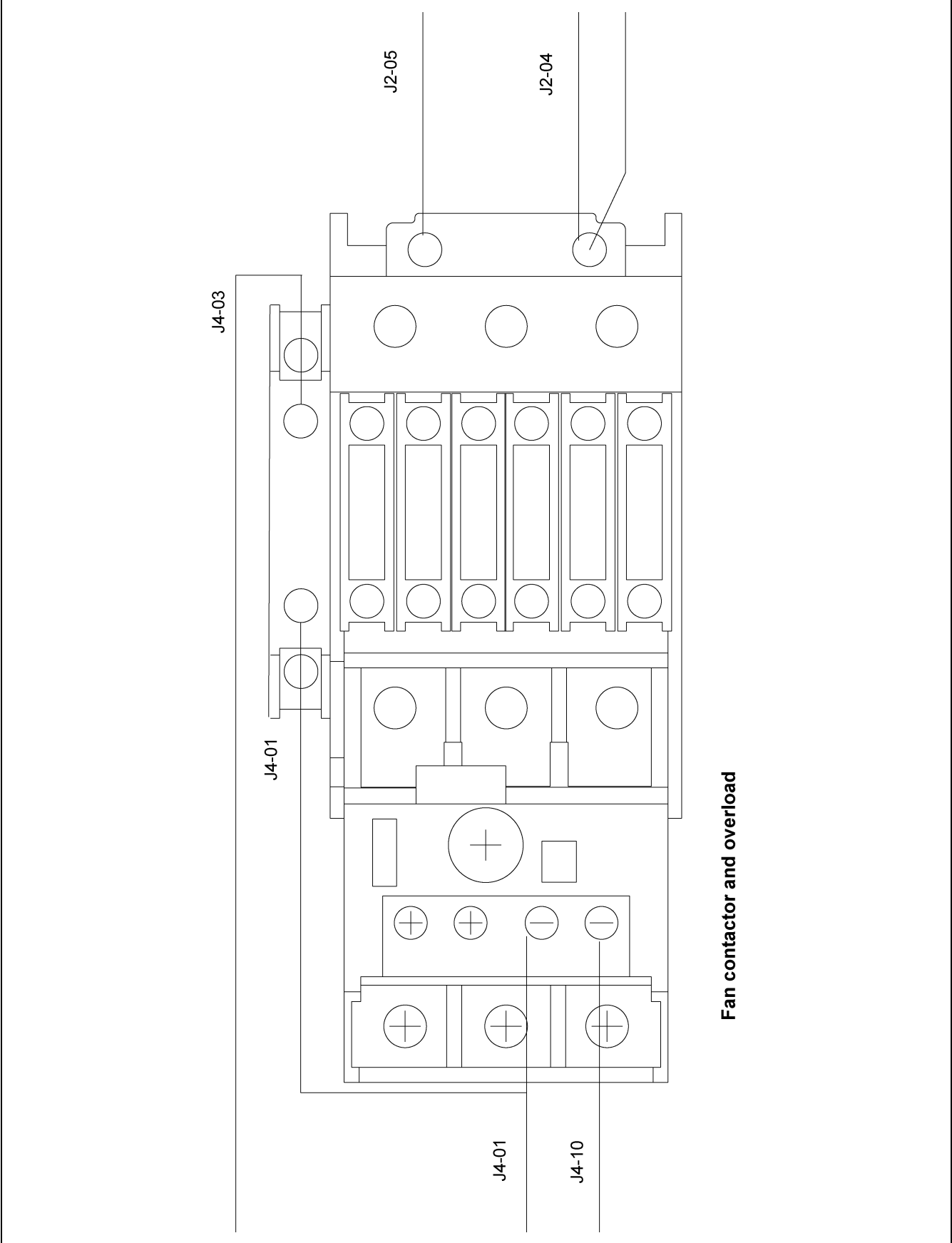

Fan contactor and overload

Fan Contactor Part Winding Starter

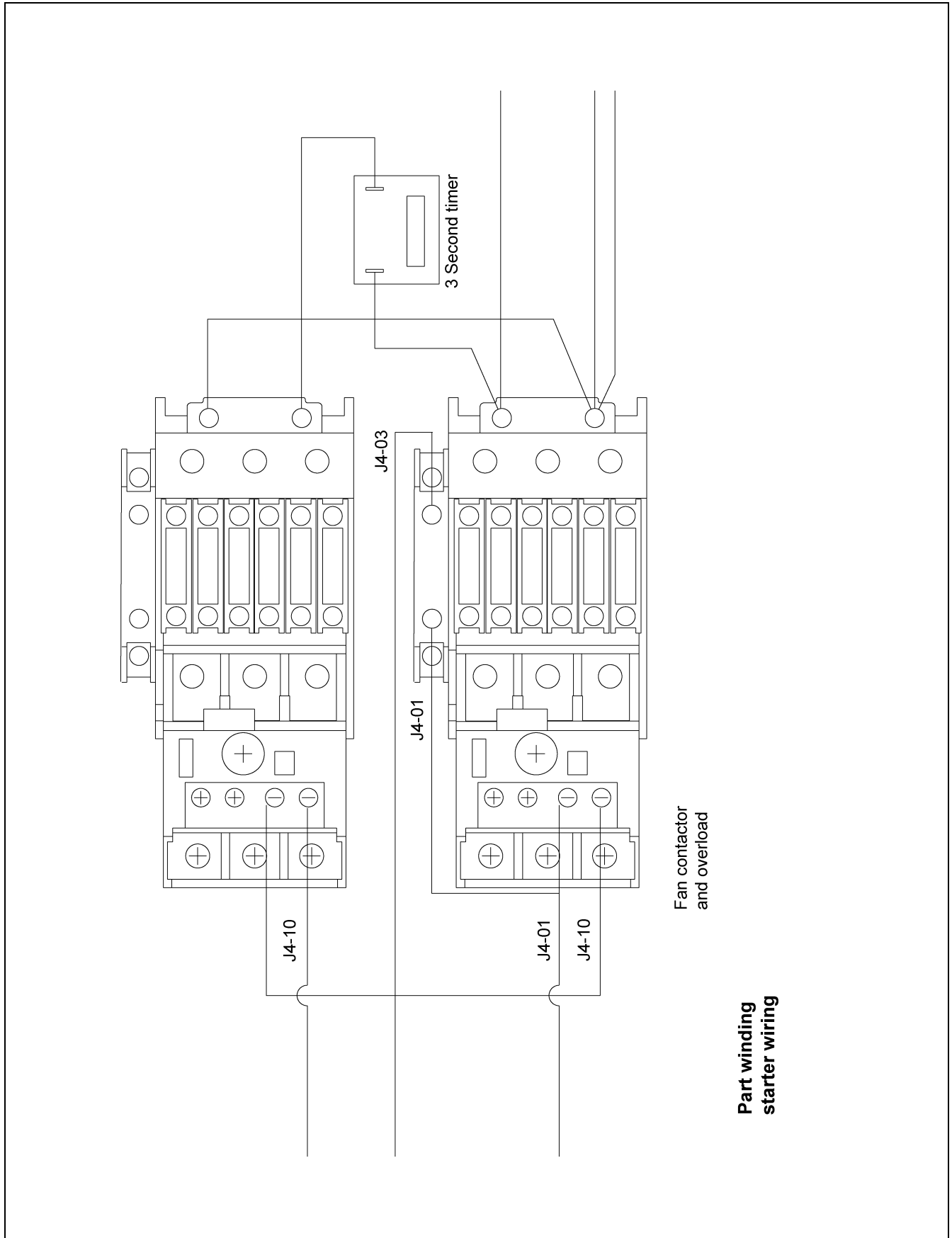

Fan Contactor Soft Starter

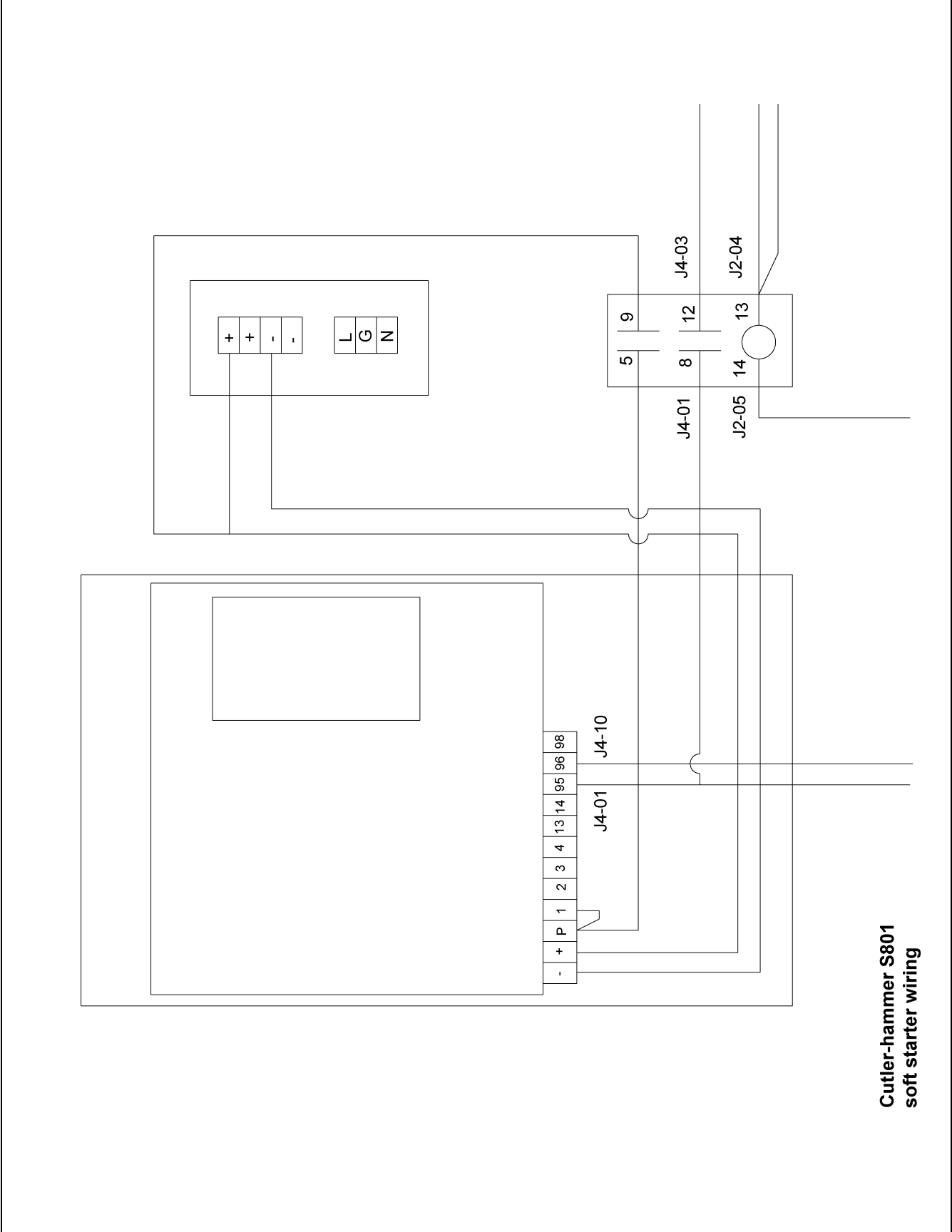

Cutler-hammer S801 soft starter wiring

Moisture Sensor Wiring

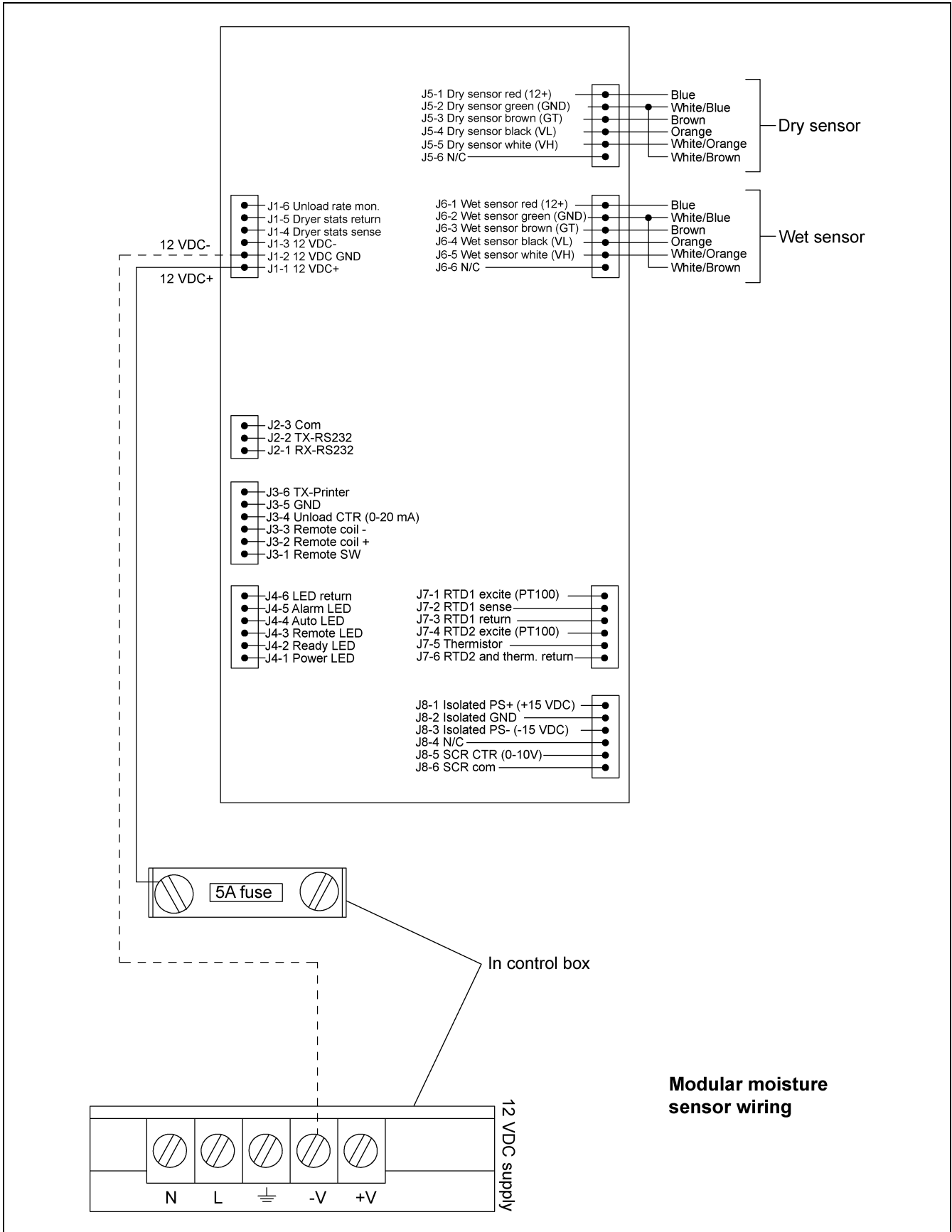

GSI Group, LLC Limited Warranty

The GSI Group, LLC ("GSI") warrants products which it manufactures to be free of defects in materials and workmanship under normal usage and conditions for a period of 12 months after sale to the original end-user or if a foreign sale, 14 months from arrival at port of discharge, whichever is earlier. The end-user's sole remedy (and GSI's only obligation) is to repair or replace, at GSI's option and expense, products that in GSI's judgment, contain a material defect in materials or workmanship. Expenses incurred by or on behalf of the end-user without prior written authorization from the GSI Warranty Group shall be the sole responsibility of the end-user.

Warranty Extensions:

The Limited Warranty period is extended for the following products:

	Product	Warranty Period	
AP Fans and Flooring	Performer Series Direct Drive Fan Motor	3 Years	* Warranty prorated from list price: 0 to 3 years - no cost to end-user 3 to 5 years - end-user pays 25% 5 to 7 years - end-user pays 50% 7 to 10 years - end-user pays 75%
	All Fiberglass Housings	Lifetime	
	All Fiberglass Propellers	Lifetime	
Cumberland Feeding/Watering Systems	Feeder System Pan Assemblies	5 Years **	** Warranty prorated from list price: 0 to 3 years - no cost to end-user 3 to 5 years - end-user pays 50%
	Feed Tubes (1-3/4" and 2.00")	10 Years *	
	Centerless Augers	10 Years *	
	Watering Nipples	10 Years *	
Grain Systems	Grain Bin Structural Design	5 Years	
Grain Systems Farm Fans Zimmerman	Portable and Tower Dryers	2 Years	† Motors, burner components and moving parts not included. Portable dryer screens included. Tower dryer screens not included.
	Portable and Tower Dryer Frames and Internal Infrastructure †	5 Years	

GSI further warrants that the portable and tower dryer frame and basket, excluding all auger and auger drive components, shall be free from defects in materials for a period of time beginning on the twelfth (12th) month from the date of purchase and continuing until the sixtieth (60th) month from the date of purchase (extended warranty period). During the extended warranty period, GSI will replace the frame or basket components that prove to be defective under normal conditions of use without charge, excluding the labor, transportation, and/or shipping costs incurred in the performance of this extended warranty.

Conditions and Limitations:

THERE ARE NO WARRANTIES THAT EXTEND BEYOND THE LIMITED WARRANTY DESCRIPTION SET FORTH ABOVE. SPECIFICALLY, GSI MAKES NO FURTHER WARRANTY OF ANY KIND, EXPRESS OR IMPLIED, INCLUDING, WITHOUT LIMITATION, WARRANTIES OF MERCHANTABILITY OR FITNESS FOR A PARTICULAR PURPOSE OR USE IN CONNECTION WITH: (I) PRODUCT MANUFACTURED OR SOLD BY GSI OR (II) ANY ADVICE, INSTRUCTION, RECOMMENDATION OR SUGGESTION PROVIDED BY AN AGENT, REPRESENTATIVE OR EMPLOYEE OF GSI REGARDING OR RELATED TO THE CONFIGURATION, INSTALLATION, LAYOUT, SUITABILITY FOR A PARTICULAR PURPOSE, OR DESIGN OF SUCH PRODUCTS.

GSI shall not be liable for any direct, indirect, incidental or consequential damages, including, without limitation, loss of anticipated profits or benefits. The sole and exclusive remedy is set forth in the Limited Warranty, which shall not exceed the amount paid for the product purchased. This warranty is not transferable and applies only to the original end-user. GSI shall have no obligation or responsibility for any representations or warranties made by or on behalf of any dealer, agent or distributor.

GSI assumes no responsibility for claims resulting from construction defects or unauthorized modifications to products which it manufactured. Modifications to products not specifically delineated in the manual accompanying the equipment at initial sale will void the Limited Warranty.

This Limited Warranty shall not extend to products or parts which have been damaged by negligent use, misuse, alteration, accident or which have been improperly/inadequately maintained. This Limited Warranty extends solely to products manufactured by GSI.

Prior to installation, the end-user has the responsibility to comply with federal, state and local codes which apply to the location and installation of products manufactured or sold by GSI.

This equipment shall be installed in accordance with the current installation codes and applicable regulations which should be carefully followed in all cases. Authorities having jurisdiction should be consulted before installations are made.

G S I G R O U P



GSI Group
1004 E. Illinois St.
Assumption, IL 62510-0020
Phone: 1-217-226-4421
Fax: 1-217-226-4420
www.gsiag.com