



CE Approved PLC Tower Dryers

Operators Manual

PNEG-1796

Date: 03-14-11



GSI GROUP



PNEG-1796

This product is protected under one or more of the following U.S. patents:

6233843, 6189235, 6141886, 6101742, 6098305, 6088929, 6076276, 6073367, 6073364, 5570521,
6457256, 6035544, 5860221, 5653043, 5651193, 5604996, 5566470, 5400525

Contents

Chapter 1 Safety	4
Safety Guidelines	4
Tower Dryer Operations and Service	5
Safety Precautions	5
Chapter 2 Decals	7
Chapter 3 Installation Requirements	12
Electrical	12
Tower Dryer Power Requirements	12
Fuel	13
2" CE Tower Dryer Pipe Train Assembly	15
PLC Dryer Control Panel	19
Chapter 4 Dryer Commissioning	22
Electrical	22
Gas Train	22
Chapter 5 Dryer Operation	24
Start-Up	24
Shut Down	28
Viewing Temperature/Moisture History	28
Viewing Burner/Fuel Train Status	28
Viewing Grain Flow Status	28
Modifying the Bushel Per Hour Factor	28
Chapter 6 Tri-Point Moisture Controller	30
Control Operation Principles	30
Set-Up Controller	31
Operation Procedure	32
Alarms	33
Access Drying History	33
Chapter 7 Maintenance	35
Pre-Season Inspection and Service	35
Mid Season Inspection and Service	36
In Case of Fire	37
End of Season Service	37
Lubrication Table	38
Chapter 8 Troubleshooting	39
Troubleshooting - Drying Issues	39
Troubleshooting - Burner	40
Troubleshooting - General	41
Troubleshooting - OIU (Screen) Messages	42
Chapter 9 Tower Dryer Control Panel Wiring Diagrams	45
Chapter 10 Warranty	71

Safety Guidelines

This manual contains information that is important for you, the owner/operator, to know and understand. This information relates to protecting **personal safety** and **preventing equipment problems**. It is the responsibility of the owner/operator to inform anyone operating or working in the area of this equipment of these safety guidelines. To help you recognize this information, we use the symbols that are defined below. Please read the manual and pay attention to these sections. Failure to read this manual and its safety instructions is a misuse of the equipment and may lead to serious injury or death.



This is the safety alert symbol. It is used to alert you to potential personal injury hazards. Obey all safety messages that follow this symbol to avoid possible injury or death.



DANGER indicates a hazardous situation which, if not avoided, will result in death or serious injury.



WARNING indicates a hazardous situation which, if not avoided, could result in death or serious injury.



CAUTION, used with the safety alert symbol, indicates a hazardous situation which, if not avoided, could result in minor or moderate injury.



NOTICE is used to address practices not related to personal injury.

Tower Dryer Operations and Service

This manual contains important information that all owners/operators must understand, relating to:

1. Personal safety
2. Preventing equipment problems

The owner/operator must inform anyone operating or working around this equipment of these safety guidelines.

Failure to read this manual and it's safety instructions is a misuse of the equipment and may lead to serious injury or death

Safety Precautions

1. Read the operating manual.
2. Electrical installation must be in accordance with relevant IEC standards, EU Directives and Local Codes/Regulations.
3. The entire dryer must be electrically earthed.
4. Gas/liquid fuel supply must be in accordance with European Standards, EU Directives and Local Codes/Regulations.
5. **NEVER** operate the dryer without guards in place.
6. **DISCONNECT** and **LOCK OUT** all power and fuel before adjusting, servicing, accessing or entering the dryer or associated equipment.
7. **NEVER** bypass any safety device.
8. Observe recommended drying temperatures.
9. Keep the dryer clean throughout.
10. Use **CAUTION**. The dryer and associated equipment may **START AUTOMATICALLY**.
11. Keep fan inlets clear of any foreign objects.
12. Auxiliary equipment capacity must be matched to the dryer.
13. Keep drive belts correctly tensioned.
14. Dry clean grain only for optimum performance.
15. Dryer operators must be trained and competent.
16. Follow required maintenance procedures and intervals.

1. Safety

Use Caution in the Operation of this Equipment

This dryer is designed and manufactured with operator safety in mind. However, the very nature of a grain dryer having a gas burner, high voltage electrical equipment and high speed rotating parts, presents hazards to personnel which cannot be completely safeguarded against without interfering with the efficient operation of the dryer and reasonable access to its components.

Use extreme caution in working around high speed fans, gas-fired heaters, augers and auxiliary conveyors, which may start without warning when the dryer is operating on automatic control.



Keep the dryer clean. Do not allow fine material to accumulate in the plenum chamber or surrounding the outside of the dryer.

Continued safe, dependable operation of automatic equipment depends, to a great degree, upon the owner. For a safe and dependable drying system, follow the recommendations within the Owner's Manual and make it a practice to regularly inspect the unit for any developing problems or unsafe conditions.

Take special note of the safety precautions [on Page 5](#) before attempting to operate the dryer.

Safety decals must be read and understood by all people in and around the dryer area. If any safety decals are not displayed on the dryer or if they are damaged, contact The GSI Group, Inc. for replacement:

Decals

1004 E. Illinois St.
Assumption, IL. 62510
Phone: 1-217-226-4421

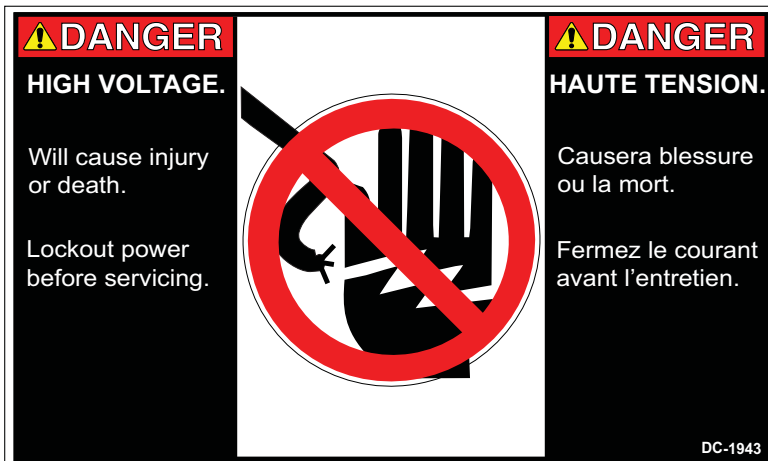

DC-1943

Background: White
Colors: Black, ANSI Yellow (Pantone 108C) and Safety Red (PMS 179C)
Size: 5.000" x 3.000"

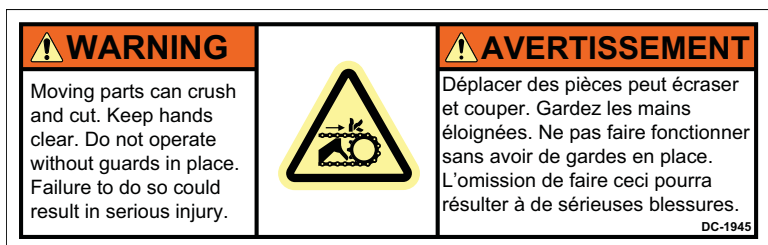

DC-1945

Background: White
Colors: Black, Safety Orange (PMS 152C) and Safety Yellow (PMS 109C)
Size: 4.375" x 1.500"

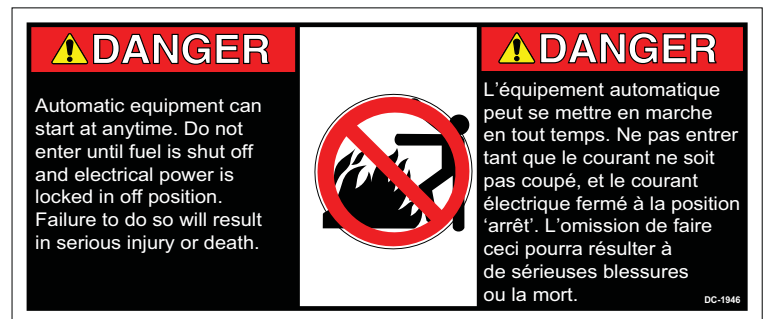

DC-1946

Background: White
Colors: Black, ANSI Yellow (Pantone 108C) and Safety Red (PMS 179C)
Size: 4.375" x 1.500"

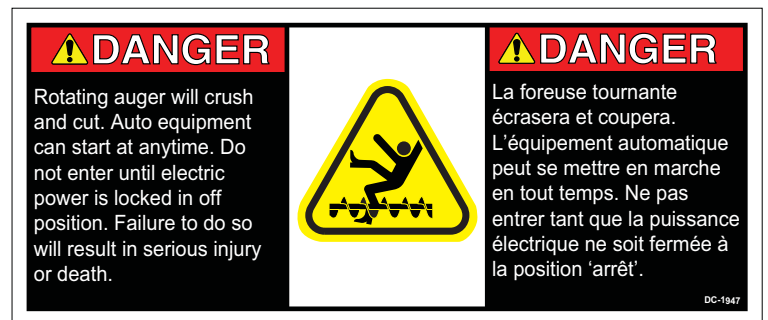

DC-1947

Background: White
Colors: Black, ANSI Yellow (Pantone 108C) and Safety Yellow (PMS 109C)
Size: 4.375" x 1.375"

2. Decals

<p>⚠ DANGER HIGH VOLTAGE. Will cause serious injury or death. Lockout power before servicing.</p>		<p>⚠ DANGER HAUTE TENSION Causera de sérieuses blessures ou la mort. Vérouillez le courant avant l'entretien.</p>
--	---	--

DC-1948

Background: White
 Colors: Black, ANSI Yellow (Pantone 108C) and Safety Red (PMS 179C)
 Size: 4.375" x 1.375"



CONFINED SPACE
ESPACE HORS LIMITE



AUTHORIZED PERSONNEL ONLY
PERSONNEL AUTORISÉ SEULEMENT

DC-1961

DC-1961

Background: White
 Colors: Black, White and Safety Red (RGB FF000)
 Size: 7.000" x 5.000"

<p>⚠ DANGER AMPUTATION HAZARD. Rotating drum below. Will cause serious injury or death. LOCKOUT power before entering or servicing.</p>		<p>⚠ DANGER RISQUE D'AMPUTATION. Tambour rotatif ci-dessous. Cause de sérieuses blessures ou la mort. Éteindre le courant avant d'entrer ou de faire l'entretien.</p>
--	---	---

DC-2020

Background: White
 Colors: Black, ANSI Yellow (Pantone 108C) and Safety Red (PMS 179C)
 Size: 5.000" x 3.000"

<p>⚠ WARNING Flame and pressure beyond door. May cause serious injury. Do not enter when dryer is running.</p>		<p>⚠ AVERTISSEMENT Pression et flamme au-delà de cette porte. Peut causer des blessures sérieuses. Ne pas entrer quand le séchoir est en marche.</p>
--	---	--

DC-2021

Background: White
 Colors: Black, Safety Orange (PMS 152C) and Safety Yellow (PMS 109C)
 Size: 4.875" x 3.000"

<p>⚠ DANGER</p> <p>DO NOT STAND ON DRUM!</p> <p>Rotating drum will cause serious injury or death.</p> <p>Disconnect power before servicing.</p>		<p>⚠ DANGER</p> <p>NE PAS SE METTRE DEBOUT SUR LE TAMBOUR!</p> <p>Le tambour rotatif causera de sérieuses blessures ou la mort.</p> <p>Débranchez le courant avant de faire l'entretien.</p>
DC-2022		

DC-2022

Background: White
 Colors: Black, ANSI Yellow (Pantone 108C) and Safety Red (PMS 179C)
 Size: 5.000" x 3.000"

<p>⚠ CAUTION</p> <p>Airborne particles during operation. May impair vision and breathing. Do not enter when dryer is running.</p>		<p>⚠ ATTENTION</p> <p>Particules en suspension durant le fonctionnement. Peut affecter la vision et la respiration. Ne pas entrer quand le séchoir est en marche.</p>
DC-2023		

DC-2023

Background: White
 Colors: Safety Yellow (FFFF99) and Black
 Size: 9.000" x 3.000"

<p>⚠ WARNING</p> <p>High speed belt drive operating overhead. Can cause serious injury. Keep head and hands clear. Do not enter when dryer is running.</p>		<p>⚠ AVERTISSEMENT</p> <p>Poulie à courroie de haute vitesse au-dessus de la tête. Peut causer de sérieuses blessures. Gardez la tête et les mains éloignées. Ne pas entrer quand le séchoir est en marche.</p>
DC-2024		

DC-2024



Background: White
 Colors: Black, Safety Orange (PMS 152C) and Safety Yellow (PMS 109C)
 Size: 4.875" x 3.000"

<p>⚠ CAUTION</p> <p>Crush Hazard. Secure legs to foundation prior to opening doors. Serious injury could result.</p>		<p>⚠ ATTENTION</p> <p>Risque de se faire écraser. Stabilisez les jambes à la fondation avant d'ouvrir les portes. De sérieuses blessures peuvent se produire.</p>
DC-2026		

DC-2026

Background: White
 Colors: Safety Yellow (FFFF99) and Black
 Size: 9.000" x 3.000"

2. Decals

 WARNING		 AVERTISSEMENT
<p>SLIPS AND FALLS can cause severe injuries. Do NOT step or stand in this area.</p>		<p>GLISSER ET TOMBER peut causer de sérieuses blessures. Ne PAS enjamber ou se tenir debout dans cette zone.</p>
DC-2031		

DC-2031

Background: White
Colors: Black, Safety Orange (PMS 152C), Safety Red and Safety Yellow (FFFF99)
Size: 4.875" x 3.000"

 WARNING AVERTISSEMENT
<p>If an overload or a fault current interruption occurs, circuits must be checked to determine the cause of the interruption. If a fault condition exists, the current-carrying components should be examined and replaced if damaged, and the integral current sensors must be replaced to reduce the risk of fire or electric shock. Si une interruption de surcharge ou de courant fautif se produisent, les circuits doivent être vérifiés pour déterminer la cause de cette interruption. Si une condition fautive existe, les composants transportant le courant doivent être vérifiées et remplacées si endommagées. Les détecteurs de courant intégral doivent être remplacés pour réduire le risque de feu ou de choc électrique.</p>
DC-2033

DC-2033

Background: White
Colors: Black, Safety Orange (PMS 152C) and Safety Yellow (PMS 108C)
Size: 4.000" x 3.000"

 WARNING AVERTISSEMENT
<p>To maintain overcurrent short circuit and ground fault protection, the manufacturer's instructions for selecting overload relays and setting the instantaneous trip circuit breaker must be followed. Pour maintenir la protection de surcharge d'un court circuit ou de mise à la terre, les instructions du fabricant doivent être suivies en ce qui concerne la sélection des relais de surintensité et le positionnement du disjoncteur de déclenchement instantané.</p>
DC-2037

DC-2037

Background: White
Colors: Black, Safety Orange (PMS 152C) and Safety Yellow (PMS 108C)
Size: 3.000" x 2.500"

**WARNING
AVERTISSEMENT**

Insure that the incoming AC power and all separate power sources are turned off and locked before working on this equipment. Failure to observe this practice may result in severe injury, death, and/or equipment damage.

S'assurer que la puissance AC venant de l'extérieur et toutes autres sources de puissance indépendantes soient en arrêt et bloquées avant de travailler sur cet équipement. L'omission d'observer cette pratique peut résulter à des blessures sévères, la mort et/ou des dommages à l'équipement.

DC-2038

DC-2038

Background: White

Colors: Black, Safety Orange (PMS 152C) and Safety Yellow (PMS 108C)

Size: 3.000" x 3.000"

**WARNING
AVERTISSEMENT**

All maintenance procedures must be performed by qualified personnel who are familiar with the operation of this equipment. Failure to observe this warning can result in serious or even fatal injury and/or equipment damage.

Toutes les procédures d'entretien doivent être exécutées par un personnel qualifié étant familier avec le fonctionnement de cet équipement. L'omission d'observer cet avertissement peut résulter à des blessures sérieuses et même mortelles. Peut aussi causer des dommages à l'équipement.

DC-2039

DC-2039

Background: White

Colors: Black, Safety Orange (PMS 152C) and Safety Yellow (PMS 108C)

Size: 3.000" x 3.000"

Be sure that charge light and all LED's are out before touching any componenets.

Soyez assuré que la lumière de charge et toutes les LED soient fermés avant de toucher tout composants.

All test equipment should be connected and disconnected with power off.

Tout l'équipement de test devrait être branché et débranché quand tout est éteint.

Grounded test equipment, such as oscilloscopes, may damage the inverter.

L'équipement de test de mise à la terre, tel que les oscilloscopes, peut endommager l'onduleur de courant.

Isolate all instruments from ground before using. The DC bus remains charged for several minutes after power is removed.

Isoler tous les instruments au sol avant d'utiliser. Le DC bus reste chargé durant plusieurs minutes suivant la mise en arrêt de la puissance.

DC-2040

DC-2040

Background: White

Colors: Black and White

Size: 5.500" x 3.500"

**DANGER**

Rotating flighting will kill or dismember.
Les vols rotatifs causeront la mort ou démembrera.



Flowing material will trap and suffocate.
Le matériel flottant vous coïncera et causera la suffocation.



Crusted material will collapse and suffocate.
Le matériel croûté s'effondra et causera la suffocation.

Keep clear of all augers.
DO NOT ENTER this bin!

Restez éloigné de toutes les tarières.
NE PAS ENTRER dans ce silo!

If you must enter this bin:

Si vous devez entrer dans ce silo:

1. Shut off and lock out all power.
 2. Use a safety harness and safety line.
 3. Station another person outside the bin.
 4. Avoid the center of the bin.
 5. Wear proper breathing equipment or respirator.
1. Fermez et bloquez toutes la puissance de courant.
 2. Utilisez un harnais et une ligne de sécurité.
 3. Station another person outside the bin.
 4. Évitez le centre du silo.
 5. Portez un équipement de respiration ou un masque respiratoire approprié.

Failure to heed these warnings will result in serious injury or death.
L'omission de tenir compte de ces avertissements résultera à de sérieuses blessures ou la mort.

DC-2041

DC-2041

Background: White

Colors: Black, ANSI Yellow (Pantone 108C) and Safety Red (PMS 179C)

Size: 8.500" x 11.000"

3. Installation Requirements

Electrical

Standard voltages are:

1. 240, 480 or 575V, 60 Hz
2. 380-400V, 50 Hz

The power panel includes:

1. Main power disconnect.
2. Motor starters and overloads. (Standard direct on line, star/delta and soft start are options.)
3. Control circuit breakers for the individual blower motors.
4. Auxiliary 7.5 kW motor starters for dry and wet grain handling equipment.
5. A correctly designed power supply is required, including safety earth connection.

Tower Dryer Power Requirements

		3 Phase Power Requirements (A)						
Supply Voltage		230	380	400	415	440	460	575
Model #								
Z-1210		218	132	125	121	114	109	87
Z-1512		250	151	144	138	131	125	100
Z-1816		250	151	144	138	131	125	100
Z-2018		308	186	177	171	161	154	123
Z-2420		308	186	177	171	161	154	123
Z-2521		361	219	208	200	189	181	144
Z-3026		433	262	249	240	226	217	173
Z-3531		499	302	287	277	261	250	200
Z-4036		595	360	342	330	311	298	238
Z-4742		595	360	342	330	311	298	238
Z-5046		771	466	443	427	403	385	308
Z-6055		771	466	443	427	403	385	308
Z-7060		945	571	543	523	494	472	378
Z-10090		1235	747	710	684	646	618	494
T-1050		204	123	117	113	106	102	81
T-1260		226	136	130	125	118	113	90
T-1575		258	156	148	143	135	129	103

Tower Dryer Power Requirements (Continued)

Supply Voltage	3 Phase Power Requirements (A)						
	230	380	400	415	440	460	575
Model #							
T-1875	258	156	148	143	135	129	103
T-20100	316	191	181	175	165	158	126
T-24100	316	191	181	175	165	158	126
F-1050	204	123	117	113	106	102	81
F-1260	226	136	130	125	118	113	90
F-1575	258	156	148	143	135	129	103
F-1875	258	156	148	143	135	129	103
F-20100	316	191	181	175	165	158	126
F-24100	316	191	181	175	165	158	126
G-1200	228	138	131	126	119	114	91
G-1500	260	157	150	144	136	130	104
G-1800	260	157	150	144	136	130	104
G-2000	318	192	183	176	166	159	127
G-2400	318	192	183	176	166	159	127
G-2500	370	224	213	205	193	185	148
G-3000	442	267	254	245	231	221	177
G-3500	508	307	292	281	266	254	203
G-4000	604	365	347	335	316	302	242
G-4718	604	365	347	335	316	302	242
G-5000	778	471	447	431	407	389	311
G-6000	778	471	447	431	407	389	311
G-7000	952	576	547	527	498	476	381
G-10000	1240	750	713	687	648	620	496

Fuel

- Fuel types are propane or natural gas vapor.
- Minimum supply pressure is,
 - 450 mBar natural gas at full burner flow rate.
 - 700 mBar propane vapor at full burner flow rate.
- Burner flow rates are as shown [on Page 14](#). Liquid propane vaporization is either in tank or via external vaporizer.

3. Installation Requirements

Dryer Fuel Specification and Commissioning Set Points

T and F Series	T/F-1260	T/F-1575	T/F-1875	T/F-1054	T/F-20100	T/F-24100								
Zimmerman	Z-1210	Z-1512	Z-1816	Z-2018	Z-2420	Z-2521	Z-3026	Z-3531	Z-4036	Z-4742	Z-5046	Z-6055	Z-7060	Z-10090
GSI	G-1200	G-1500	G-1800	G-2000	G-2400	G-2500	G-3000	G-3500	G-4000	G-4718	G-5000	G-6000	G-7000	G-10000
Max. Burner Output (kW)	3831	4882	5180	6244	6858	7722	9195	11133	12206	13526	17628	19301	21372	31662
Average Burner Output (kW)	2203	2807	2979	3590	3943	4440	5287	6401	7018	7777	10268	11098	12289	18206
LPG Fuel		LPG Gross CV		93.8 MJ/m³										
Max. Gas Flow LPG (m ³ /h)	147	187	199	240	263	296	353	427	468	519	677	741	820	1215
Average Gas Flow LPG (m ³ /h)	85	108	114	138	151	170	203	246	269	298	394	426	472	699
Supply Pressure mBar ¹	350-700	350-700	350-700	350-700	350-700	350-700	350-700	350-700	350-700	350-700	350-700	350-700	350-700	350-700
Regulator Setting mBar ²	206	206	206	206	206	206	206	206	206	206	206	206	206	206
Regulator Spring	Cadmium	Cadmium	Cadmium	Cadmium	Cadmium	Cadmium	Cadmium	Cadmium	Cadmium	Cadmium	Cadmium	Cadmium	Cadmium	Cadmium
Burner Pressure High-Fire mm H ₂ O ⁶	418	1375	807	1189	1447	972	1387	1418	1962	1931	1452	1098	751	1525
Burner Pressure Low-Fire mm H ₂ O ⁷	16.7	55.0	32.3	47.5	57.9	38.9	55.5	56.7	78.5	77.3	58.1	43.9	30.1	61.0
Pilot Pressure mm/H ₂ O ³	400	400	400	400	400	400	400	400	400	400	400	400	400	400
Natural Gas Fuel		NG Gross CV		39 MJ/m³										
Max. Gas Flow NG (m ³ /h)	357	455	483	582	640	720	858	1038	1138	1262	1644	1800	1993	
Average Gas Flow NG (m ³ /h)	205	262	278	335	368	414	493	597	655	725	958	1035	1146	
Supply Pressure mBar ¹	350-700	350-700	350-700	350-700	350-700	350-700	350-700	350-700	350-700	350-700	350-700	350-700	350-700	
Regulator Setting mBar ²	206	206	206	206	206	206	206	206	206	206	206	206	206	
Regulator Spring	Cadmium	Cadmium	Cadmium	Cadmium	Cadmium	Cadmium	Cadmium	Cadmium	Cadmium	Cadmium	Cadmium	Cadmium	Cadmium	
Burner Pressure High-Fire mm H ₂ O ⁶	719	1189	697	1009	1241	855	1214	1210	1365	1675	1267	963	633	
Burner Pressure Low-Fire mm H ₂ O ⁷	28.8	47.6	27.9	40.3	49.7	34.2	48.6	48.4	54.6	67.0	50.7	38.5	25.3	
Pilot Pressure mm/H ₂ O ³	400	400	400	400	400	400	400	400	400	400	400	400	400	

1. Pressure from supply read at inlet gauge. (Ref # 7 on Figure 3B on Page 16.)
2. Pressure after regulator read at sensing line gauge. (Ref # 25 on Figure 3B on Page 16.)
3. Pressure set with pilot flow adjuster on pilot valve (Ref # 37 on Figure 3B on Page 16) read at pilot gauge (Ref # 41 on Figure 3B on Page 16).
4. Relief valve. (Ref # 24 on Figure 3B on Page 16.)
5. OPSO valve. (Ref # 30 on Figure 3B on Page 16.)
6. Burner pressure with modulating valve at maximum read at burner pressure gauge. (Ref # 56 on Figure 3B on Page 16.)
7. Burner pressure with modulating valve at minimum read at burner pressure gauge. (Ref # 56 on Figure 3B on Page 16.)

2" CE Tower Dryer Pipe Train Assembly

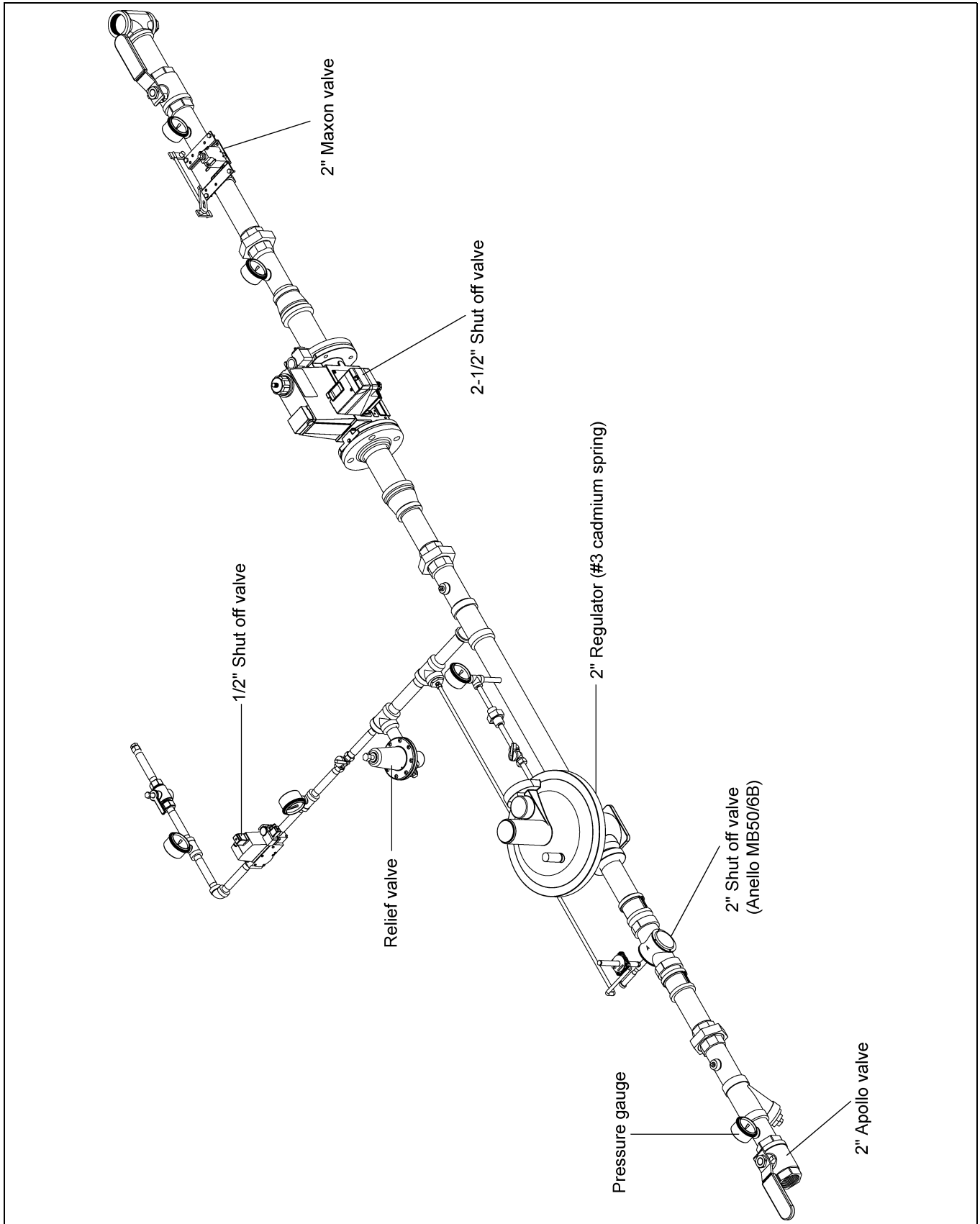

Figure 3A Dryer Pipe Train

2" CE Tower Dryer Pipe Train Assembly (Continued)

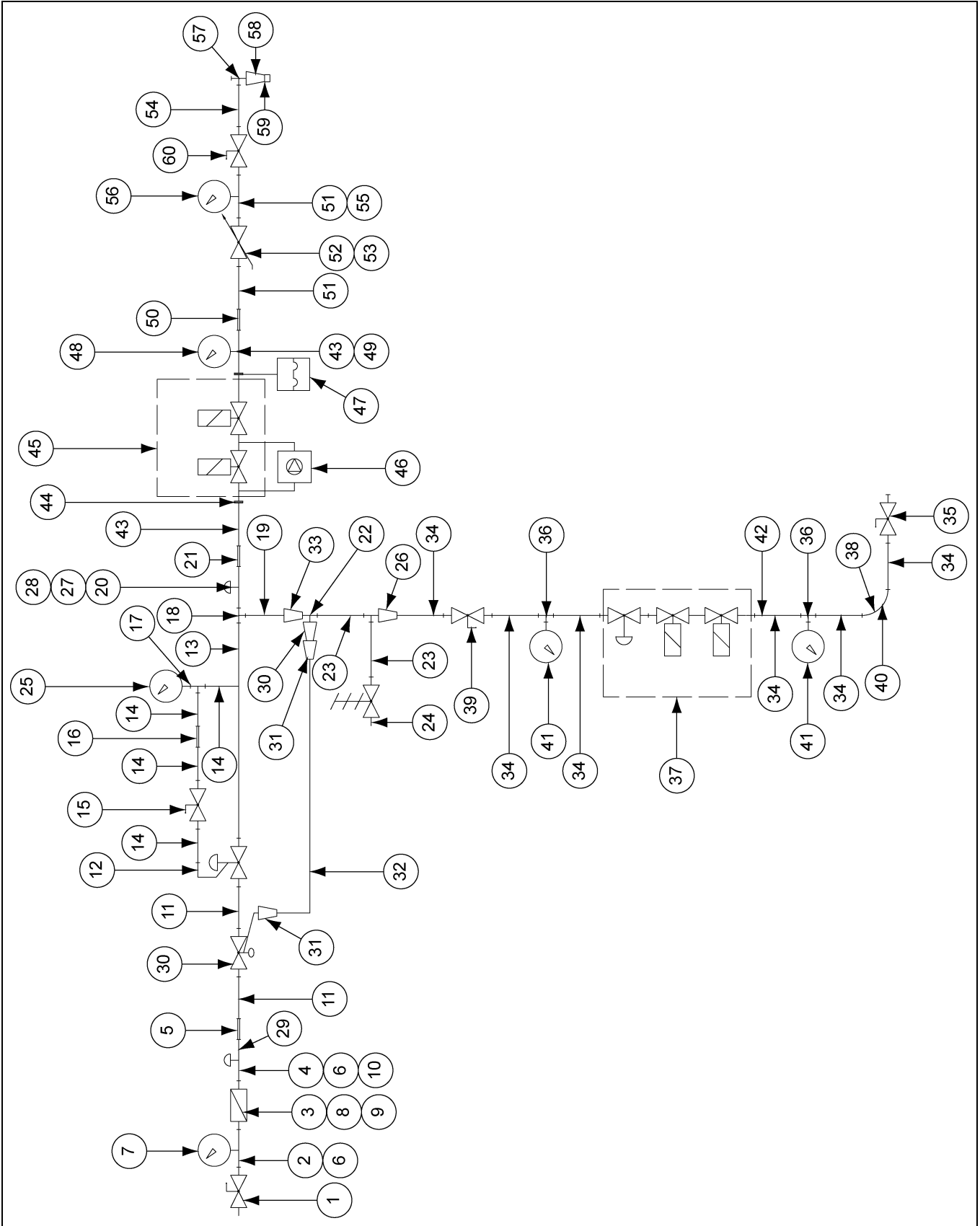

Figure 3B Dryer Pipe Train

2" Shut Off Section Tower Dryer (GT4-0046CE) Parts List

Ref #	Part #	Description	Qty
1	GT3-0014	Valve, Ball Manual, 2"	1
2	GT3-0019	Nipple, 2" x 4" SCH 40 Black	2
3	GT3-0013	Strainer, 2" "Y" #11 W/3/64 Perf 2" Includes 1" Reducer	1
4	GT3-0020	Nipple, 2" x 6" SCH 40 Black	1
5	GT3-0032	Union, 2" SCH 40 Black	1
6	GT3-1165	Anvilet, 1/4" NPT	1
7	D03-0867	Gauge, PSI 0-15 Dual Scale 0-100 kPa Liquid Filled	1
8	GT3-0261	Reducer, Hex 2" x 1" Black	1
9	D08-0014	Plug, 1" Square Black	1
10	007-1747-0	Plug, Pipe 1/4" NPT	1

2" Regulator Section Tower Dryer (GT4-0203CE) Parts List

Ref #	Part #	Description	Qty
11	GT3-0020	Nipple, 2" x 6" SCH 40 Black	2
12	GT3-0471	Regulator, Gas Equimeter, 2" (#3 Cadmium Spring))	1
13	GT2-0116	Nipple, 2" x 24" SCH 40 Black	1
14	GT3-0017	Nipple, 1/4" x 4" SCH 40 Black	4
15	D02-0084	Valve, 1/4" NPT Brass Ball 707-1143-7	1
16	GT3-0205	Union, 1/4" Black	1
17	707-1689-9	Tee, 1/4" Black SCH 80	1
18	D03-0443	Tee, 2" x 2" x 1" SCH 40 Black	1
19	THH-4116	Nipple, 1" x 6" SCH 40 Black	1
20	GT3-0020	Nipple, 2" x 6" SCH 40 Black	1
21	GT3-0382	Union, 2" SCH 80 Black	1
22	THH-4124	Tee, 3/4" x 3/4" x 3/4" SCH 40 Black	2
23	No Part #	Nipple, 3/4" x 4" SCH 40 Black	2
24	No Part #	Pressure Relief 3/4" mBar	1
25	D03-0867	Gauge, PSI 0-15 Dual Scale 0-100 kPa Liquid Filled	1
26	No Part #	Reducer, Hex 3/4" x 1/2" SCH 40 Black	1
27	GT3-1165	Anvilet, 1/4" NPT	1
28	007-1747-0	Plug, Pipe 1/4" NPT	1
29	No Part #	Anello MB50/6B OPSO with Neutral Spring	1
30	No Part #	Reducer, Hex 3/4" x 1/8" NPT SCH 40 Black	1
31	GT3-0110	Fitting, 3/8" CMP x 1/8" MPT Brass	2
32	GT3-0065	Tube, Copper 3/8" O.D.	4'
33	No Part #	Reducer, Hex 1" x 3/4" SCH 40 Black	1

3. Installation Requirements

1/2" Pilot Section Tower Dryer (GT4-0202CE) Parts List

Ref #	Part #	Description	Qty
34	THH-4129	Nipple, 1/2" x 5" SCH 40 Black	5
35	TFC-0026	Valve, 1/2" NPT Firing - CGA	1
36	HH-4846	Tee, 1/2" x 1/2" x 1/4" SCH 80 Black	2
37	No Part #	Valve, Dungs MBC-65-DLE-S40/S42 Combination Double Valve and Regulator 1/2" 120 VAC	1
38	HH-4847	Elbow, 1/2"-90° SCH 80 Black	1
39	D03-0937	Valve, 1/2" NPT Brass Ball	1
40	HH-7053	Elbow, 1/4"-90° SCH 80 Black	1
41	No Part #	Gauge, Gas 0-500 mBar	2
42	007-1747-0	Plug, Pipe 1/4" NPT	1

2" SSOV Section Tower Dryer (GT4-0205CE) Parts List

Ref #	Part #	Description	Qty
43	GT3-0020	Nipple, 2" x 6" SCH 60 Black	2
44	No Part #	DN65 Flange with 2" NPT Female Thread or Stub	2
45	No Part #	Valve, Dungs DMV-DL-5065/11 120 VAC	1
46	TF-1892	Valve, Proving System Dungs CE Dungs Model# VPS 504 S04	1
47	TF-1893	Switch, CE High Pressure Dungs, Dungs Model# GW 500 A2 HGPS	1
48	No Part #	Gauge, Gas 0-500 mBar	1
49	GT3-1165	Anvilet, 1/4" NPT	1
50	GT3-0032	Union, 2" SCH 40 Black	1

2" Modulator Section Tower Dryer (GT4-0204CE) Parts List

Ref #	Part #	Description	Qty
51	007-1469-1	Nipple, 2" x 8"	2
52	GT3-0515	Valve, Maxon 2" CV Series #63-18209	1
53	GT3-1151	Switch, Maxon 2" CV Low-Fire #1036373	1
54	GT3-0020	Nipple, 2" x 6" SCH 40 Black	1
55	GT3-1165	Anvilet, 1/4" NPT	1
56	No Part #	Gauge, Gas 0-500 mBar	1
57	GT3-0025	Tee, 2" SCH 40 Black	1
58	GT3-0261	Reducer, Hex 2" x 1" Black	1
59	D08-0014	Plug, 1" Square Black	1
60	GT3-0014	Valve, Ball Manual, 2"	1

PLC Dryer Control Panel

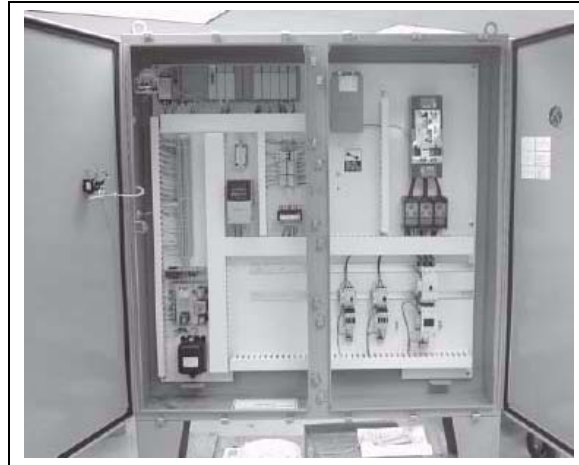

Figure 3C PLC Dryer Control Panel

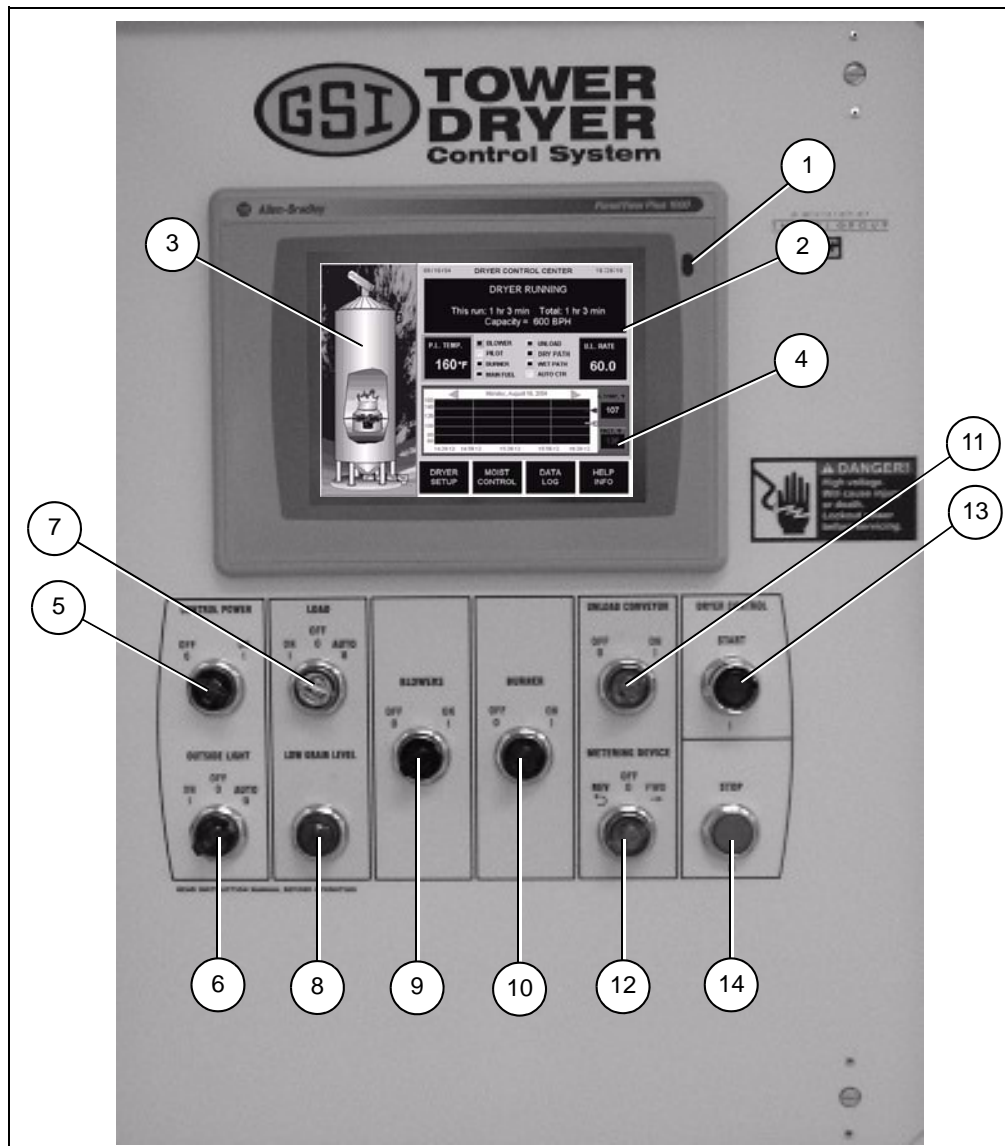

Figure 3D PLC Control Screen

3. Installation Requirements

1. **Display** provides visual feedback and touch screen control.
2. **Message Center** displays current dryer conditions and alarm messages and troubleshooting.
3. **Dryer View** provides indication of dryer functions and access to burner and grain flow status screens.
4. **Temperature/Moisture History Chart** records up to 32 hours of dryer temperature and/or moisture data.
5. **Control Power switch** allow 60 seconds for start-up.
6. **Outside Light switch** ON/OFF/AUTO.
7. **Load switch** controls dryer filling ON/OFF/AUTO.
 'On demand' filled dryers (conveyor or slide gate):
 - a. ON or AUTO - Fill system starts/opens or stops/closes according to grain level.
 - b. AUTO - As above plus dryer shuts down on low grain after the OUT OF GRAIN TIMER expires. 'Choke' filled dryers:
 - a. AUTO - Dryer shuts down on low grain after the OUT OF GRAIN TIMER expires.
 - b. ON or OFF - OUT OF GRAIN TIMER is disabled, the LOAD switch illuminates when load system is powered.
8. **Low Grain Light** -
 - a. Flashes when grain level is low before shut down.
 - b. Continuous after low grain shut down.
9. **Blowers switch** - Controls blowers.
 - a. Blowers start sequentially.
 - b. Switch flashes during blower start-up
 - c. Continuous when air switch closes.
10. **Burner switch** - Controls burner. When ON,
 - a. Valve proving system checks valves.
 - b. Burner control checks air switch function.
 - c. Modulating valve drives to low-fire position.
 - d. 35 Second purge.
 - e. Pilot light ignition.
 - f. Main burner automatic ignition.

11. **Unload Conveyor switch** - Continuous light when unload is running.
12. **Metering Device switch** - Controls metering system (forward/off/reverse).
 - a. Unload conveyor must be ON.
 - b. Illuminates when system runs.
13. **Dryer Power Start button** initiates operation of the dryer.
14. **Dryer Power Stop button** -
 - a. Stops all dryer functions and automatic equipment in a controlled shut down sequence.
 - b. Also effects a reset after automatic shut down.

4. Dryer Commissioning

Electrical

1. Carry out earth bonding test per EN60204 and local electrical laws and regulations.
2. Check adequate power supply. (Refer to table [on Pages 12 and 13.](#))
3. Voltage at phases must be within 5% of rated voltage.
4. Voltage drop must not exceed 5% when under full load.
5. Check overload settings for each motor circuit.
6. Complete full electrical tests in accordance with EU Directives and local laws, regulations and codes.

Gas Train

1. Pressure test
 - a. Close inlet valve. (Ref # 1 [on Figure 3B on Page 16.](#))
 - b. Close firing valve. (Ref # 60 [on Figure 3B on Page 16.](#))
 - c. Close pilot line valve. (Ref # 35 [on Figure 3B on Page 16.](#))
 - d. Fit pressure test nipple into main solenoid inlet flange.
 - e. Attach hand bellows and pressure gauge.
 - f. Pressures gas train with air to 35 kPa (350 mBar).
 - g. Check from pressure loss at gauge.
 - h. Use leak detection to test for leaks.
 - i. Repeat on outlet flange.
 - j. Repeat on pilot line.
2. Set inlet pressure per table [on Page 14.](#)
3. Set relief valve per table [on Page 14.](#)
 - a. Apply air pressure via main solenoid inlet flange.
 - b. Increase/decrease spring pressure in relief valve.
 - c. Valve should open at 50 kPa maximum.
4. Set over pressure shut off (OPSO) per table [on Page 14.](#)
 - a. Apply air pressure via main solenoid inlet flange.
 - b. Increase/decrease spring pressure in OPSO.
 - c. Valve should shut open at 45 kPa maximum.
5. Set operational pressure per table [on Page 14.](#)
 - a. Open main gas valve.
 - b. Adjust pressure at regulator.

6. Set pilot flow rate (must be done with pilot alight).
 - a. Open pilot valve. (Ref # 35 [on Figure 3B on Page 16.](#))
 - b. Disconnect solenoid connection on main valves.
 - c. Start blowers.
 - d. Start burners.
 - e. When pilot solenoid valve opens, adjust flow rate to give required pilot pressure per table [on Page 14.](#)
 - f. Adjustment is on pilot solenoid valve. ([See Figure 4A.](#))

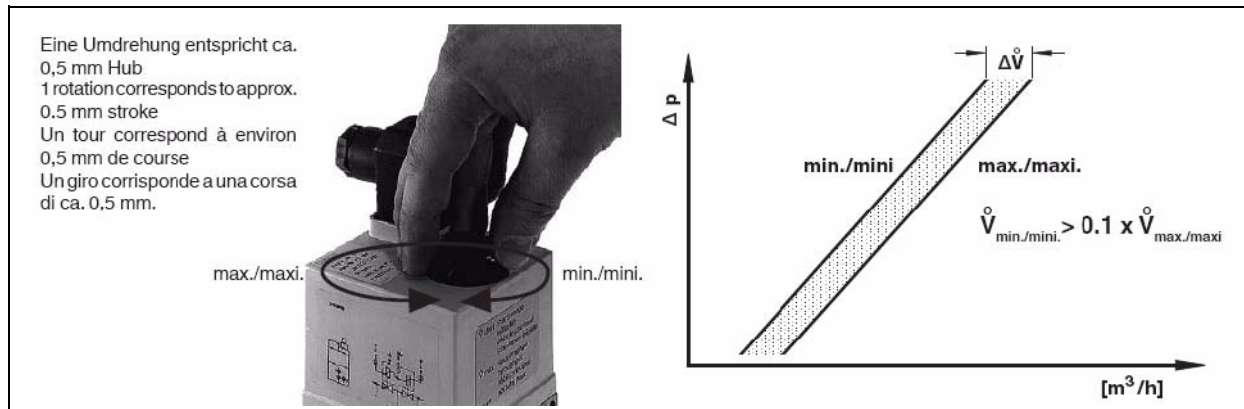

Figure 4A Pilot Valve Flow adjustment

7. Set burner high-fire pressure.
 - a. Re-connect main solenoid valves.
 - b. Note required high-fire pressure from table [on Page 14.](#)
 - c. Set plenum temperature to approximately 200°F above ambient.
 - d. Light burners.
 - e. Check modulating valve has driven fully open.
 - f. Read pressure at burner gauge. (Ref # 56 [on Figure 3B on Page 16.](#))
 - g. Adjust pressure a regulator to give required pressure.
 - h. Lock regulator.
8. Set burner low fire pressure.
 - a. Set plenum temperature to approximately 10°F above ambient.
 - b. Light burners.
 - c. On low-fire, adjust modulating valve minimum setting to give pressure as per table [on Page 14.](#)
 - d. Read pressure at burner gauge. (Ref # 56 [on Figure 3B on Page 16.](#))
9. Run burners and check burner modulates correctly.
10. Check gas pressure remains stable.
11. Fill out gas train commissioning check sheet.

5. Dryer Operation

Start-Up



Complete pre-season inspection and service as per maintenance section on Page 35.



Close all discharge, clean out, cooling, grain exchange and heat section doors.



Make sure that all personnel are clear of the dryer and associated machinery.

1. Open main gas valve.
2. Switch ON electrical power (main disconnect to ON).
3. Check Emergency Stop buttons are fully out.
4. Switch on CONTROL POWER. Wait whilst control boots up.
5. Press Start on touch screen.
6. Press Dryer Power Start button.
7. Start auxiliary fill equipment.
8. Turn LOAD selector switch to ON. Dryer should start filling.
9. When the horn sounds (dryer full), turn the LOAD selector switch to the AUTO position to silence the alarm and begin normal dryer operation.
10. Set plenum temperature by touching the "P.L. Temp" box on the LCD display. Enter drying temperature.

Recommended drying temperatures,

- a. Corn 180°F to 210°F
 - b. Soybeans 140°F to 160°F
 - c. Wheat 140°F to 160°F
 - d. Milo 160°F to 180°F
 - e. Barley 140°F to 160°F
 - f. Oats 140°F to 160°F
11. Turn **BLOWERS** selector switch to **ON**.

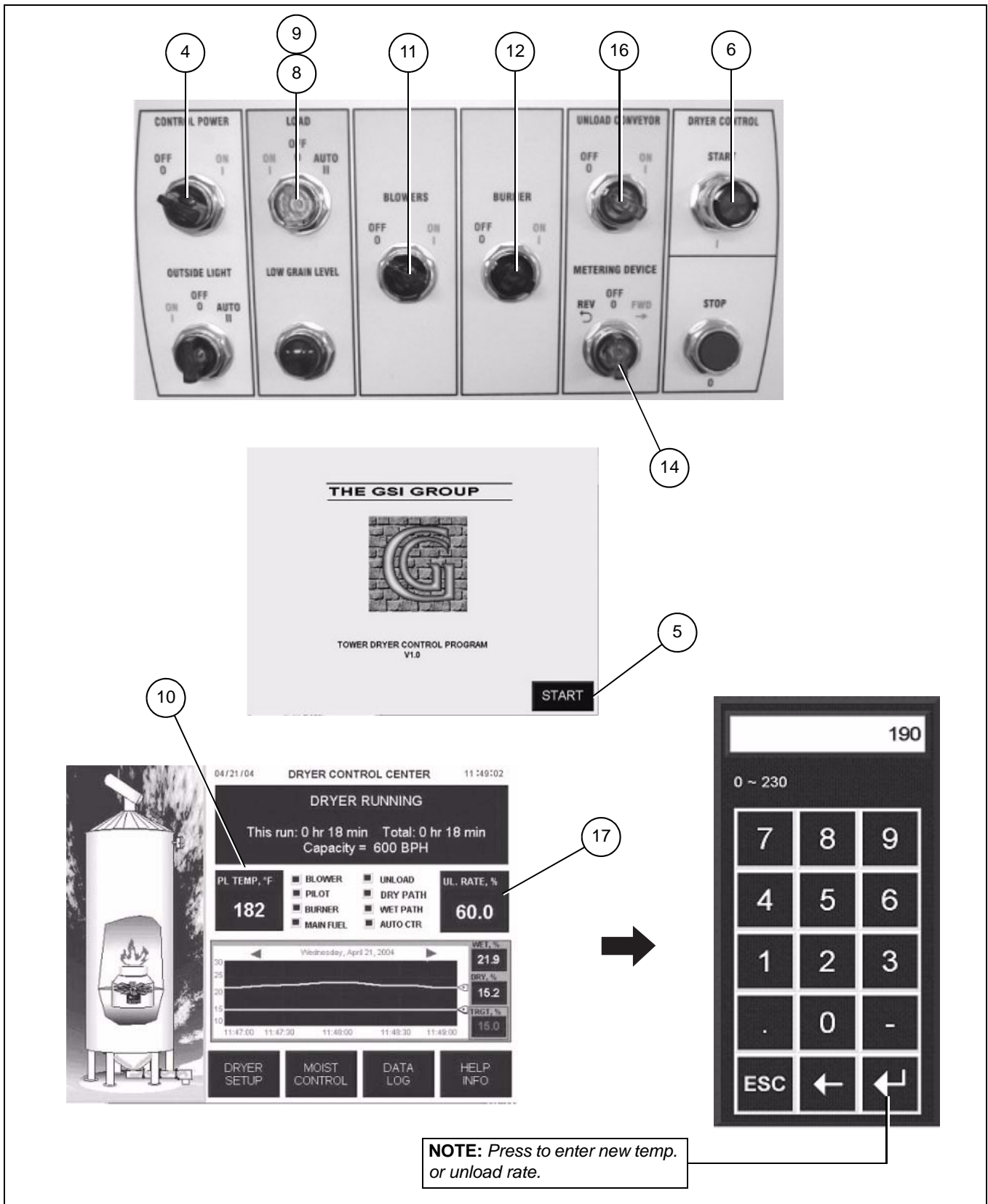

Figure 5A

5. Dryer Operation

12. **Start the burner.** Turn BURNER selector switch to the “ON” position.
 - a. Burner will purge for 30 seconds.
 - b. Pilot will automatically light.
 - c. If the pilot fails to light in 4 seconds the burner will lock out and must be re-set. Turn BURNER switch “OFF” then back “ON”.
13. Once pilot is established the main burner will automatically light in low flame.
14. The dryer’s plenum temperature will be automatically controlled at the selected temperature.
15. **Let plenum come up to temperature and begin drying.** Depending upon ambient conditions, the dryer may take 10 minutes or more to reach the drying temperature.
16. **Start unload system.** Check that elevators and conveyors are all running dryer. Turn the UNLOAD CONVEYOR switch to ON.

Turn the METERING DEVICE switch to “FORWARD”. Grain should now start discharging.
17. **Set Unload Rate/Moisture Control Temperature.** While operating the dryer in MANUAL mode, set the unload rate by touching the “U.L. Rate” box on the screen. On the keypad, enter the new unload rate and press return.
18. Check discharge moisture content after 10 minutes. Take five (5) small samples from the discharge and mix before taking a moisture reading.
19. When the discharge moisture content has stabilized for 20 to 30 minutes switch to Automatic Moisture Control.
 - a. Press the MOISTURE CONTROL on the screen.
 - b. On the Moisture Control Setup screen, set the upper and lower limits by touching the corresponding box and using the pop-up keypad. These values prevent the unload from moving too fast or too slow should the incoming moisture be significantly greater or less than anticipated.
 - c. Press the CONTROL MODE box to toggle between Manual and Automatic moisture control. Note that the current and target grain temperatures are displayed next to the Temperature History Chart.

NOTICE

If the discharge moisture content is consistently too high or too low, adjust the target grain temperature as follows:

5°F increases - 1 moisture point decrease

5°F decrease - 1 moisture point increases

Allow 30 minutes between adjustments.

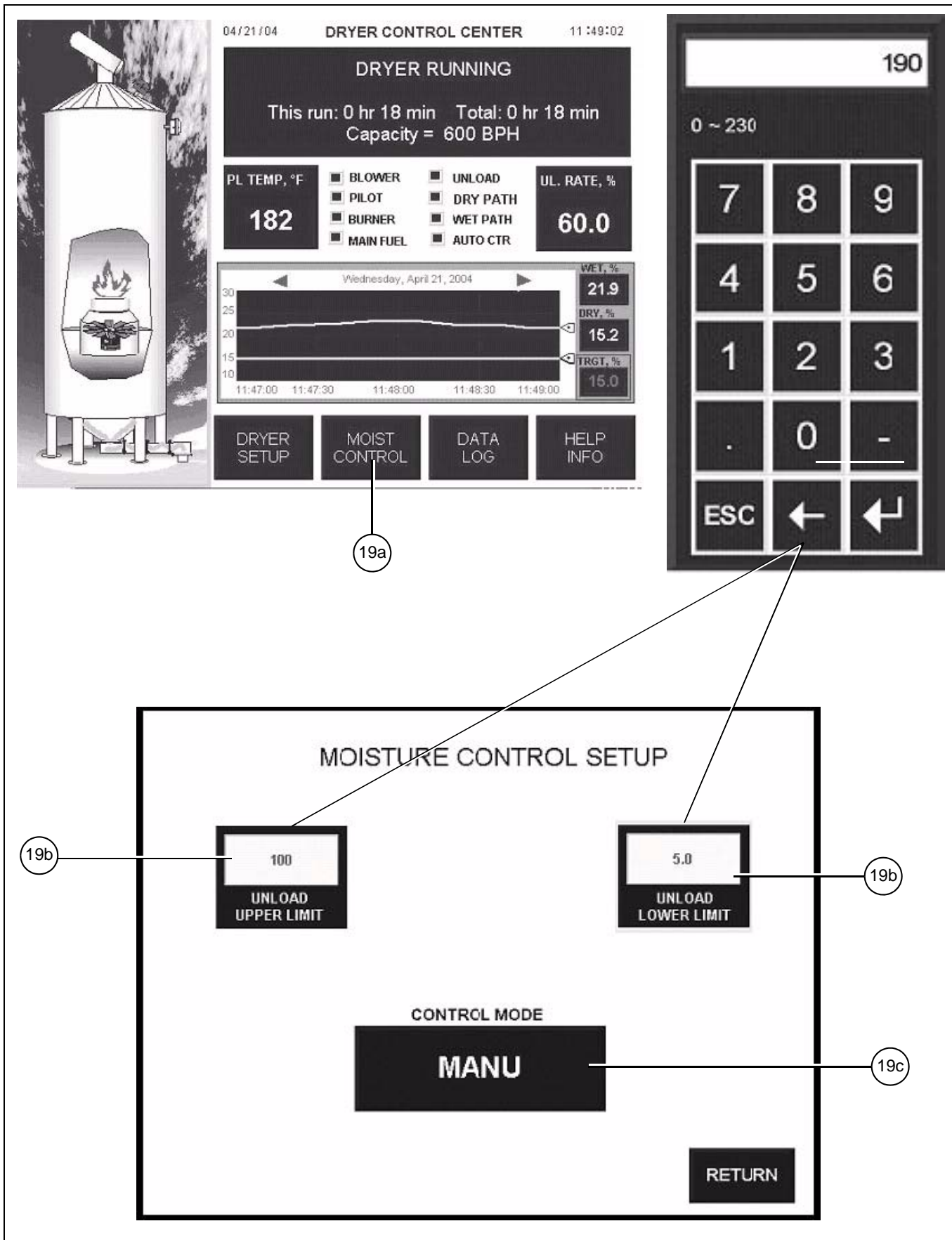

Figure 5B

5. Dryer Operation

Shut Down

1. Short shut downs - **Less than 4 hours**
 - a. Press Dryer Power Stop button.
 - b. Press Dryer Power Start to re-starting. The PLC will restart the dryer automatically based on selector switch settings.
2. Extended shut downs - **4 hours or more**
 - a. **Shut off the burner.** Turn the BURNER switch to “OFF”.
 - b. **Cool down grain.** Blowers will continue to cool grain. Keep unloading during cool down to avoid overdrying grain.
 - c. **Shut off unload equipment.** Turn METERING DEVICE and UNLOAD CONVEYOR switches to “OFF”.
 - d. **Shut off blowers.** Turn BLOWER switch to “OFF”.
 - e. **Shut off control panel.** Turn the CONTROL POWER switch to “OFF”.
 - f. **Turn OFF main power.**
 - g. **Close manual gas valve.**
 - h. **Inspect the inside of the dryer** after operation to insure against the possibility of hot spots or fires.

Viewing Temperature/Moisture History

Scroll left and right in the Temperature/Moisture History chart using left and right arrows.

Viewing Burner/Fuel Train Status

Press the Burner region in the Dryer View on the screen to view status of all valves as well as the modulating valve position.

Viewing Grain Flow Status

Press the Unload region in the Dryer View on the screen to view the status of all controlled/interlocked equipment in the grain flow path.

Modifying the Bushel Per Hour Factor

To get a true throughput reading, the correction factor may need to be calibrated.

By default the factor is 1.0.

Calculate the percentage difference between the dryer reading as follows:

$$\% \text{ Difference} = \frac{(\text{Actual} - \text{Reading}) \times 100}{\text{Reading}}$$

% Difference	Calibration Factor
+25%	1.25
+20%	1.20
+15%	1.15
+10%	1.10
+5%	1.05
0%	1.00
-5%	0.95
-10%	0.90
-15%	0.85
-20%	0.80
-25%	0.75

Interpolate and extrapolate for differences not given.

To adjust the correction factor, press DRYER SETUP then the BUSHEL COUNTER button then CORRECTION FACTOR box to adjust the value.

6. Tri-Point Moisture Controller

Control Operation Principles

The controller continuously monitors incoming and outgoing moisture as well as grain temperature at the end of the drying section. The control action is mainly based on the dry sensor at the outlet of the dryer. If the moisture coming out of the dryer is not right at the target, the controller will speed up or slow down the unload device accordingly. The wet sensor and the column grain temperature sensor are intended to detect moisture spikes coming into the dryer so that the moisture controller can react ahead of time. For example, if the wet sensor detects a jump of moisture coming into the dryer, the controller will start slowing down the unload speed right away. However, the controller does not act to the full scale immediately. Instead, it slows down the dryer gradually so that the grain currently in the dryer will not be over-dried too much.

In the first pass after the dryer started, the controller does not have enough information of the grain in the dryer. It controls the dryer by using the manual speed setting as a starting point. In other words, the manual speed setting is most responsible for the first pass of drying. Therefore, set the manual unloading speed as close as it should be for the grain currently in the dryer before switching to **AUTO** control mode. The manual speed setting does not have to be adjusted after the controller is switched into **AUTO** mode.

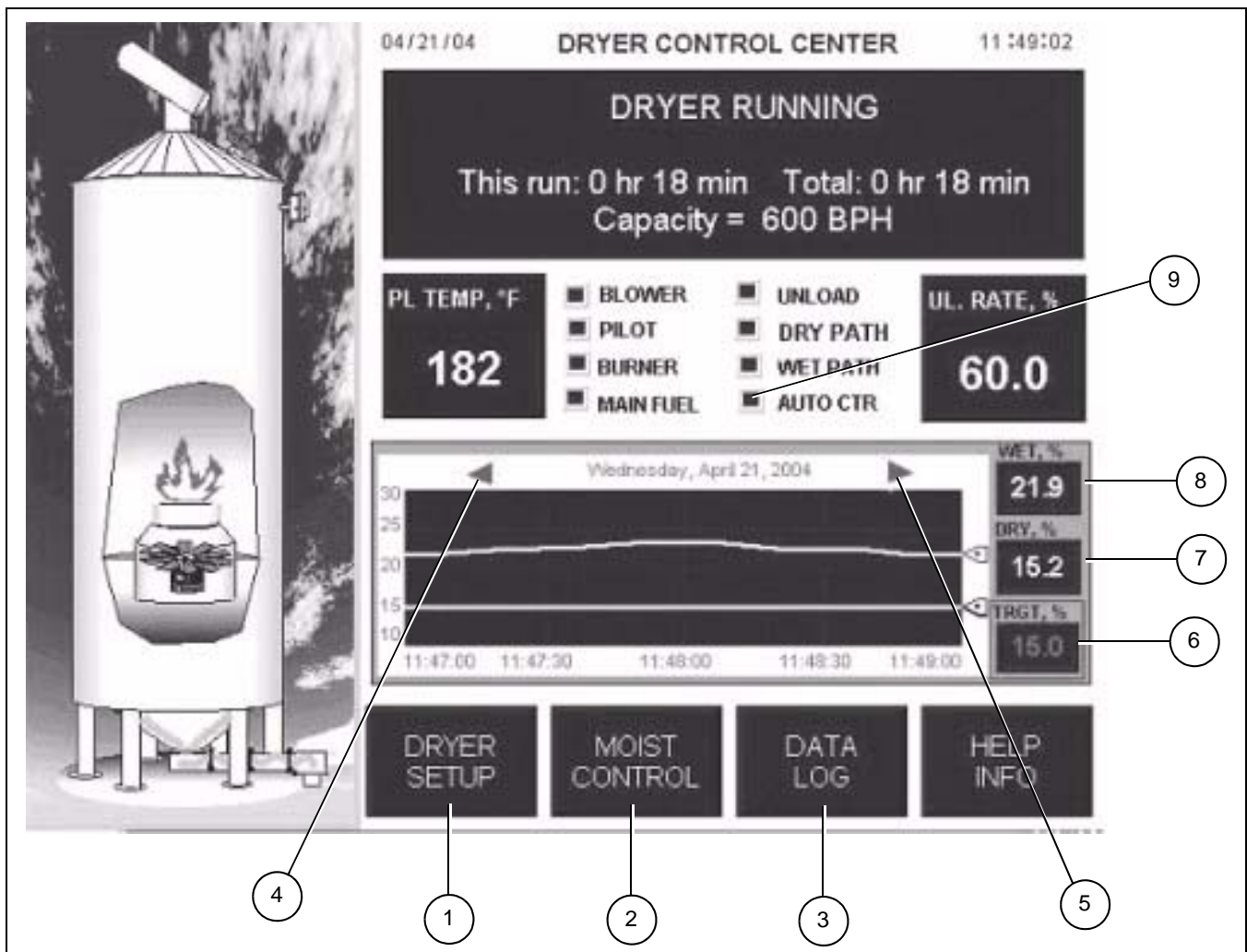

Figure 6A

1. **Moisture history chart.** View dryer history.
2. **Moisture Control button.** Set moisture control.
3. **Data Log button.** Access dryer history.
4. **Scroll Back button.**
5. **Scroll Forward button.**
6. **Target moisture.** Set required moisture.
7. **Current outgoing moisture.**
8. **Current incoming moisture.**
9. **Moisture control status.** On = Auto

Set-Up Controller

1. Press the “MOIST CONTROL” button from the main screen to access the moisture set-up.

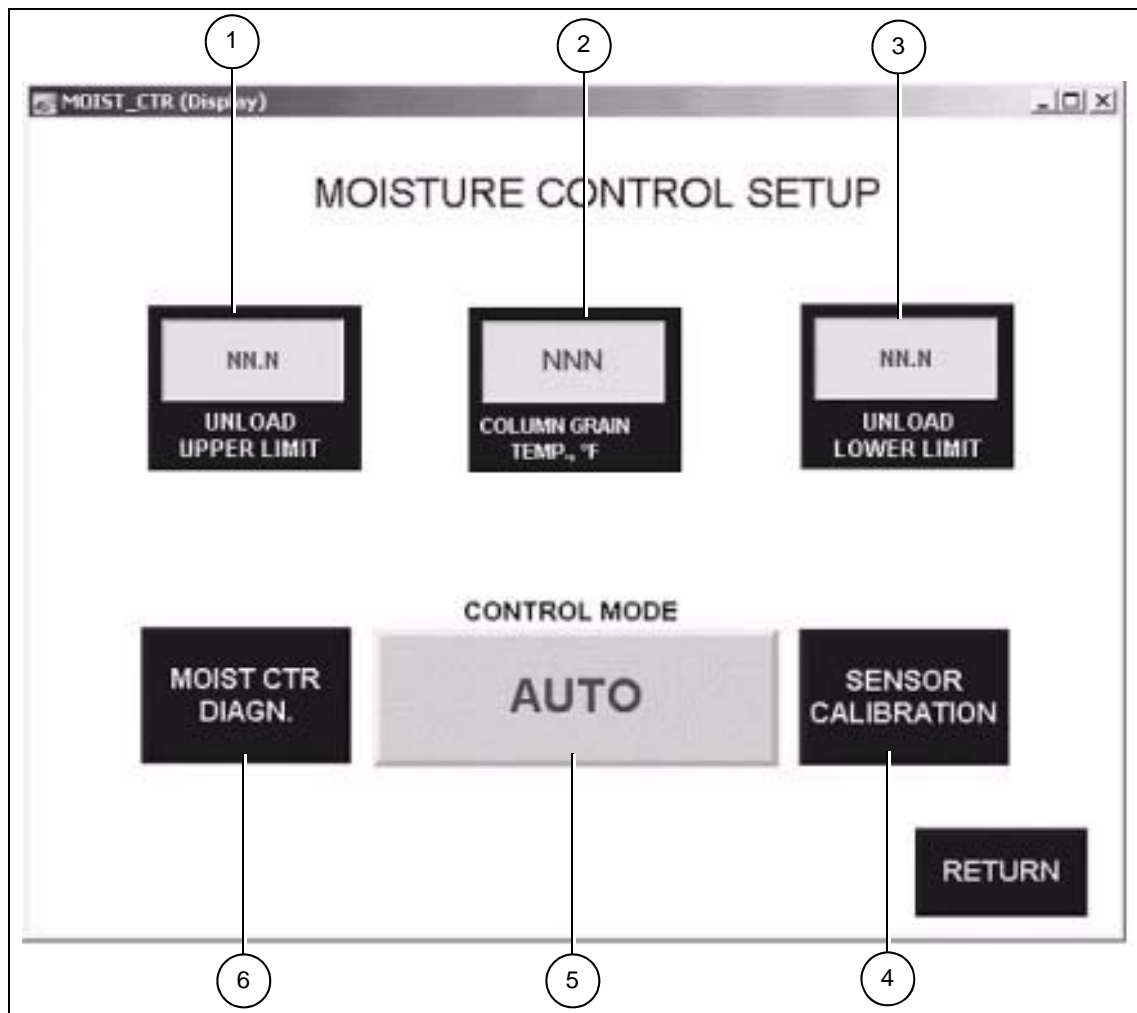

Figure 6B

6. Tri-Point Moisture Controller

1. **Unload upper limit** - Set maximum unload limit for the handling equipment.
2. **Current column grain temperature** - From the end of the drying section.
3. **Unload lower limit** - Set minimum unloading speed to keep moisture sampler covered with grain.
4. **Calibration button** - To calibrate moisture sensor.
5. **Control Mode button** - To toggle between AUTO and MANUAL.
6. **Moisture Control Diagnosis button** - To allow diagnostics.

Operation Procedure

1. Start the dryer and set dryer unload at the required speed.
2. Let the dryer run in manual until the column grain temperature has stabilized and the outgoing moisture is $\pm 2\%$ of the target moisture.
3. Calibrate wet and dry sensors against an accurate moisture meter.
 - a. Press "SENSOR CALIBRATION" in the moisture control set-up screen.
 - b. Adjust the moisture sensor offset to compensate for differences between the average sample reading and the on-screen reading.
 - c. Example: If the dryer is reading 15.0% and the average sample is 14.0%, alter the offset to -1.0%.

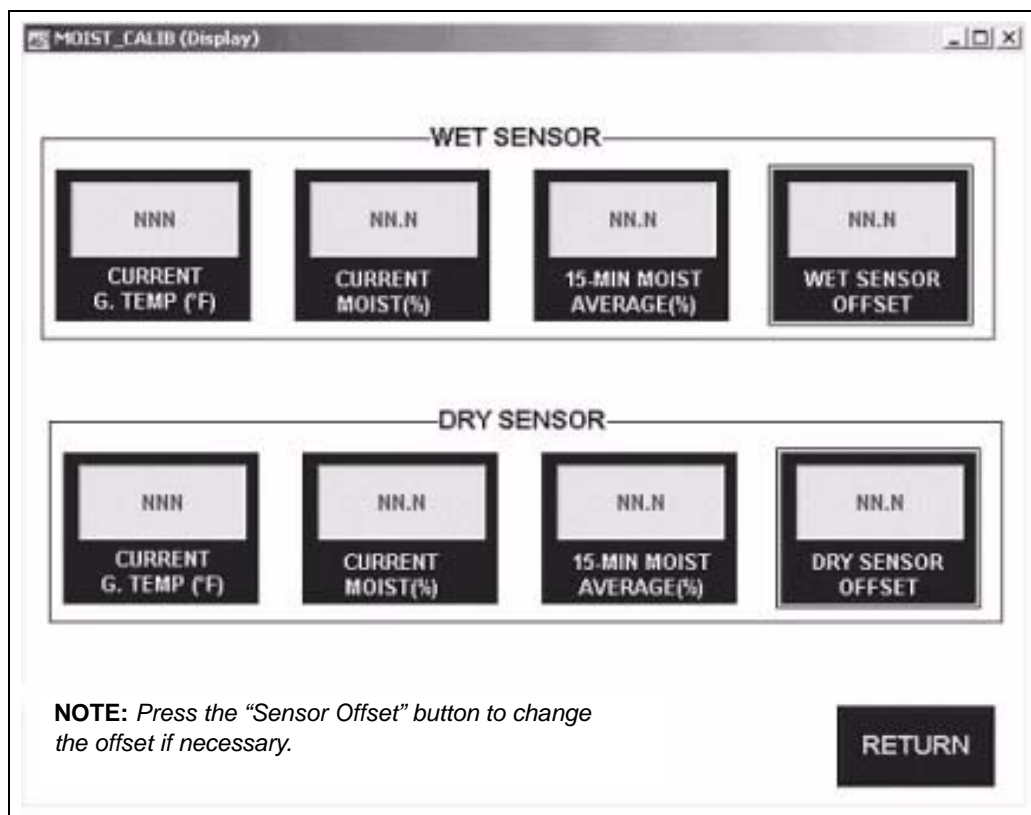

Figure 6C

- d. Calibrate three (3) times per day.
 - e. Clean the sensor regularly.
 - f. Grain must flow freely over the sensor.
4. Check or change the target moisture from the main screen.
 - a. Press “**MOIST CONTROL**” to access set-up screen.
 5. Check upper/lower unloading limits and change them if needed.
 6. Press the “**CONTROL MODE**” (moisture control set-up screen) and set mode to **AUTO**. The moisture controller will start adjusting the unload rate between the upper and lower limits of the unload speed to maintain the moisture coming out of the dryer.

Alarms

The controller checks the sensors and control status regularly. If abnormal conditions are detected, an alarm will go OFF and a message will come up on the main screen. **The dryer will be shut down.**

Alarm	Causes	Solution
Moisture out of range - Outgoing moisture has deviated by more than 2.5% from set point for more than one hour (AUTO mode only).	<ol style="list-style-type: none"> 1. Sensor box plugged/sensor was not covered by grain. 2. Dry sensor out of calibration. 3. Large fluctuation in wet grain moisture. 	<ol style="list-style-type: none"> 1. Clear the sampler and sensor box. 2. Calibrate the sensor. 3. Run in MANUAL for one pass.
Dry sensor error - Sensor reading is less than 6% or higher than 40%.	<ol style="list-style-type: none"> 1. Bad wiring. 2. Bad sensor. 3. Bad circuit board. 	<ol style="list-style-type: none"> 1. Check connection. 2. Change the sensor. 3. Change the circuit board.
Dry grain temperature out of range (0-300F).	<ol style="list-style-type: none"> 1. Bad wiring. 2. Bad sensor. 3. Bad circuit board. 	<ol style="list-style-type: none"> 1. Check connection. 2. Change the sensor. 3. Change the circuit board.
Wet sensor error - Sensor reading is less than 6% or higher than 40%.	<ol style="list-style-type: none"> 1. Bad wiring 2. Bad sensor 3. Bad circuit board 	<ol style="list-style-type: none"> 1. Check connection. 2. Change the sensor. 3. Change the circuit board.
Wet grain temperature out of range (0-300°F).	<ol style="list-style-type: none"> 1. Bad wiring. 2. Bad sensor. 3. Bad circuit board. 	<ol style="list-style-type: none"> 1. Check connection. 2. Change the sensor. 3. Change the circuit board.
Column grain temperature RTD out of range (0-300°F).	<ol style="list-style-type: none"> 1. Bad wiring. 2. Bad sensor. 3. Bad circuit board. 	<ol style="list-style-type: none"> 1. Check connection. 2. Change the sensor. 3. Change the circuit board.

Access Drying History

1. Press the “**DATA LOG**” button (main screen).
2. Press the browse buttons to browse the History screen. The controller logs quarterly data up to 120 records (i.e. 30 hours) into the archive.

6. Tri-Point Moisture Controller

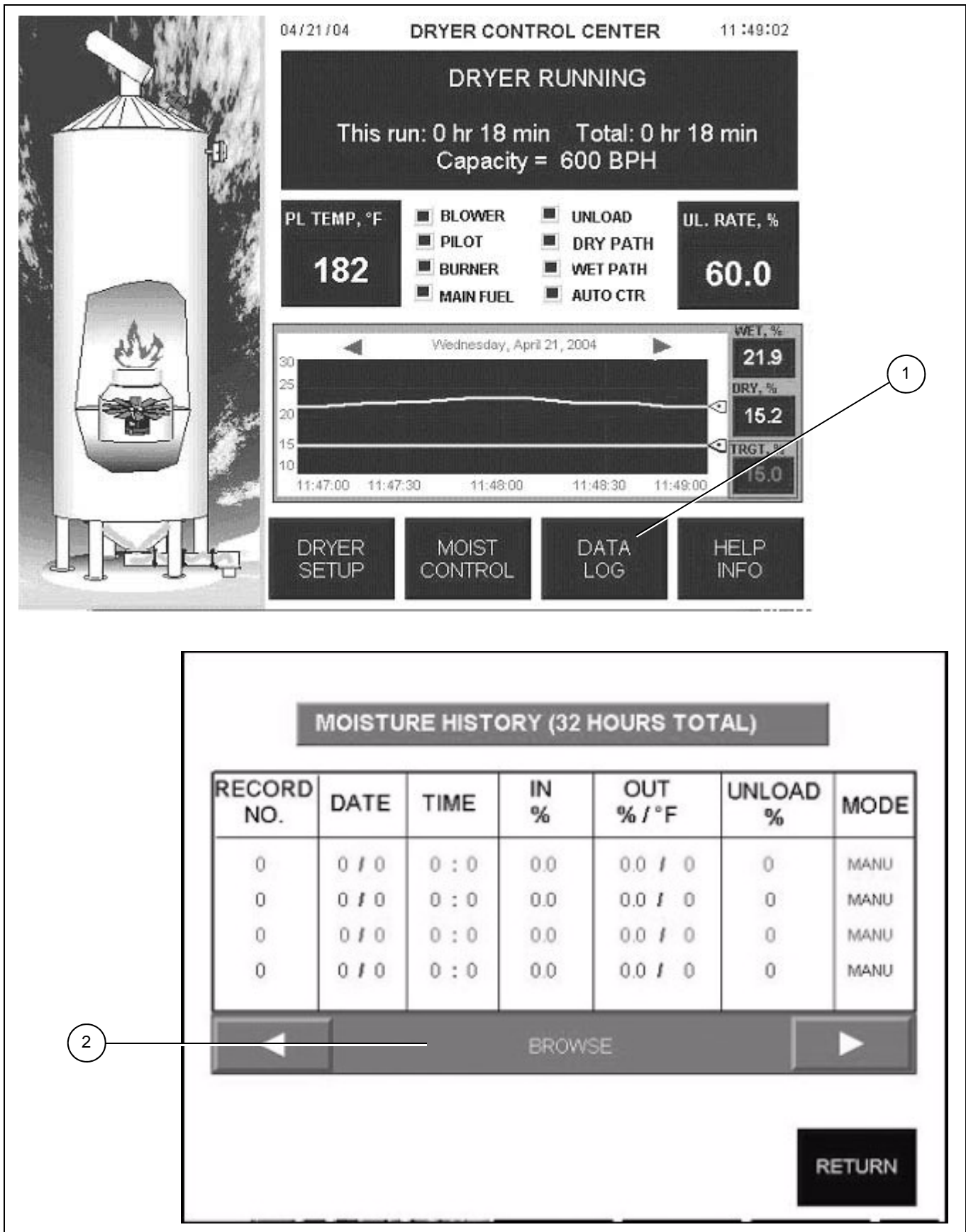

Figure 6D

Before and inspection, service or maintenance:



Shut off electrical power and lock.



Shut off fuel and lock.

Pre-Season Inspection and Service

Each season we recommend the checks,

Inspect	Action
Open power and control box and inspect for:	
Moisture.	1. Dry and address leak.
Rodent damage.	1. Replace/repair.
Foreign material.	1. Remove.
Loose terminal connections.	1. Tighten.
Damaged wiring	1. Replace.
Fans, motors and metering system	
Lubricate	1. Refer to lubrication table on Page 38 .
Belt tension	1. Re-tension if slipping.
Sweep unload (Zimmerman models)	1. Clean.
Hopper unload (GSI models)	2. Check for excessive wear. 3. Replace damaged parts.
Discharge cover plates	1. Must be in placed and clamped down. 2. Lube metering system access door cover hold-down latches.
Check burner	
	1. Remove any 'end of season' covers.
Air mixing plate	1. Clear all air holes.
Burner ports	1. Remove rust and debris (if required drill out with 2.2 mm drill).
Flame rod/spark igniter connections	1. Replace if damaged.

7. Maintenance

Pre-Season Inspection and Service (Continued)

Inspect	Action
Gas train	
Drain valve	1. Drain out condensate/dirt.
Modulating valve	1. Lubricate linkage. 2. Check butterfly operation in modulating valve.
Solenoid valves/pressure switches	1. Check and if required replace damaged connections.
Pressure test	1. Pressures with hand bellows to 350 mBar. 2. Check for leaks (repair). 3. Check slam-shut 4. Check relief valve. 5. Check gas pressure gauges.
General	1. Inspect Bindicator grain level switches. 2. Inspect metering system access door cover seals.

Mid Season Inspection and Service

Inspect	Action
Moving parts.	1. Lubricate as per lubrication table on Page 38 .
Cooling section	1. Drying milo, check and clean every day.
	2. Other products, check and clean every week.
	3. Sweep down the cooling section sheets if necessary.
Heating section	1. Every day check hopper divider between heat and cool section. Must be clean and open.
Grain discharge area	1. Keep clean every day.
Plenum roof	1. After idle period clean off and stuck, wet grain.
Grain columns	1. Check loading evenly.
Upper outer sheets	1. Wash off/dry off any wet sludge. Stop loading system and allow grain to drop below dirty area. Allow dirt to dry and knock/sweep off.

In Case of Fire



Call emergency fire department.



Evacuate area.



If safe to do so, shut off power and fuel supply to entire dryer and auxiliary equipment.

1. Locate the area of the fire.
2. If safe to do so tackle fire with a fire extinguisher, water hose or by removing the burning material.
3. Be aware of secondary fires.
4. Emergency discharge slide gates permit grain column emergency dumping. (Bottom of each column and hopper discharge area.)
5. A number of fire extinguishers should be kept with the dryer.

End of Season Service

1. Empty the dryer. Do not use for storage.
2. Clean out the plenum roof grain cushion and plenum roof.
3. Clean the grain exchangers.
4. Clean the diving hopper between heating and cooling section.
5. Clean the cooling chamber floor.
6. Clean the metering drum floor. Rake out by hand through slide gates in the hopper bottom of the dryer.
7. Open the gas train drain valve (gas must be OFF).
8. Cover the burner with a tarpaulin or plastic to maintain a clean burner.

7. Maintenance

Lubrication Table

Location	Method	Lubrication	Interval
Metering drum drive shaft bearing. (GSI hopper bottom dryers only.)	<ol style="list-style-type: none"> 1. Apply until grease shows past seal. 2. Wipe clean. 	High quality; grade #2 lithium based grease.	Annual (start of season)
Accutrol (sweep unload) top and bottom drive bearings. (On Zimmerman flat bottom dryers only.)			
Accutrol (sweep unload) coupling hub. (On Zimmerman dryers.)			
Blower shaft bearings.	<ol style="list-style-type: none"> 1. Count the grease gun pumps until grease shows past the seal. 2. Wipe clean. 3. Apply same amount for top bearing. 	High quality; grade #2 lithium based grease.	Every 4 weeks.
Blower motor bearings.	<ol style="list-style-type: none"> 1. Operate motor for 20 minutes. 2. Clean grease fitting. 3. Remove grease relief plug and apply required grease. 	High quality, grade #2 lithium based grease.	<ol style="list-style-type: none"> 1. 2 years (normal operation). 2. 8-10 months (continuous operation).
Metering variable speed drive motor.	<ol style="list-style-type: none"> 1. Allow motor to run for 10 minutes before replacing relief hardware. <p><i>Do NOT overgrease.</i></p>		
12' Diameter Accutrol gearbox. (Zimmerman dryers only.)	<ol style="list-style-type: none"> 1. Apply to first stage (upper) reduction mechanism through grease fitting provided (approximately 8 ml grease). 	High quality, grade #2 lithium based grease.	<ol style="list-style-type: none"> 1. Annually. 2. 3 years do complete change.
18' and 24' Diameter Accutrol gearbox. (Zimmerman dryers only.)	<ol style="list-style-type: none"> 1. Maintain to upper red line on oil level gauge. 	ISO VG 100 to 150 mineral-based oil.	<ol style="list-style-type: none"> 1. Annual. 2. 10000 hours or 2 years do complete change.
Metering drum gearbox. (GSI hopper bottom dryers only.)	<ol style="list-style-type: none"> 1. Fill to check plug. 	ISO VG 220 mineral-based oil.	

1. Most electrical or operating problems are displayed on the screen.
2. Ensure correct supply voltage.
3. Control circuits are 120V AC.
4. Safety circuits are 24V DC.

Troubleshooting - Drying Issues

Problem	What to do
Low dryer capacity.	<ol style="list-style-type: none"> 1. Check to make sure the dryer is always full of grain. 2. Check all grain columns to make sure they are all moving. 3. Check outside dryer screen for dirt build up. Clean if necessary.
Grain moisture discharges too wet.	<ol style="list-style-type: none"> 1. Reduce unload rate. 2. Or increase drying temperature.
Grain moisture discharges too dry.	<ol style="list-style-type: none"> 1. Increase unload rate. 2. Or decrease drying temperature.
Grain moisture discharges inconsistently.	<ol style="list-style-type: none"> 1. Check that plenum temperature is being held consistent. 2. Check for widely varying incoming moistures. 3. Check for plugged grain columns. 4. Verify that an adequate supply of grain is being provided to the dryer to maintain a grain seal within the dryer.
Burnt or scorched kernels appear during drying.	<ol style="list-style-type: none"> 1. Some varieties of grain or frost damaged grain are sensitive to higher drying temperatures. Lower drying temperatures. 2. If dryer is equipped with an external LP vaporizer, ensure that liquid propane is not passing through the vaporizer and going to the dryer.
Grain not moving through grain columns.	<ol style="list-style-type: none"> 1. Check the dryer for fines build up within the column. Empty if necessary. 2. Do not leave the dryer full for extended periods of time or during rainy weather without occasionally moving grain through it.

8. Troubleshooting

Troubleshooting - Burner

Problem	What to do
Pilot will not light.	<ol style="list-style-type: none"> 1. Check the gas shut off valve is open. 2. Check overpressure shut-off valve is open. 3. Check the pressure gauge located in the pilot line. 4. Check for click from pilot valve to indicate opening. 5. Disconnect pilot line from pilot solenoid. Blow line out with compressed air. 6. Refit the pilot line and adjust of flow of gas by adjusting flow. 7. Check voltage at pilot solenoid (120 VAC). 8. Check voltage at spark transformer (120 VAC). 9. Check burner control is not locked out. Re-set. 10. Check pilot area on burner. Clean if necessary. 11. If pilot area is hot (pilot lit but did not prove), check flame rod wiring/replace flame rod. 12. Check flame rod is not shorting to earth. 13. If pilot area is cold, replace spark plug/check HT lead/adjust spark gap. 14. If pilot still does not light replace burner control.
Pilot lights but main burner will not light.	<ol style="list-style-type: none"> 1. Check for water in gas train by opening drain valve. 2. Check main valves are opening (indicator lights on solenoid body). 3. Check burner ports are clean. 4. Check burner pressure.
Dryer will not reach operating temperature.	<ol style="list-style-type: none"> 1. Check modulating valve. 2. Check gas pressure. 3. Turn OFF gas and drain gas train.
Dryer loses flame at regular intervals while running.	<ol style="list-style-type: none"> 1. Check connections to flame rod. 2. Check flame rod is not touching burner. 3. Check pressure is stable.
Modulating valve does not open.	<ol style="list-style-type: none"> 1. Check operation of modulating valve. Check 120 VAC to black and white wires. 2. Short between "F" and "-" terminal to check motor drives fully open. 3. Check plenum set point.
Dryer not reaching temperature.	<ol style="list-style-type: none"> 1. Check dryer is completely fully. 2. Check burner pressures. 3. Check modulating valve function.

Troubleshooting - General

Problem	What to do
Control power switch will not light.	<ol style="list-style-type: none"> 1. Check main circuit breaker. 2. Check fuses "F1", "F2", "F3" in power box. 3. Check circuit breaker "CB-04" in power box. 4. Check MicroLogix PLC in control box.
Dryer shuts down, red light lights and horn sounds, display shows: "OVERHEAT AT _____" "POSSIBLE FIRE".	<ol style="list-style-type: none"> 1. Follow procedure for possible fire. 2. Check for a plugged or slow moving grain column.
Message: "UNLOAD DRIVE FAULT".	<ol style="list-style-type: none"> 1. Indicates that the metering system inverter drive has tripped. 2. Check for plugged metering drum or Accutrol metering system. 3. Reset drive by turning OFF the main circuit breaker for 15 seconds, or by pressing the "Stop" button on the inverter.
Message: "CONTACT FAILED TO CLOSE" "DRYCONVEYOR" "WET CONVEYOR" or any auxiliary starter.	<ol style="list-style-type: none"> 1. Indicates that any overload has occurred in the item indicated. 2. Reset the overload of the starter indicated in the power panel and fix the overload conditions.
Message: "OVERLOAD TRIPPED" "BLOWER ___ STARTER".	<ol style="list-style-type: none"> 1. Indicates that any overload has occurred in the item indicated. 2. Reset the overload of the starter indicated in the power panel and fix the overload conditions.

8. Troubleshooting

Troubleshooting - OIU (Screen) Messages

Message	What to do
Lost comm. to micro	Cycle the power
Overheat at top left possible fire	Check overheat condition and term. 101
Overheat at top right possible fire	Check overheat condition and term. 102
Overheat at middle left possible fire	Check overheat condition and term. 103
Overheat at middle right possible fire	Check overheat condition and term. 104
Overheat at lower left possible fire	Check overheat condition and term. 105
Overheat at lower right possible fire	Check overheat condition and term. 106
Overheat at inside left possible fire	Check overheat condition and term. 107
Overheat at inside right possible fire	Check overheat condition and term. 108
Overheat at plenum possible fire	Check overheat condition and term. 109
Overload tripped tri-starter	Check term. 300
Overload tripped blower 1 starter	Check term. 301
Overload tripped blower 2 starter	Check term. 302
Overload tripped blower 3 starter	Check term. 303
Overload tripped blower 4 starter	Check term. 304
Auxiliary stuck closed tri-starter	Check term. 200
Auxiliary stuck closed blower 1 starter	Check term. 201
Auxiliary stuck closed blower 2 starter	Check term. 202
Auxiliary stuck closed blower 3 starter	Check term. 203
Auxiliary stuck closed blower 4 starter	Check term. 204
Auxiliary contact failed to close tri-starter	Check term. 200
Auxiliary contact failed to close blower 1 starter	Check term. 201
Auxiliary contact failed to close blower 2 starter	Check term. 202
Auxiliary contact failed to close blower 3 starter	Check term. 203
Auxiliary contact failed to close blower 4 starter	Check term. 204
Switch open air pressure switch 1	Check term. 205
Switch open air pressure switch 2	Check term. 206
Switch open air pressure switch 3	Check term. 207
Switch open air pressure switch 4	Check term. 306
Switch open air pressure switch of combustion blower	Check term. 115
Lost flame	Check BCU and term. 114
Switch stuck closed Maxon valve	Check term. 113

Troubleshooting - OIU (Screen) Messages (Continued)

Message	What to do
Flame detected while burner is OFF.	Check if pilot or Maxon valves stuck open and check flame rod, BCU and term. 114.
High gas pressure switch open	Check Term. 111
Low gas pressure switch open make sure main gas valve is ON.	Check gas pressure and term. 110
High gas pressure switch open gas pressure too high.	Check term. 111
Low gas pressure switch open gas pressure too low	Check term. 110
Maxon valves not turn ON	Reset and try again
Plenum temperature RTD circuit open or shorted	Check the RTD wiring
Grain temperature RTD circuit open or shorted	Check the RTD wiring
Auxiliary stuck closed oil pump starter	Check term. 307
Auxiliary stuck closed combustion blower starter	Check term. 308
Auxiliary contact failed to close oil pump starter	Check term. 307
Auxiliary contact failed to close combustion blower starter	Check term. 308
Plug switch open dry path plugged	Clear dry path and check term. 309
Plug switch open hopper plugged	Clear hopper and check term. 310
Unload drive fault	Check the drive and term. 208
Overload tripped dry conveyor	Check term. 305
Plug switch open wet path plugged	Clear wet path and check term. 311
Auxiliary stuck closed dry conveyor	Check term. 209
Auxiliary stuck closed auxiliary dry conveyor	Check term. 210
Auxiliary stuck closed dry leg	Check term. 211
Auxiliary stuck closed top dry conveyor	Check term. 212
Unload monitor proximity switch open	Check the unload device and term. 313
Auxiliary stuck closed auxiliary wet conveyor	Check term. 215
Auxiliary stuck closed wet leg	Check term. 214
Auxiliary stuck closed top wet conveyor	Check term. 213
Contact failed to close dry conveyor	Check term. 209
Contact failed to close auxiliary dry conveyor	Check term. 210
Contact failed to close dry leg	Check term. 211
Contact failed to close top dry conveyor	Check term. 212
Contact failed to close auxiliary wet conveyor	Check term. 215
Contact failed to close wet leg	Check term. 214
Contact failed to close top wet conveyor	Check term. 213
Bindicator error UBS closed while LBS still open	Check term. 314 and 315

8. Troubleshooting

Troubleshooting - OIU (Screen) Messages (Continued)

Message	What to do
Shut down out of grain occurred at — dry sensor error moisture signal out of range.	Check the sensor wiring
Dry sensor error grain temperature signal out of range	Check the sensor wiring
Wet sensor error moisture signal out of range	Check the sensor wiring
Wet sensor error grain temperature signal out of range	Check the sensor wiring
Column grain RTD sensor error RTD out of range	Check the sensor wiring
Shut down by moisture controller failed to maintain to the target	Try again w/ close supervision
Ready to start	Press the dryer control START
Ready to start blower	Turn blower switch to ON to start
Ready to start burner	Turn burner switch to ON to start
Out of grain	Will shut down in ___ seconds
Start unload now	Or will shut down ___ seconds
Dryer cooling off current grain temperature = ____	Blower will shut down in ____ seconds/*N:5 or turn the Blower switch OFF to shut down now.
Wet path not on	Turn load switch to MANUAL or AUTO to start.
Filling the dryer	Please wait...
Dryer is full	Press Control Stop button to reset alarm, then press Control Start button to restart.
Emptying the dryer	Please wait...
No power to SLC Start checking please wait ___ seconds left Tri-Start ON ___ seconds left Starting blower 1 Starting blower 2 Starting blower 3 Starting blower 4 Purging ____ seconds left Open main fuel valves or will shut down in ____ seconds Ignition trial ____ seconds left	Pull E-Stop button out and check term. 100 for 24 VDC.
Firing valve limit switch open, open the firing valve Interlocked start dry conveyor first Interlocked start auxiliary dry conveyor first Interlocked start dry leg first Interlocked start top dry conveyor first Interlocked start auxiliary wet conveyor first Interlocked start wet leg first Interlocked start top wet conveyor first	Check term. 112

9. Tower Dryer Control Panel Wiring Diagrams

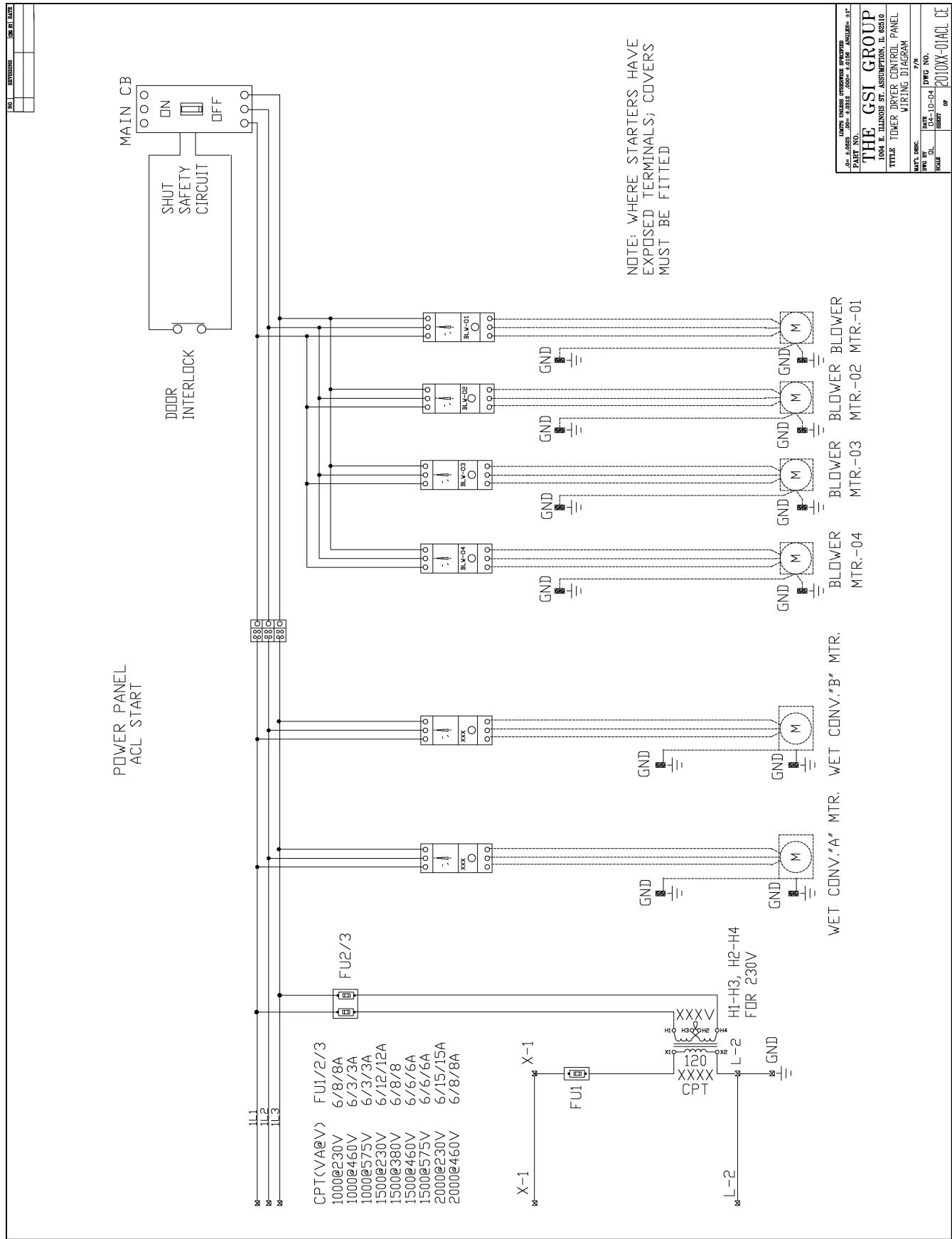

Figure 9A

9. Tower Dryer Control Panel Wiring Diagrams

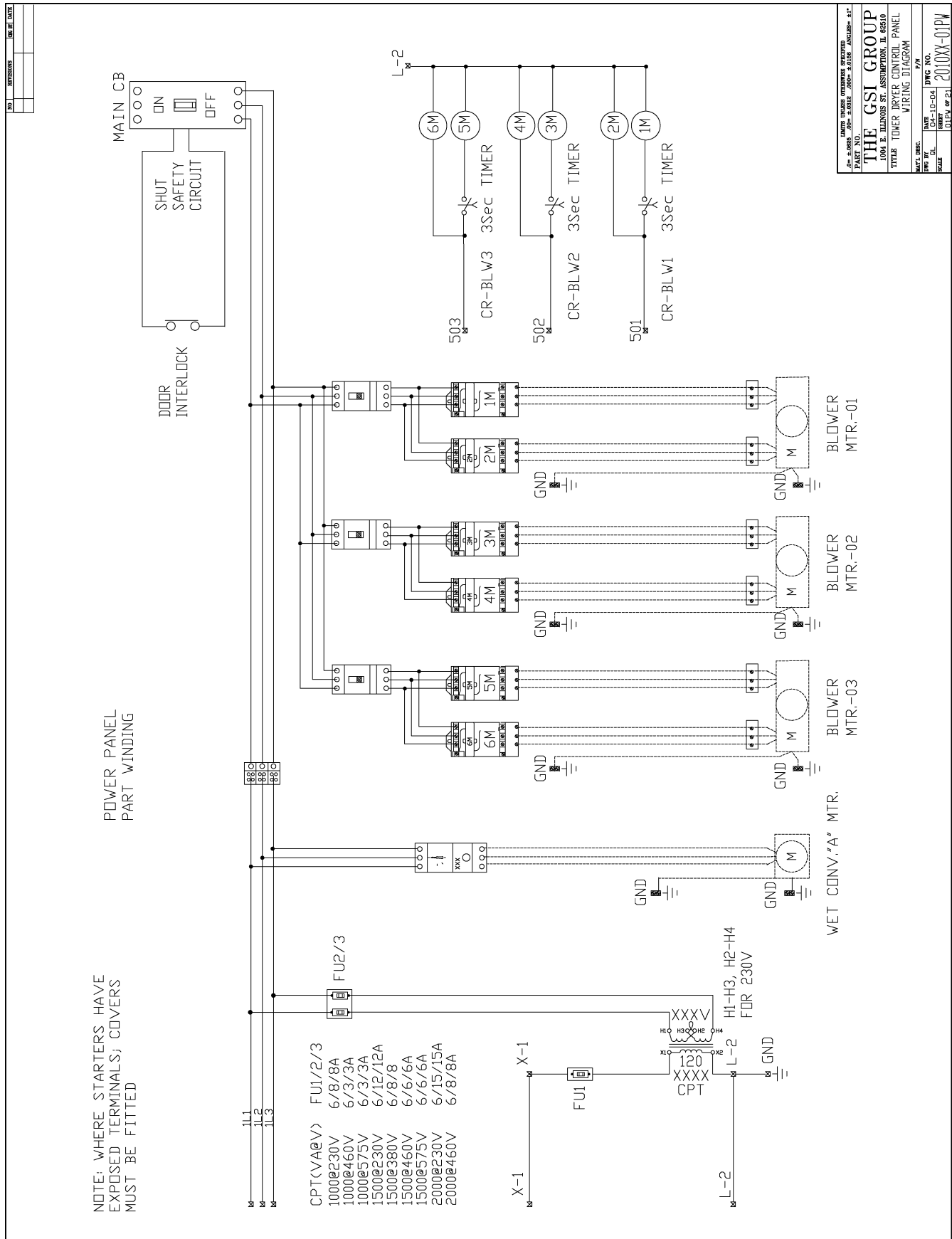
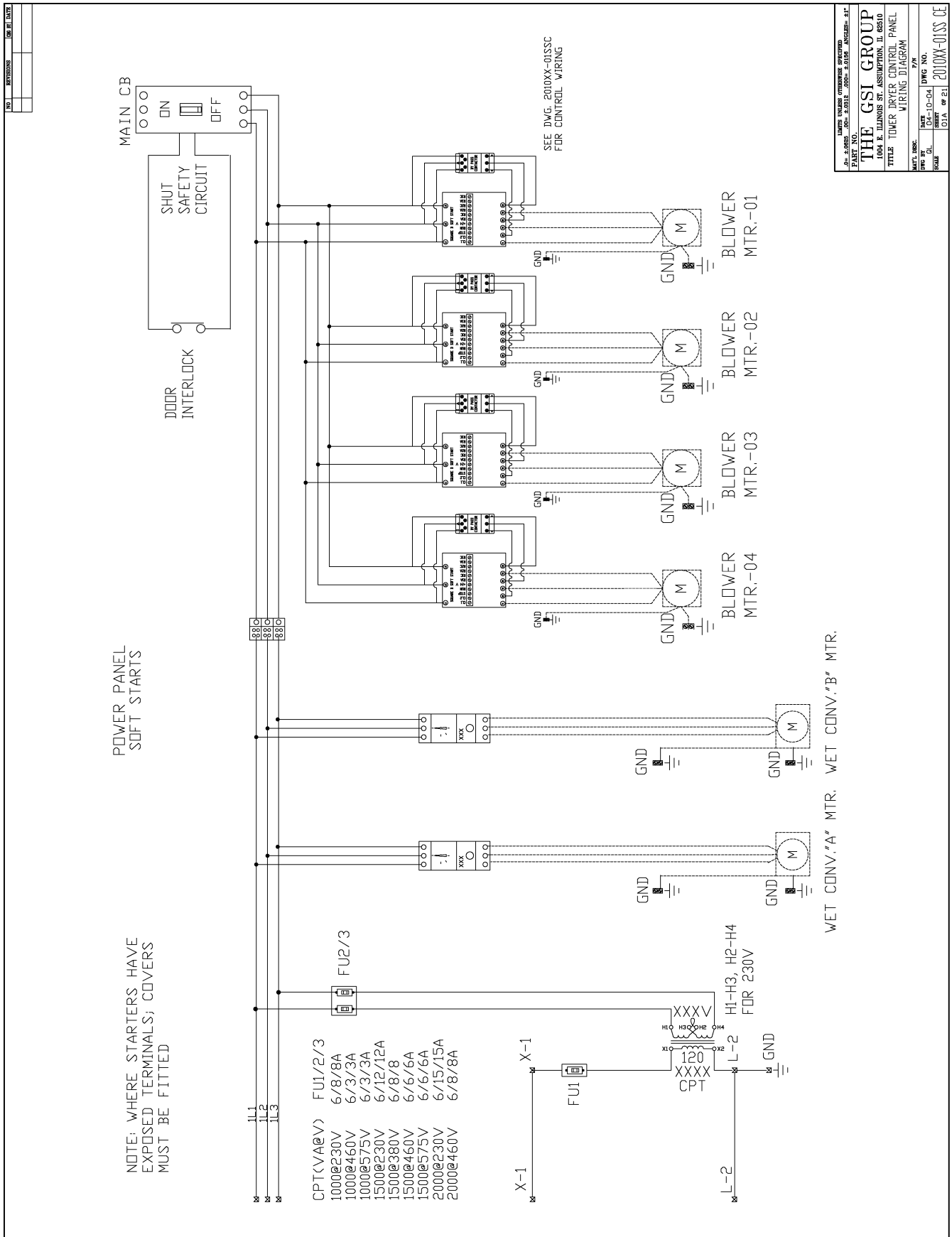

Figure 9B

9. Tower Dryer Control Panel Wiring Diagrams



DRAWN BY: [REDACTED]		DATE: [REDACTED]	
CHECKED BY: [REDACTED]		DATE: [REDACTED]	
THE GSI GROUP 1004 E. ILLINOIS ST., ASSUMPTION, IL 62510 TITLE: TOWER DRYER CONTROL PANEL WIRING DIAGRAM P/N: [REDACTED]			
REV. NO.	DATE	BY	DESCRIPTION
001	01/11/04	[REDACTED]	2010XX-01SSC CE

Figure 9C

9. Tower Dryer Control Panel Wiring Diagrams

UNITS UNLESS OTHERWISE SPECIFIED	
PART NO.	REV. 10/01
THE GSI GROUP	
1000 E. ILLINOIS ST. ASSHUR, ILL. 62509	
TITLE TOWER DRYER SOFT STARTERS	
CONTROL WIRING DIAGRAM	
DATE DESIGNED	DATE CHECKED
BY F.W.	BY J.M.
SCALE	SHEET #
	OF 1

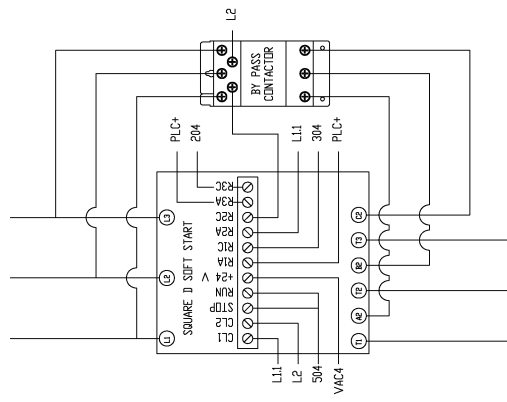

BLOWER #4

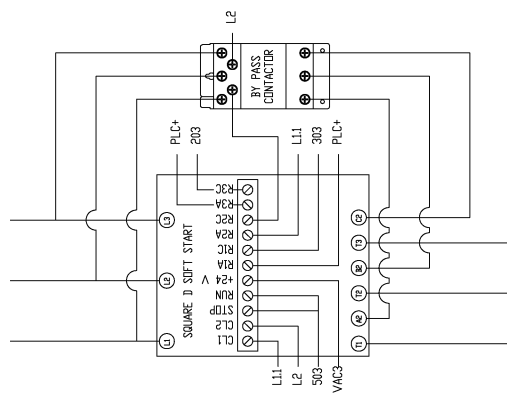

BLOWER #3

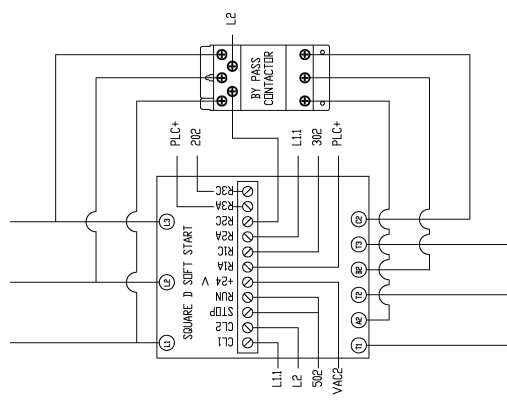

BLOWER #2

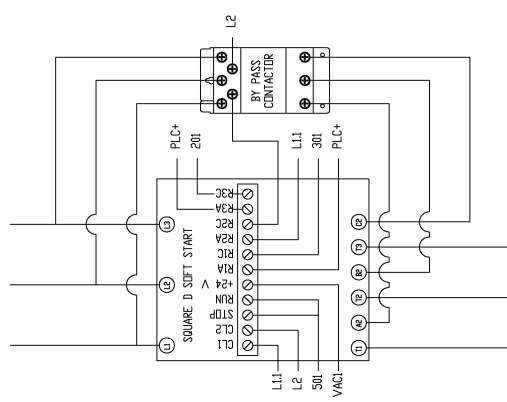

BLOWER #1

- L1,1 - 120VAC
- L2 - NEUTRAL
- PLC+ - EXTERNAL 24 VDC PS
- 201 - STARTER ACK TO PLC
- 301 - STARTER FAULT TO PLC
- VAC1 - PLC BLOWER #1 START RELAY
- 501 - PLC BLOWER #1 START RELAY

NOTE: WHERE STARTERS HAVE EXPOSED TERMINALS; COVERS MUST BE FITTED

Figure 9D

9. Tower Dryer Control Panel Wiring Diagrams

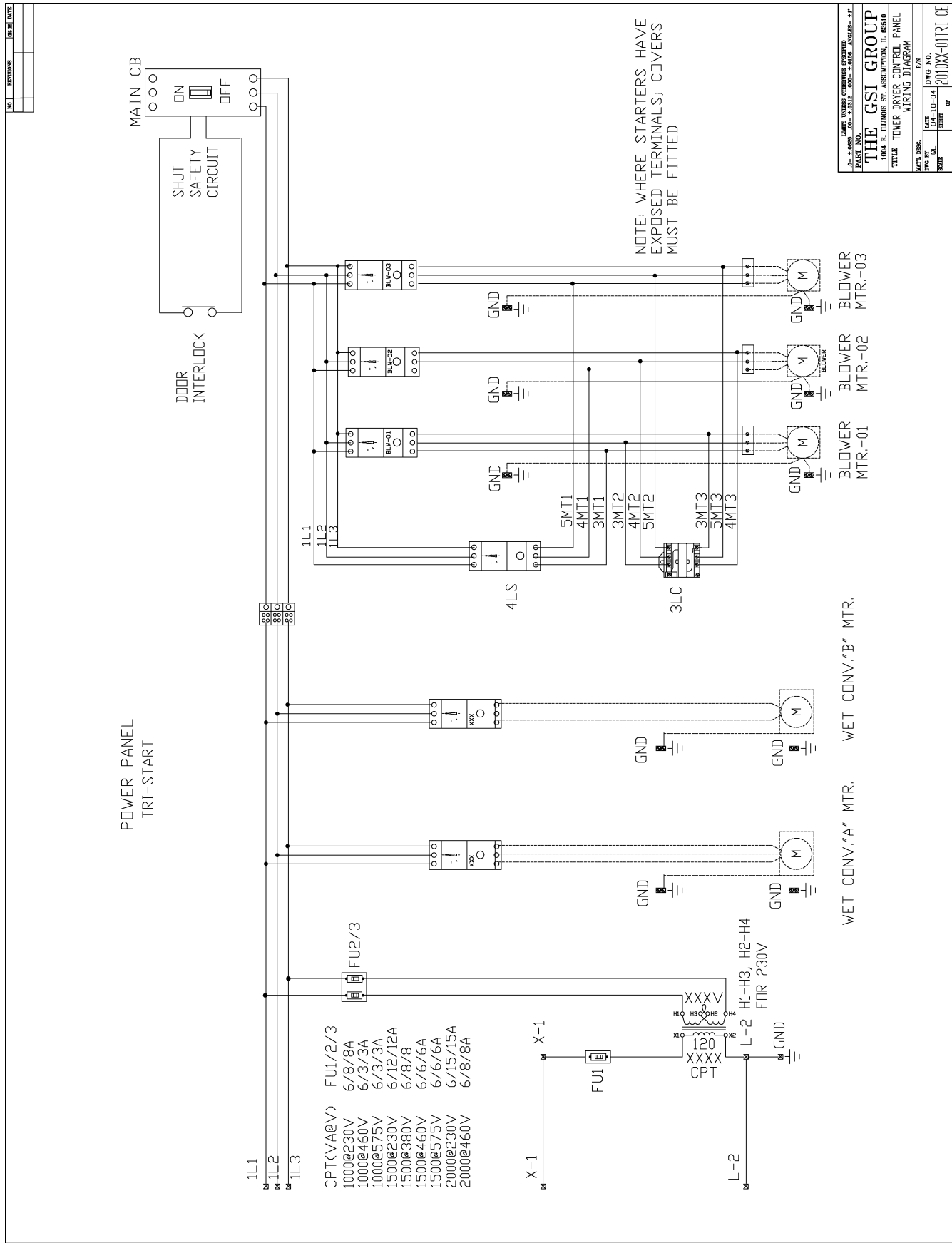
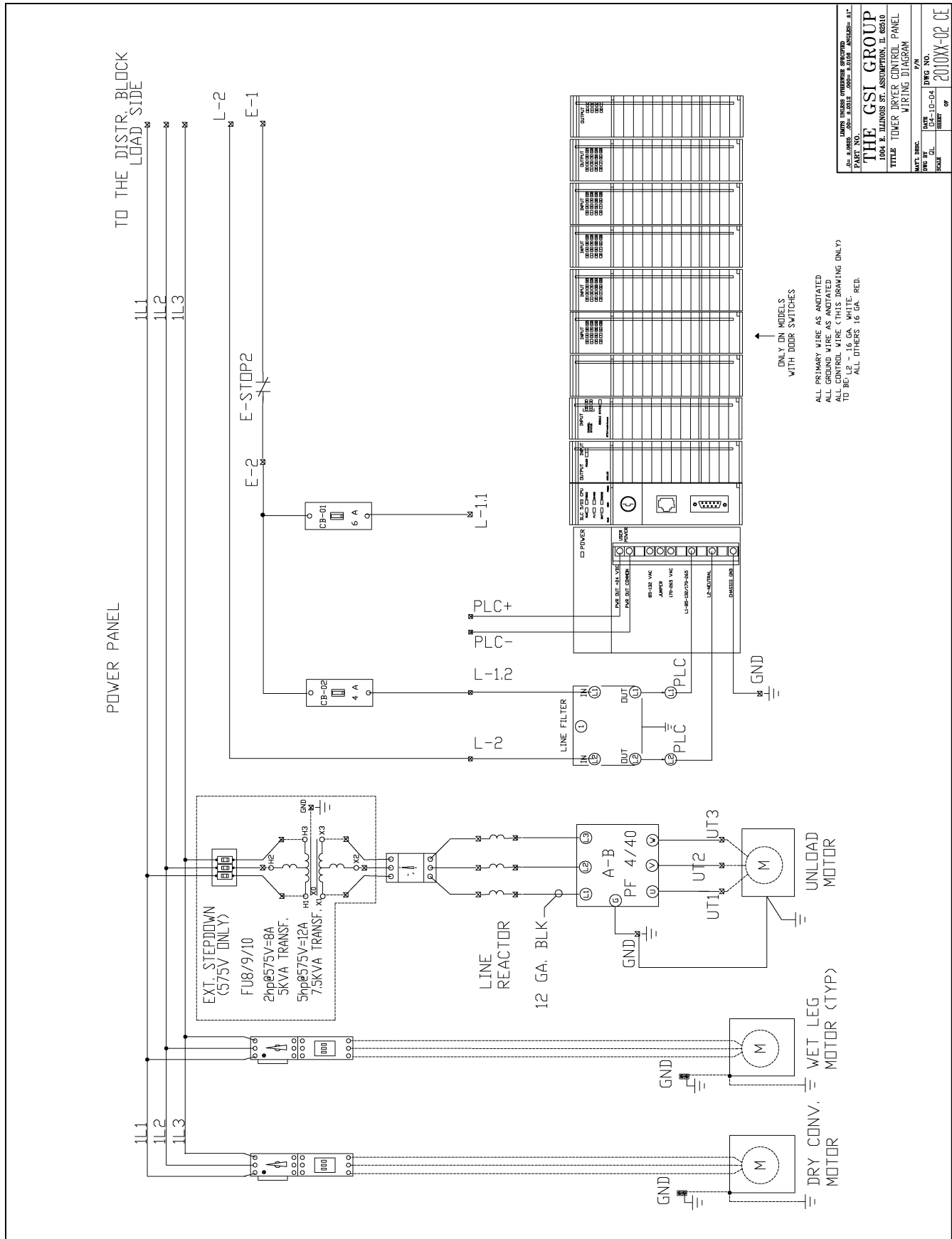

Figure 9E

9. Tower Dryer Control Panel Wiring Diagrams



DATE	BY	NO.
04-10-04	778	200X-02 CE
SCALE	SHEET	OF

THE GSI GROUP
1004 E. ILLINOIS ST. ASSUMPTION, IL 62510
TOWER DRYER CONTROL PANEL
WIRING DIAGRAM

Figure 9F

9. Tower Dryer Control Panel Wiring Diagrams

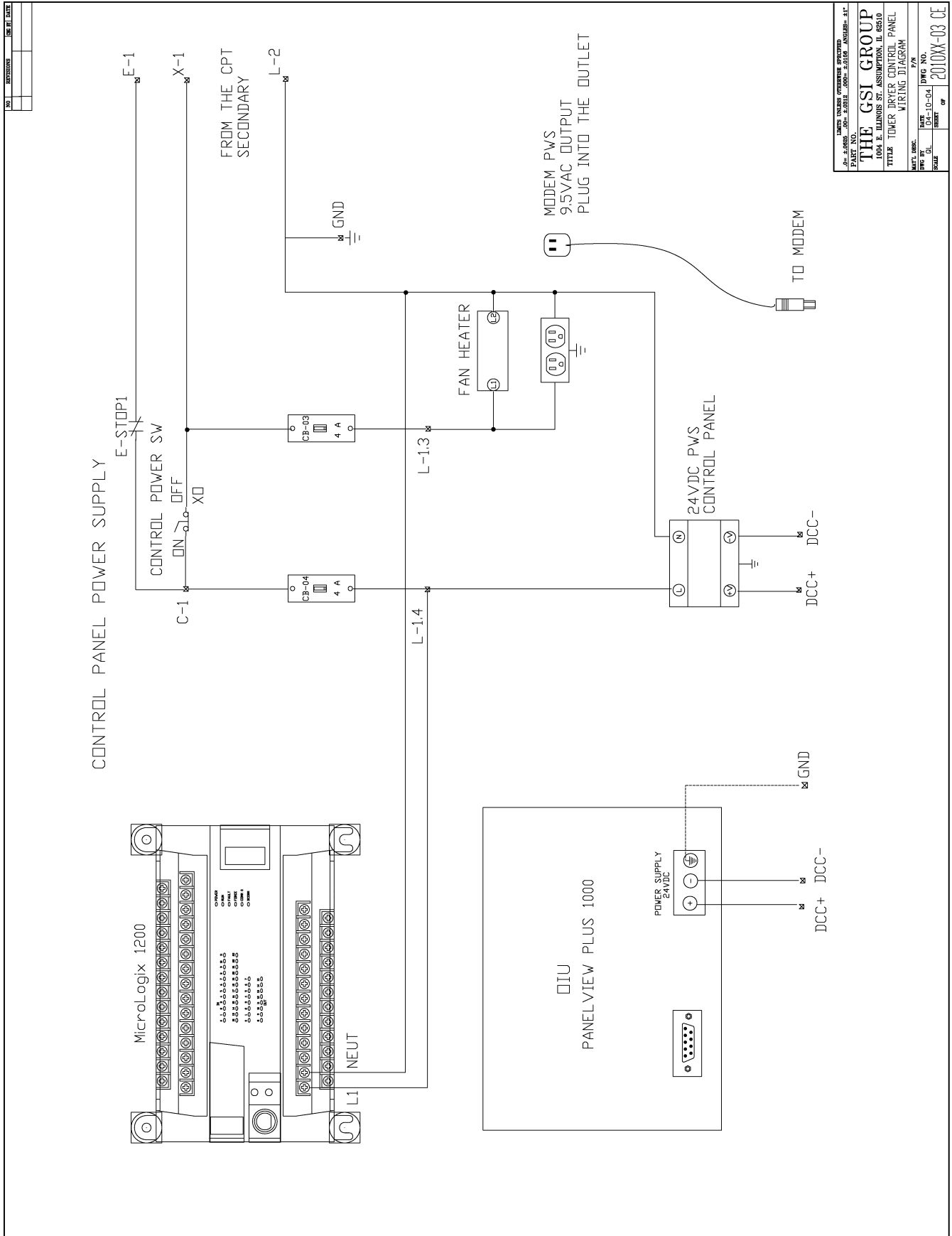
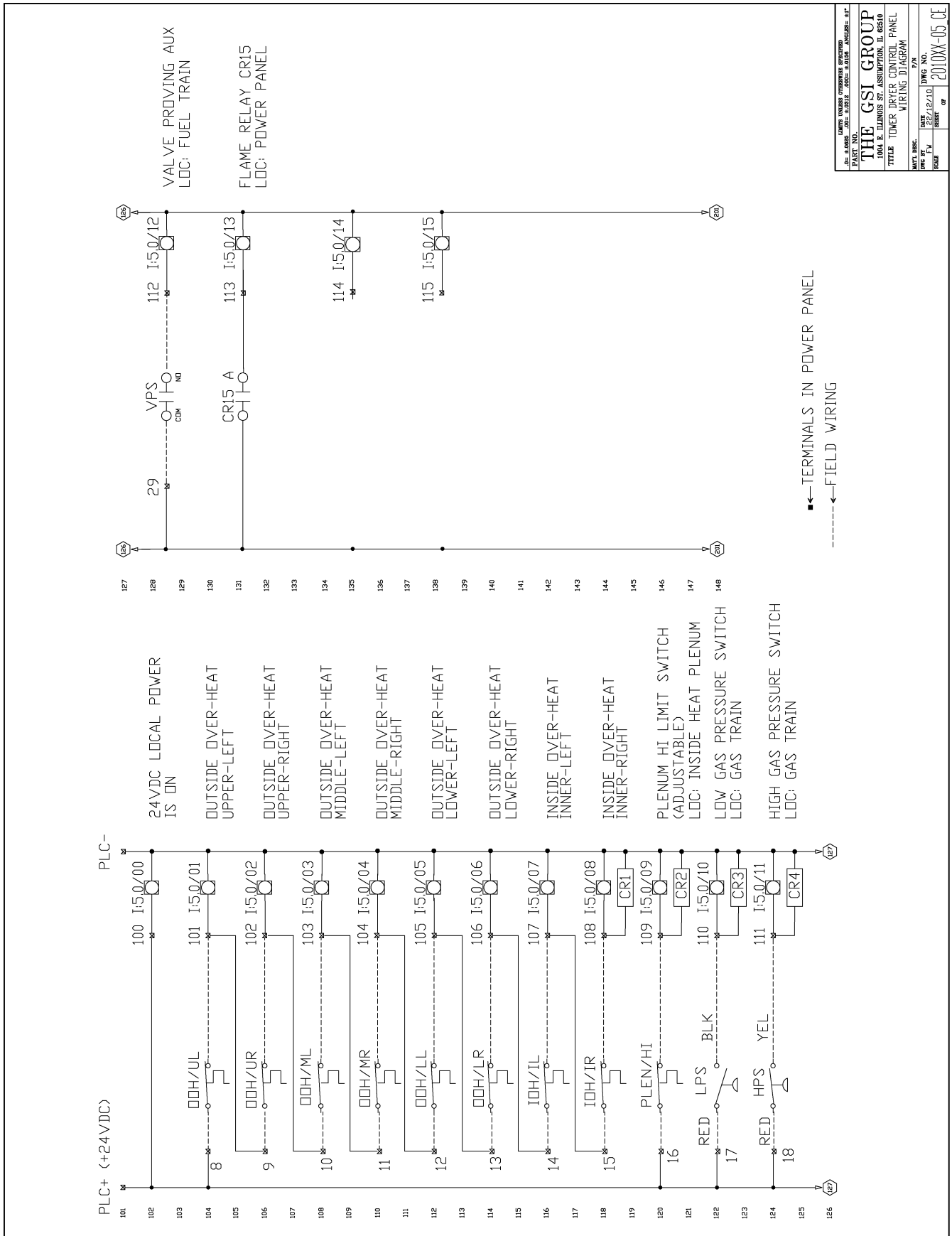

Figure 9G

9. Tower Dryer Control Panel Wiring Diagrams



<small>THE GSI GROUP 1004 E. DUNDAS ST. ASSUMPTION, IL 62510 TITLE: TOWER DRYER CONTROL PANEL WIRING DIAGRAM PART NO. 1796-05-01 REV. 01</small>	
<small>DATE: 12/10/10 BY: P. J. SHERIDAN SCALE: 1"=1'</small>	<small>DATE: 12/10/10 BY: P. J. SHERIDAN SCALE: 1"=1'</small>
<small>REV. 01</small>	<small>REV. 01</small>
<small>2010XX-05-01</small>	<small>2010XX-05-01</small>

Figure 9I

9. Tower Dryer Control Panel Wiring Diagrams

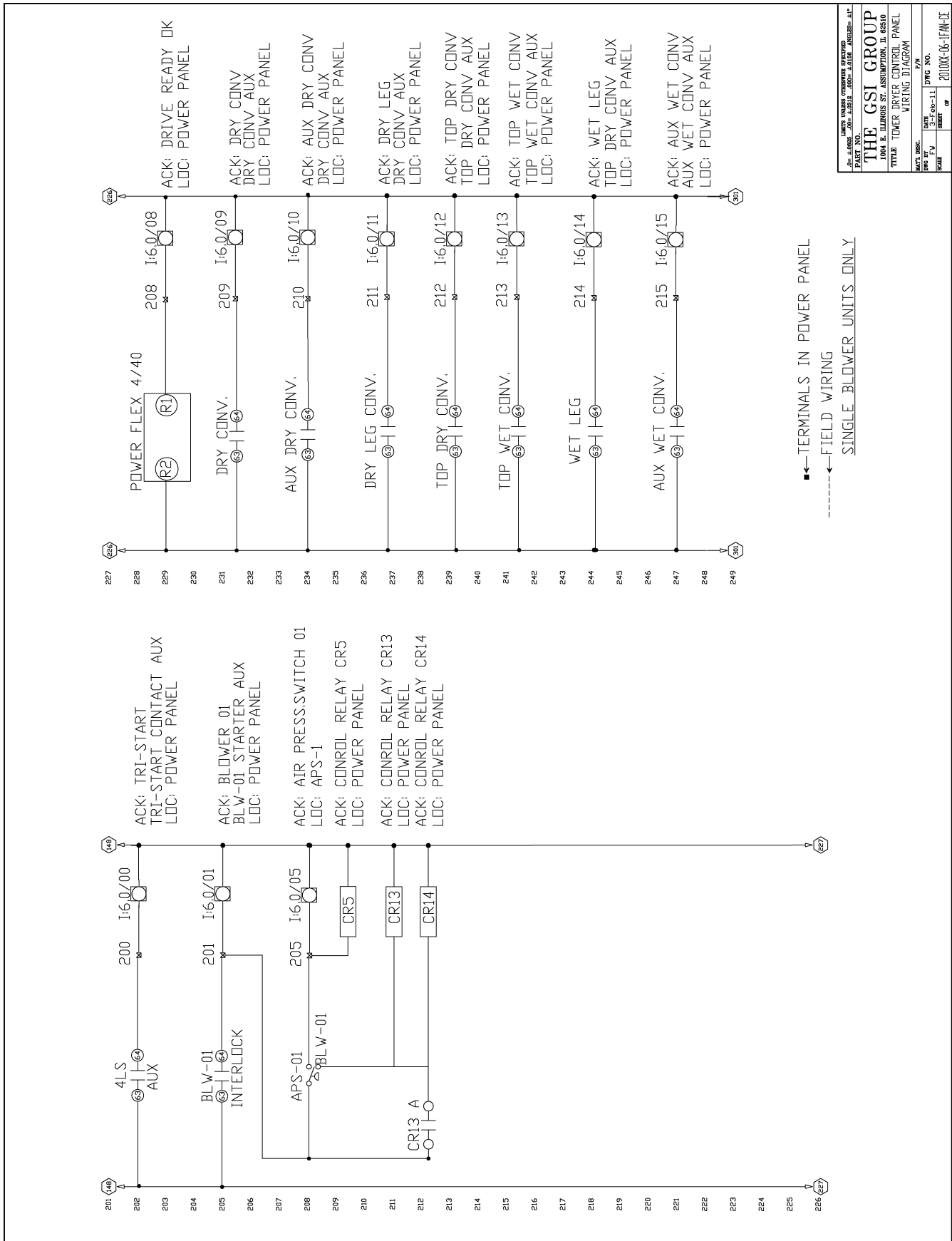

LIMIT INCREASE OPERATING FREQUENCY	
REV. NO.	DATE
1	3-16-11
SCALE	DWG. NO.
	2008X-06-1FAN-01
THE GSI GROUP 1004 E. TILANDIS ST. ASSUMPTION, IL 60810 WIRING DIAGRAM	

Figure 9J

9. Tower Dryer Control Panel Wiring Diagrams

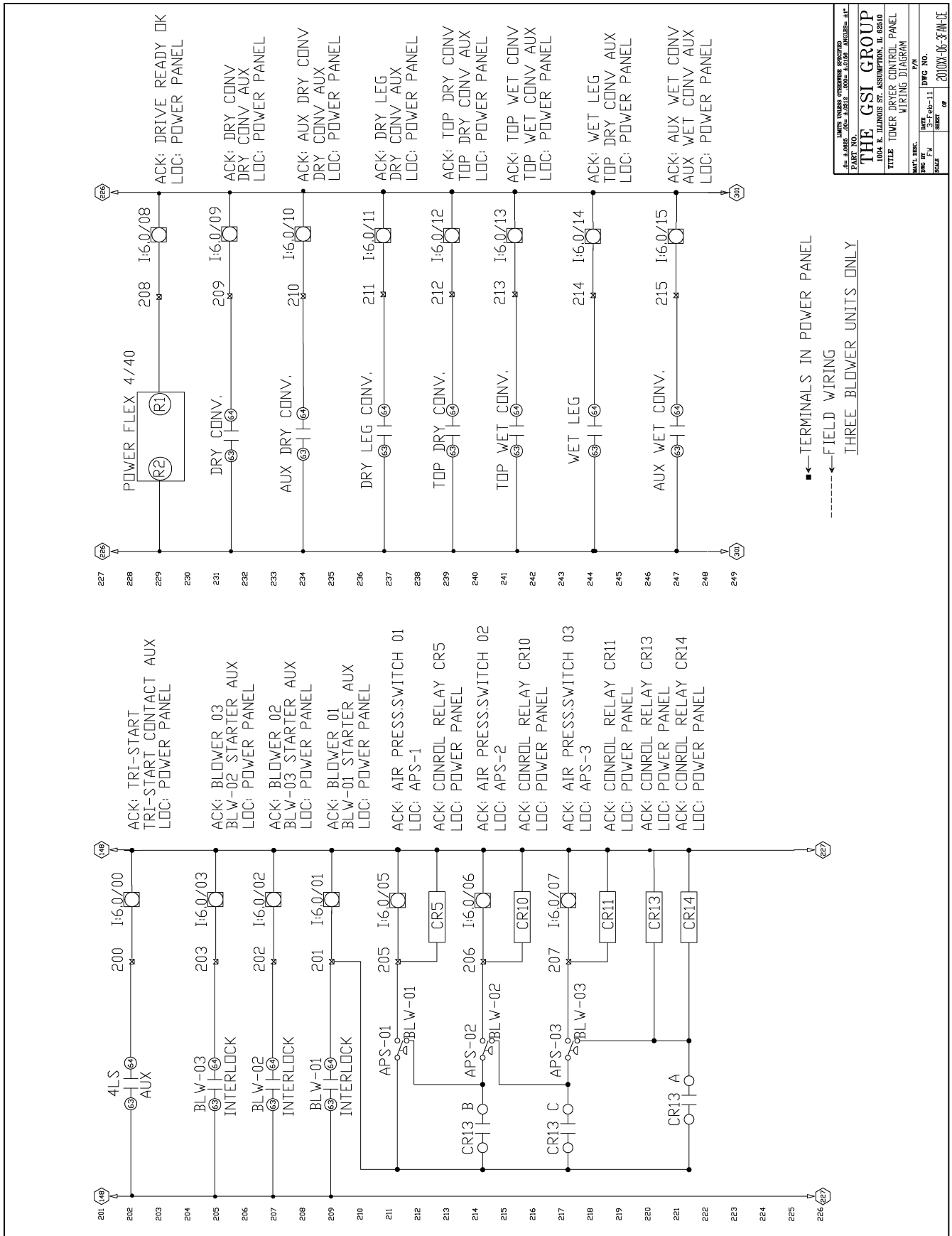

<small>THE GSI GROUP 1004 S. ILLINOIS ST. ASSUMPTION, IL 62610 TITLE: TOWER DRYER CONTROL PANEL WIRING DIAGRAM DATE: 05-11-11 DWG. NO.: 2010KX-05-35A-CE</small>	
<small>DATE: 05-11-11 DWG. NO.: 2010KX-05-35A-CE</small>	<small>DATE: 05-11-11 DWG. NO.: 2010KX-05-35A-CE</small>

Figure 9K

9. Tower Dryer Control Panel Wiring Diagrams

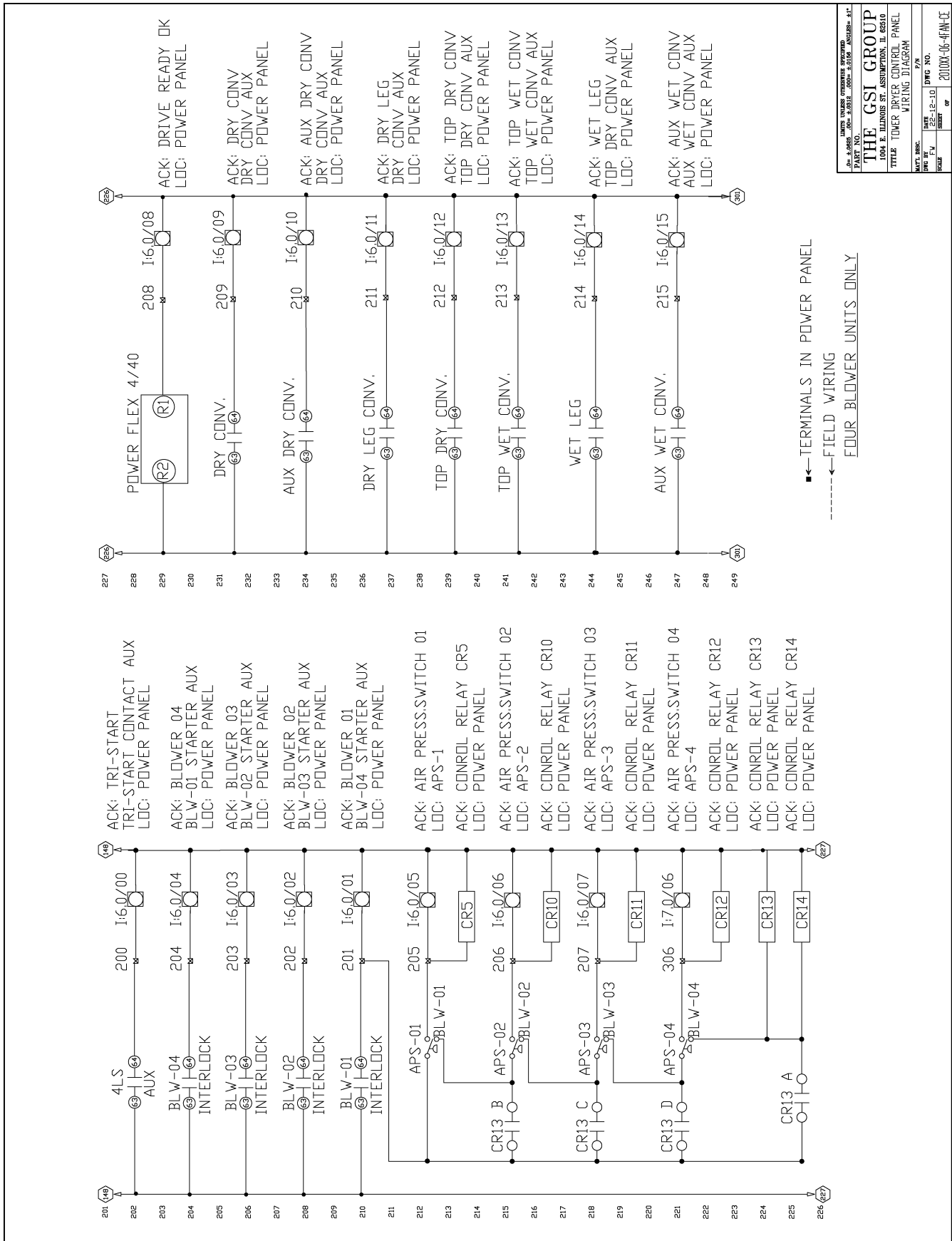

LIMIT INHALES OPERATING SPECIFIED		REVISED	
BY: J. BARR	DATE: 08/11/11	BY: J. BARR	DATE: 08/11/11
THE GSI GROUP			
1004 E. ILLINOIS ST. ASSUMPTION, IL 62510			
TITLE: TOWER DRYER CONTROL PANEL WIRING DIAGRAM			
DATE: 08/11/11	DATE: 08/11/11	DATE: 08/11/11	DATE: 08/11/11
SCALE: 1/1	SCALE: 1/1	SCALE: 1/1	SCALE: 1/1
DRAWING NO. 2010X-16-41A-CE		REV. NO. 1/1	

Figure 9L

9. Tower Dryer Control Panel Wiring Diagrams

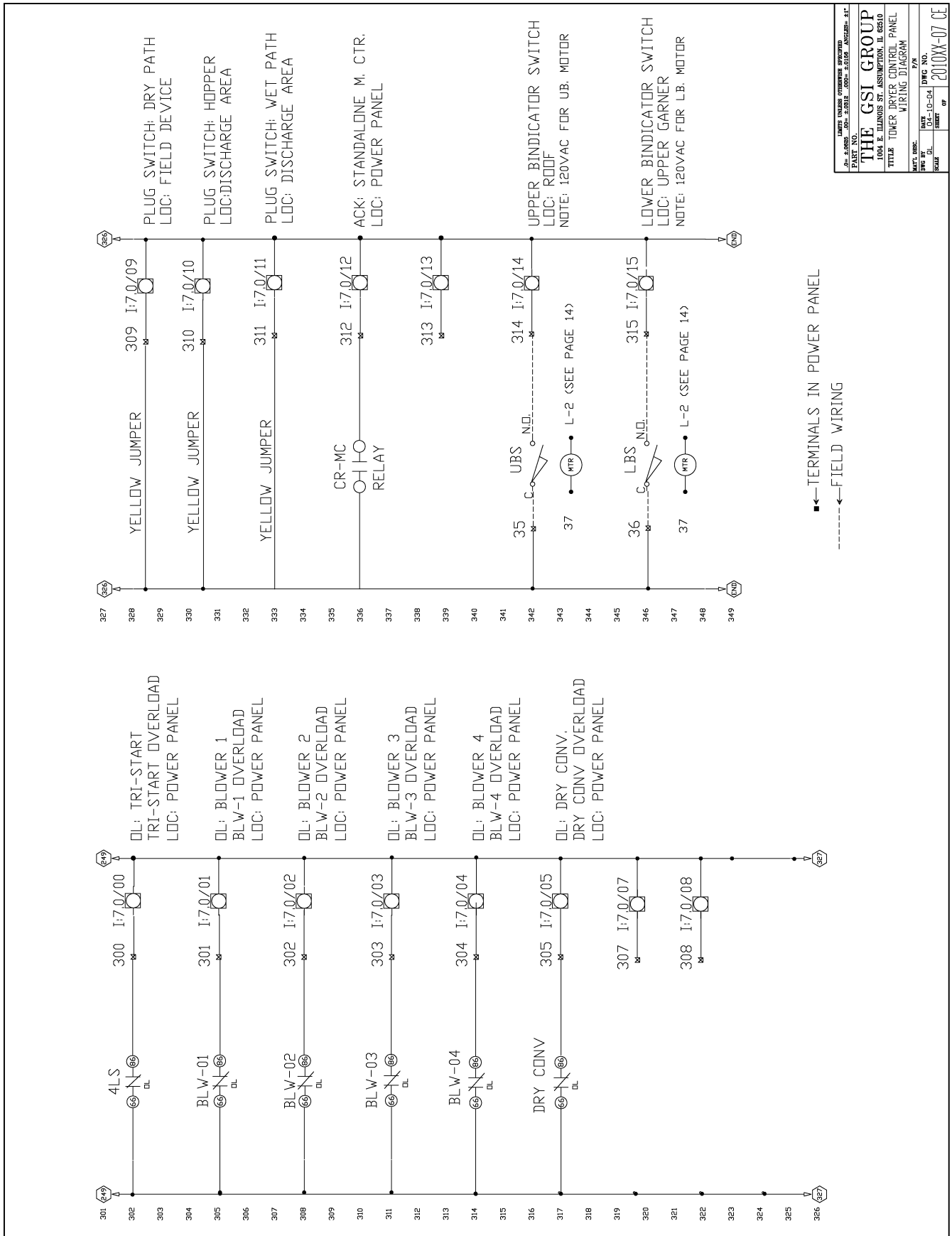

THE GSI GROUP	
1004 E. ILLINOIS ST. ASSUMPTION, IL 62610	
TITLE: TOWER DRYER CONTROL PANEL WIRING DIAGRAM	
DATE: 10-24-11	DRG NO. 2010WX-07 CE
SCALE: 1/16"	REV: 0
BY: [Signature]	CHK: [Signature]
DATE: 10-24-11	DATE: 10-24-11

Figure 9M

9. Tower Dryer Control Panel Wiring Diagrams

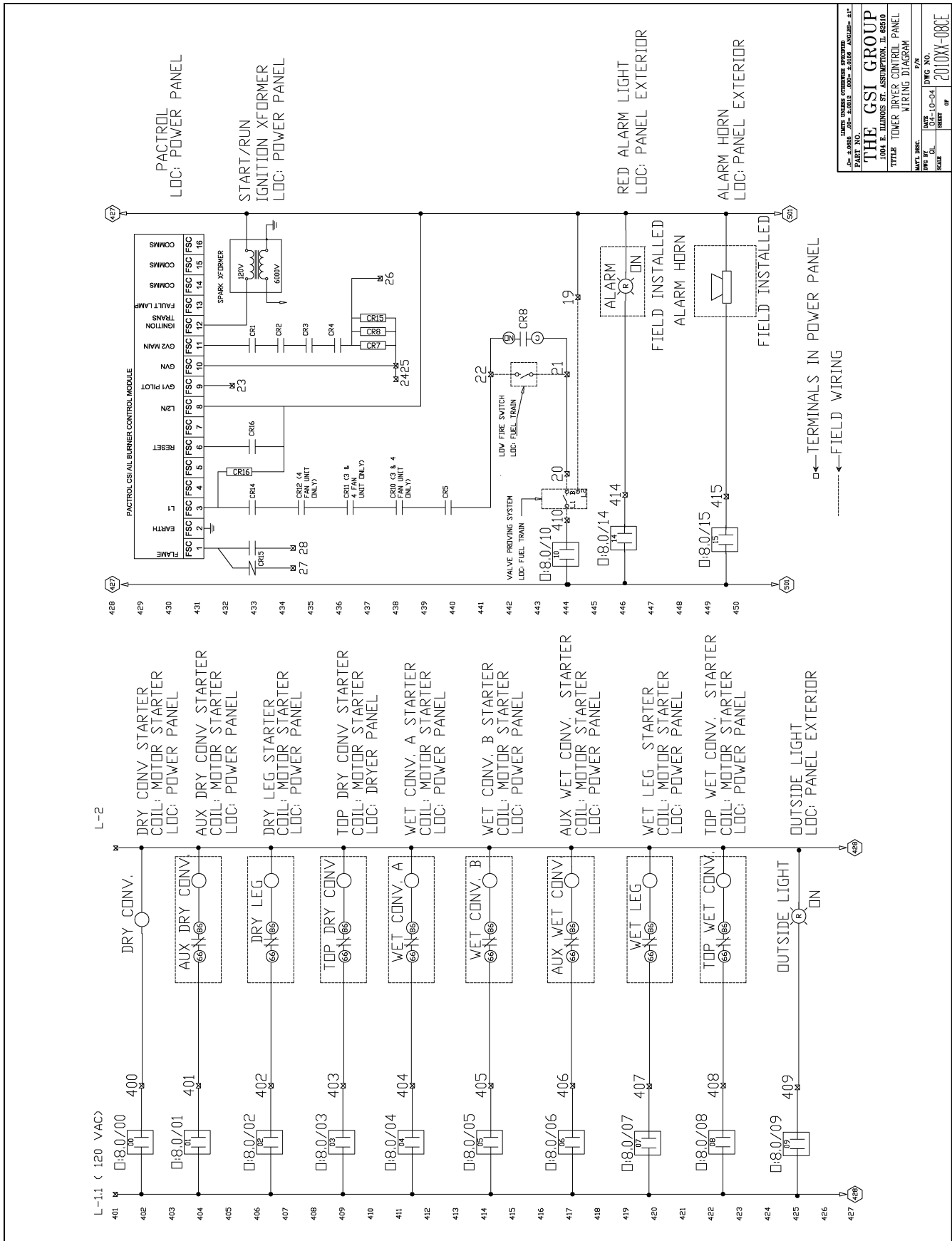

THE GSI GROUP 1004 E. TILANDIS ST. ASSUMPTION, IL 62510 WIRING DIAGRAM	
DATE: 10-04-04 SCALE: 1:1	DWG. NO.: 2010XX-08CE 7/24

Figure 9N

9. Tower Dryer Control Panel Wiring Diagrams

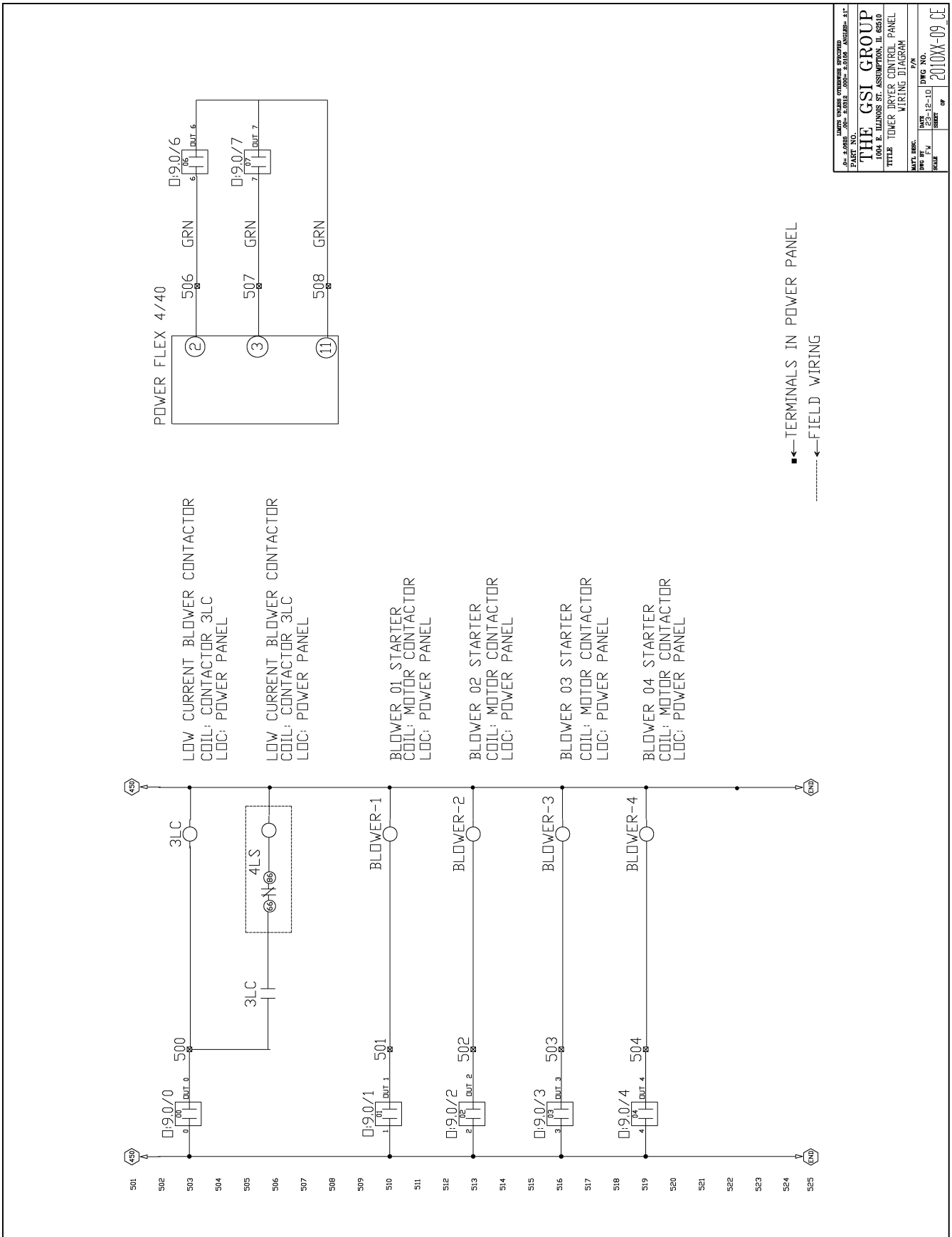

Figure 90

9. Tower Dryer Control Panel Wiring Diagrams

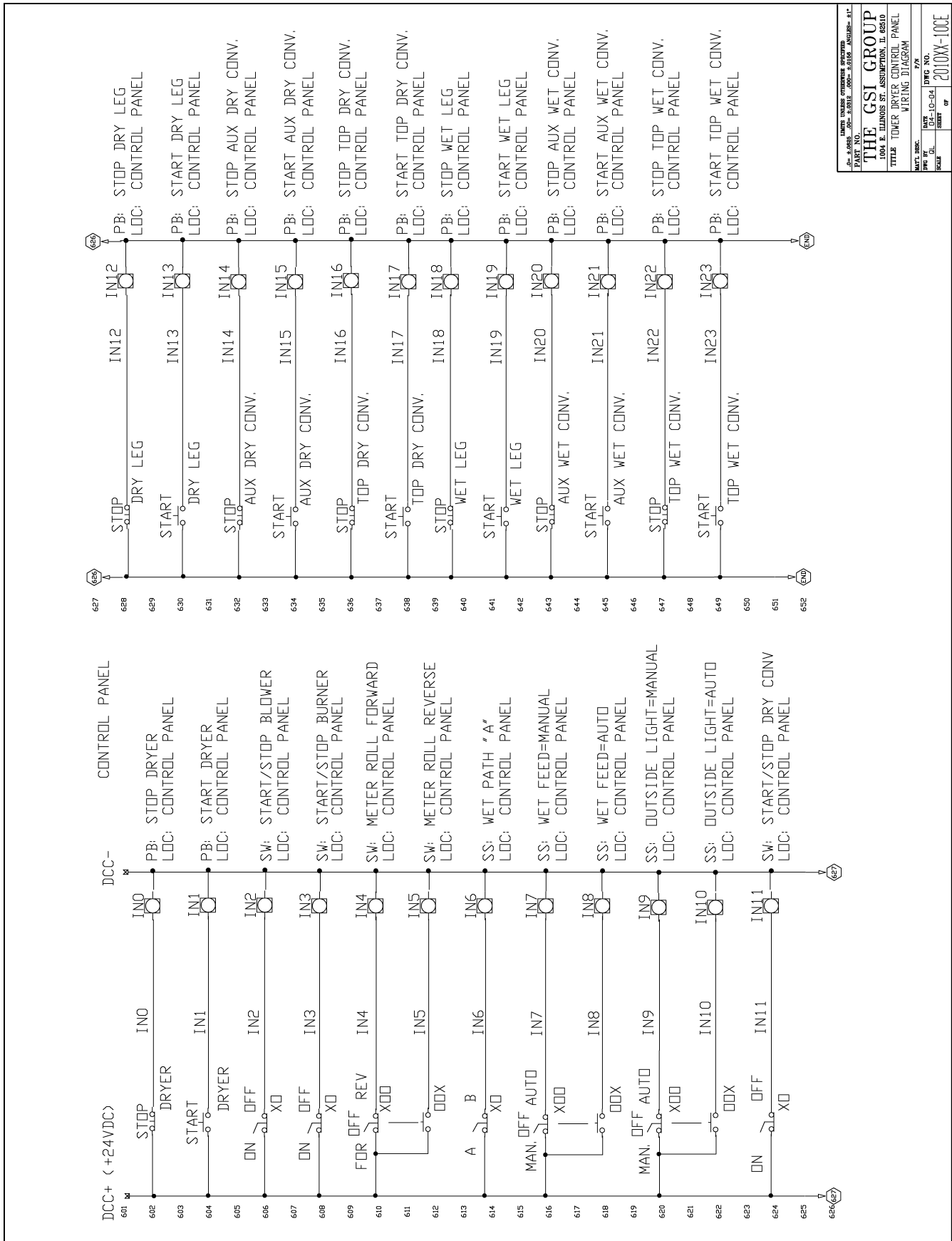
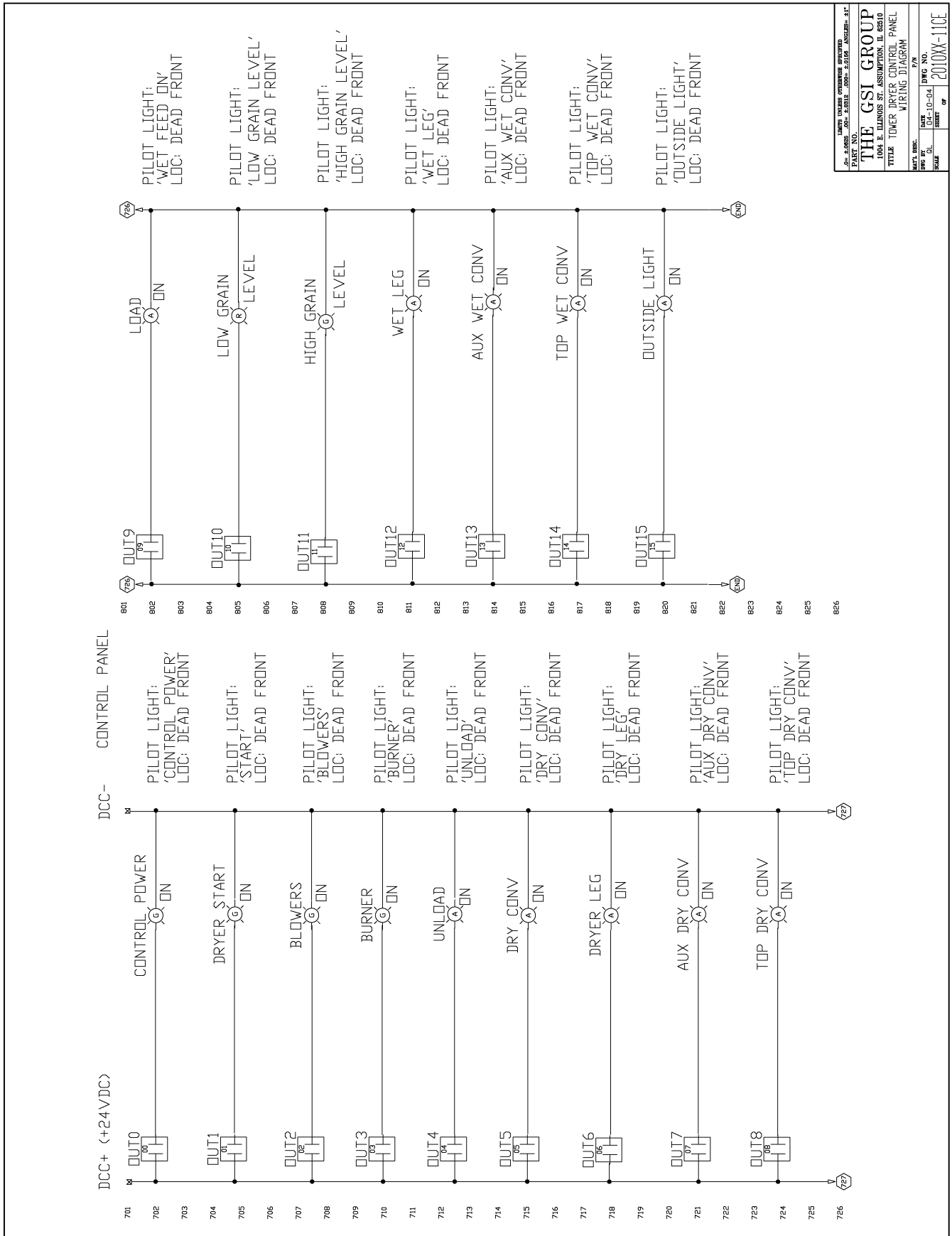

Figure 9P

9. Tower Dryer Control Panel Wiring Diagrams



<small>THE GSI GROUP 1004 E. DUNROSS ST., ASSUMPTION, IL 62510 TITLE: TOWER DRYER CONTROL PANEL WIRING DIAGRAM</small>	
<small>PART NO.</small>	<small>REV. NO.</small>
<small>DATE</small>	<small>DWG. NO.</small>
<small>SCALE</small>	<small>OF</small>
<small>MAT. DESC.</small>	<small>P/N</small>
<small>DATE</small>	<small>2010XX-11CE</small>

Figure 9Q

9. Tower Dryer Control Panel Wiring Diagrams

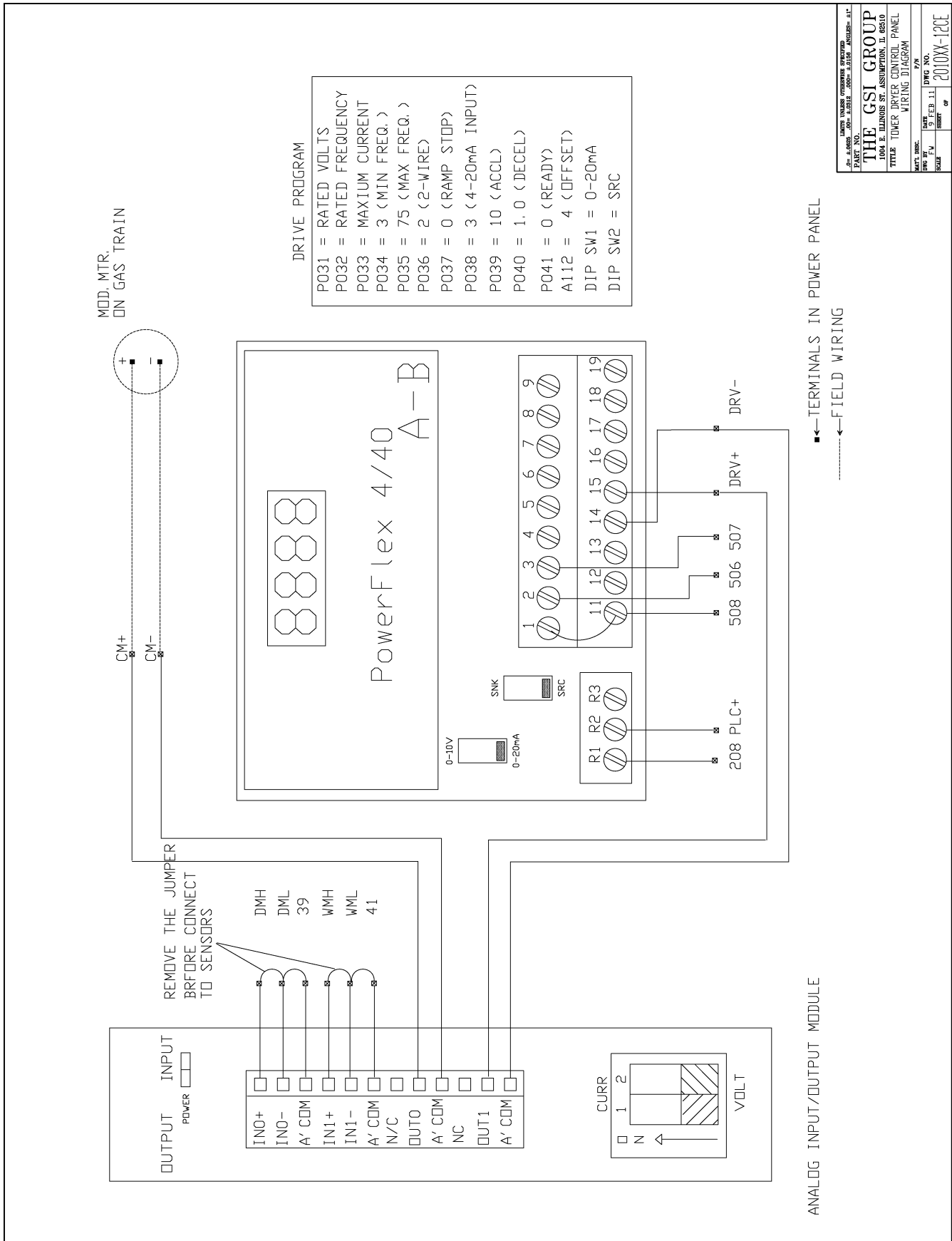

Figure 9R

9. Tower Dryer Control Panel Wiring Diagrams

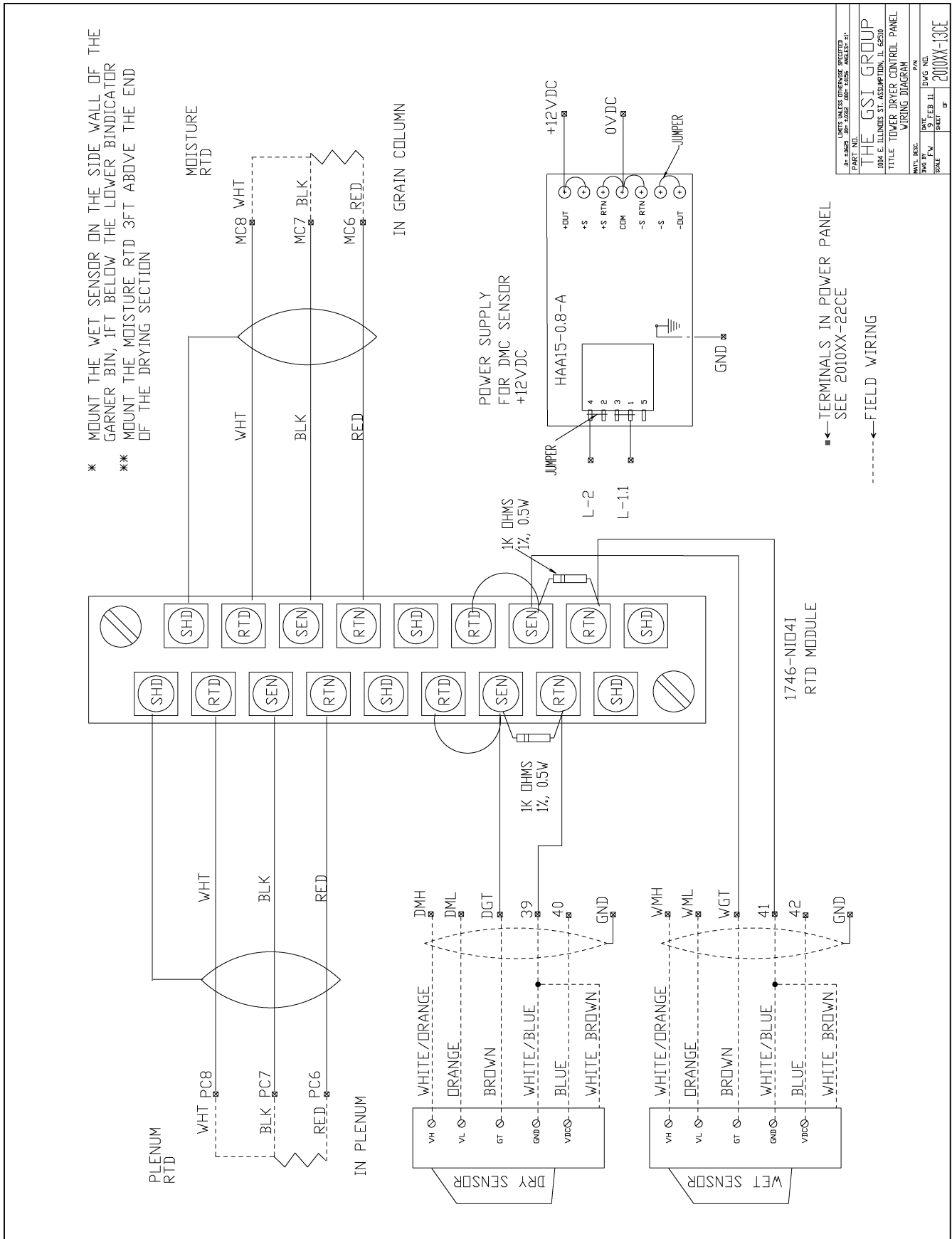
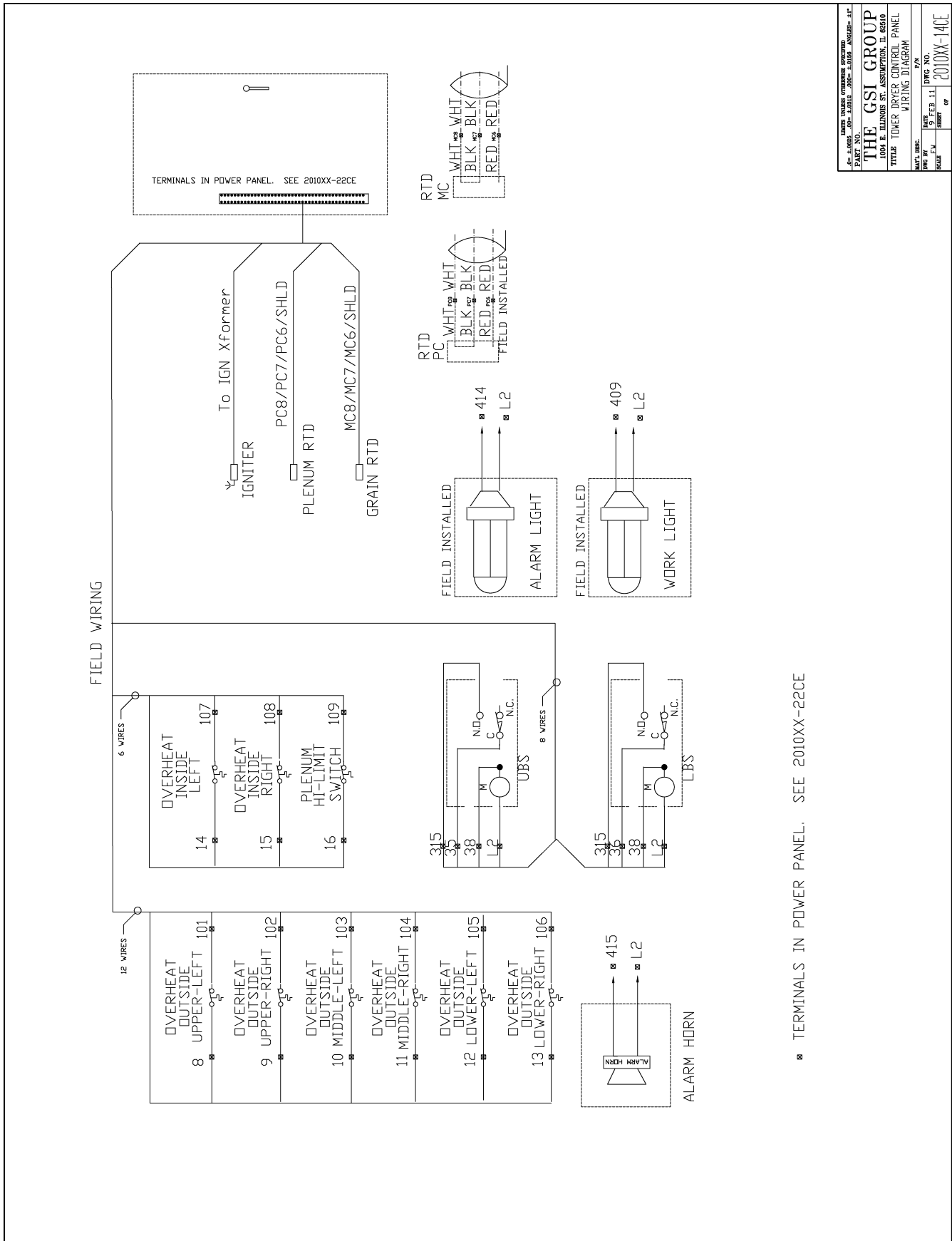

Figure 9S

9. Tower Dryer Control Panel Wiring Diagrams



<small>UNLESS OTHERWISE SPECIFIED ALL DIMENSIONS ARE IN INCHES UNLESS OTHERWISE SPECIFIED</small>	
THE GSI GROUP 1004 E. ILLINOIS ST., ASSUMPTION, IL 62610	
TITLE TOWER DRYER CONTROL PANEL WIRING DIAGRAM	
<small>MFG. NO.</small> 2010XX-14CE	<small>REV. NO.</small> 01
<small>DATE</small> 09 FEB 11	<small>BY</small> JCH
<small>SCALE</small> 1:1	<small>SHEET OF</small> 01

Figure 9T

9. Tower Dryer Control Panel Wiring Diagrams

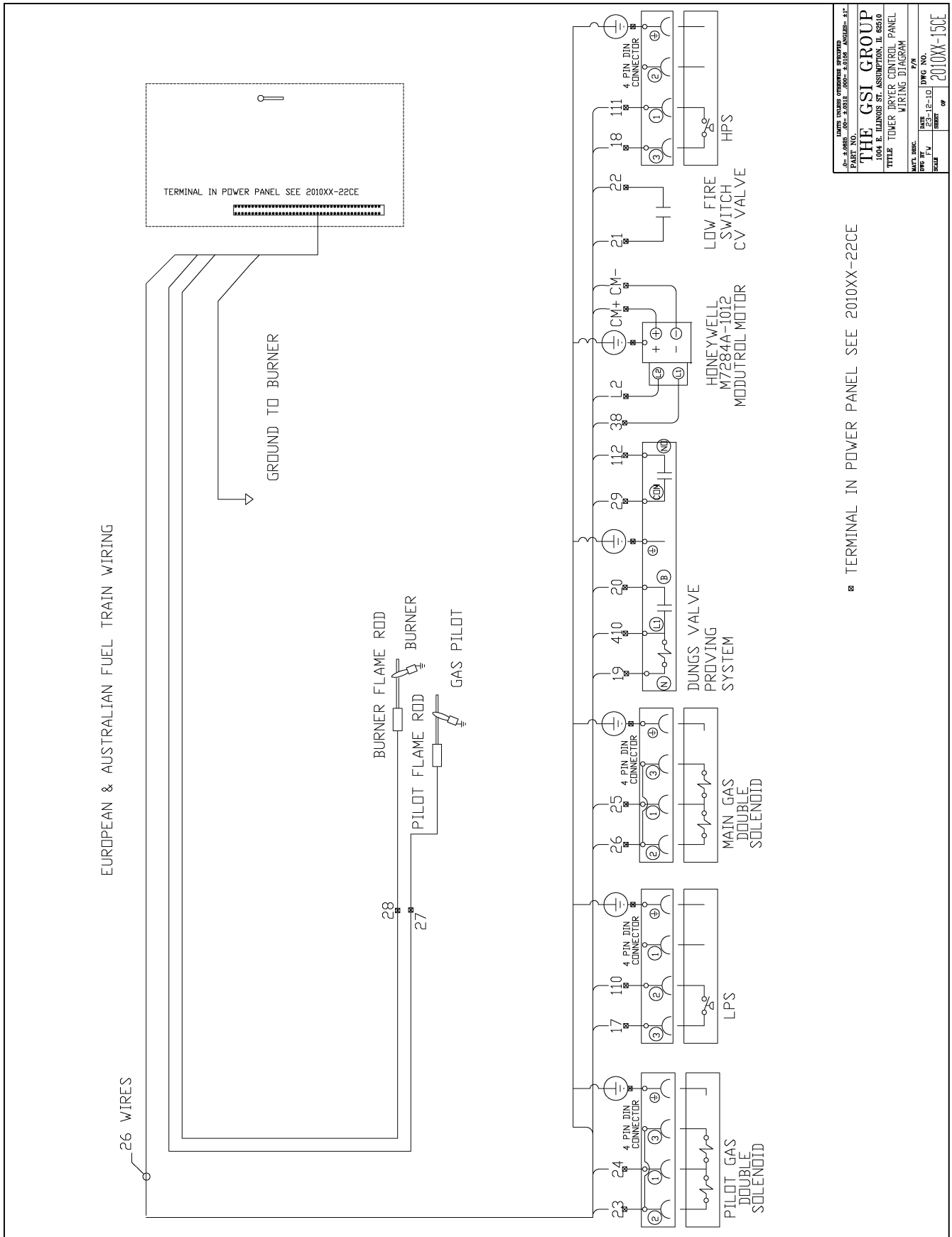

Figure 9U

9. Tower Dryer Control Panel Wiring Diagrams

LUNA INHIBIT OVERRIDE SPECIFICATIONS	
PLC NO.	PLC NO.
REV. NO.	REV. NO.
DATE	DATE
SCALE	SCALE
THE GSI GROUP 1004 E. TILGARD ST. ASSUMPTION, IL 62510 TITLE: TOWER DRYER CONTROL PANEL WIRING DIAGRAM 7/78 DATE: 9-FEB-11 DRAWN BY: J.M. CHECKED BY: J.M. 2010XX-16CE	

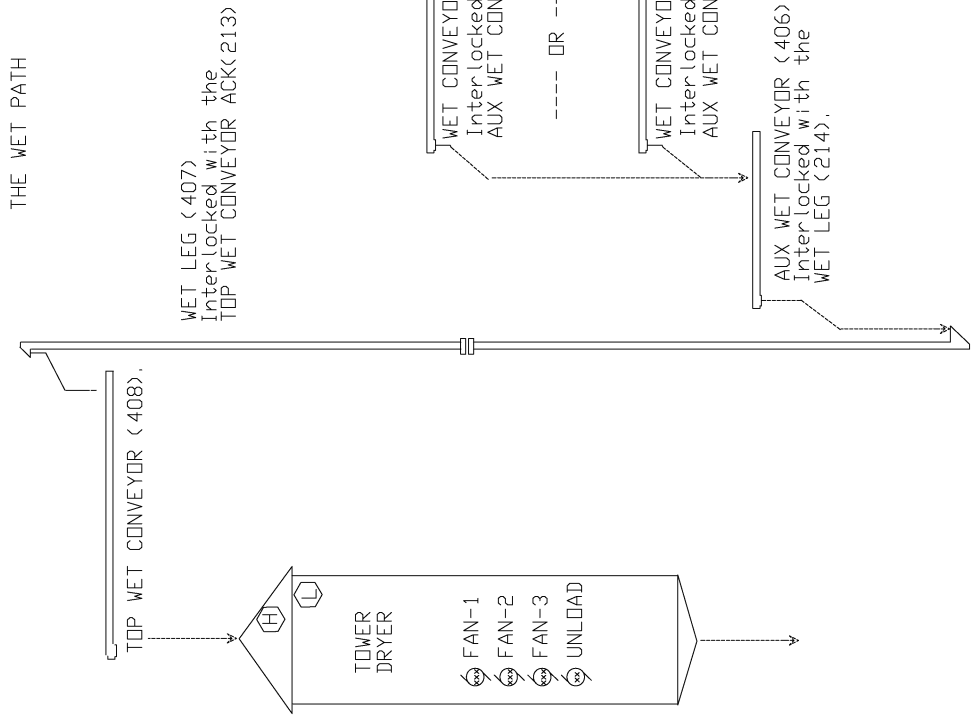
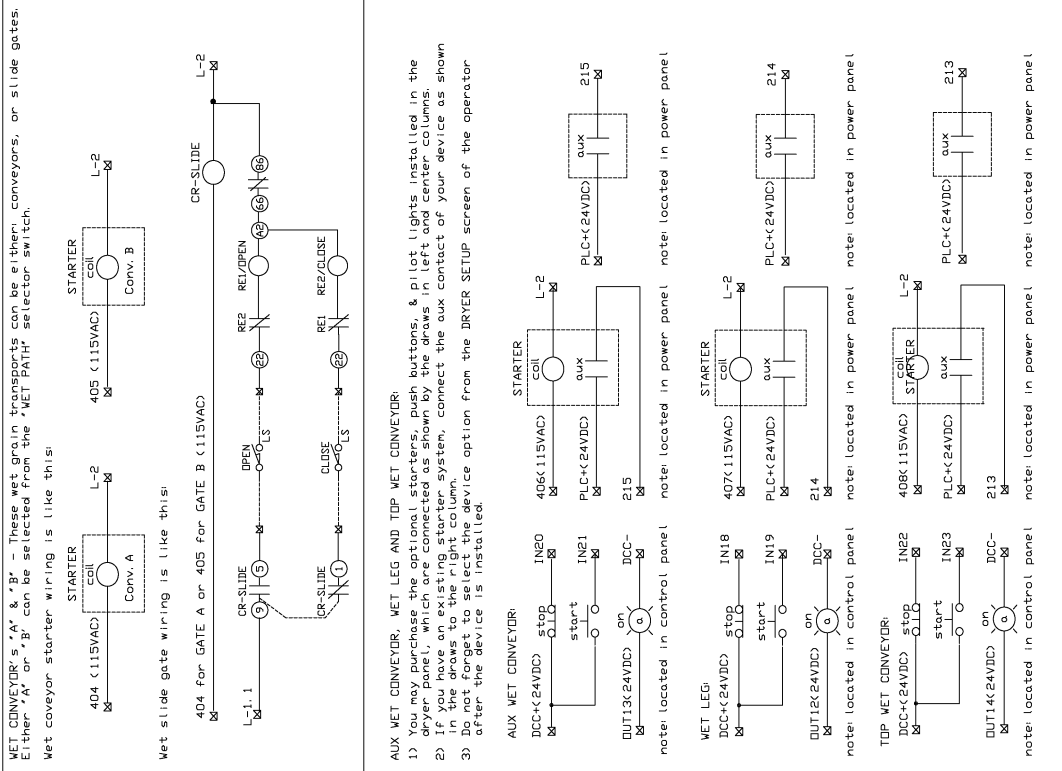

Figure 9V

9. Tower Dryer Control Panel Wiring Diagrams

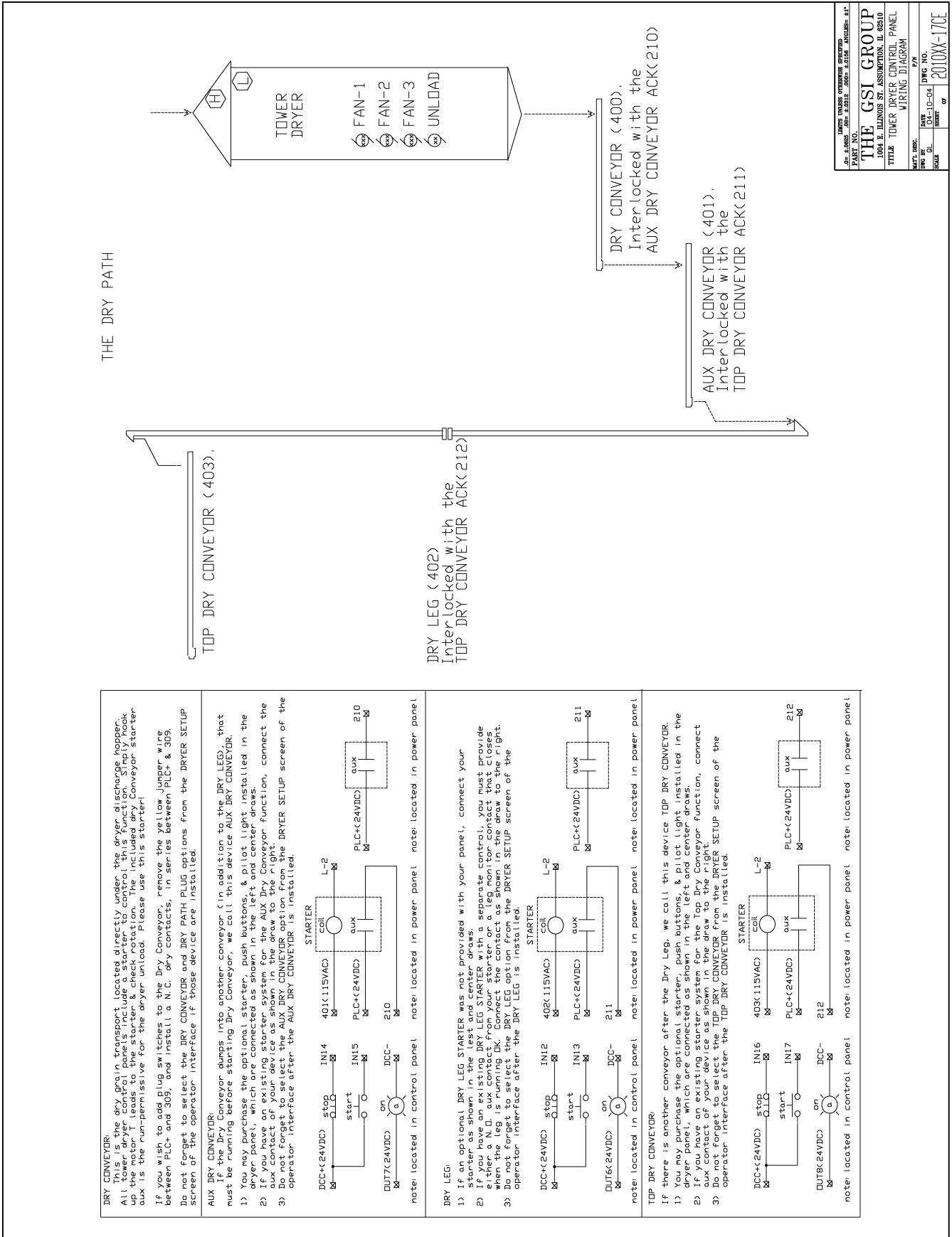

Figure 9W

<small>THE GSI GROUP 1004 E. ILLINOIS ST. ASSAULTON, IL 62610 P/78 DATE: 10-24-11 SCALE: 1:1</small>	
THE GSI GROUP	
TOWER DRYER CONTROL PANEL	
WIRING DIAGRAM	
<small>REV. NO.</small>	<small>DRY NO.</small>
<small>DATE</small>	<small>2010XX-170E</small>

9. Tower Dryer Control Panel Wiring Diagrams

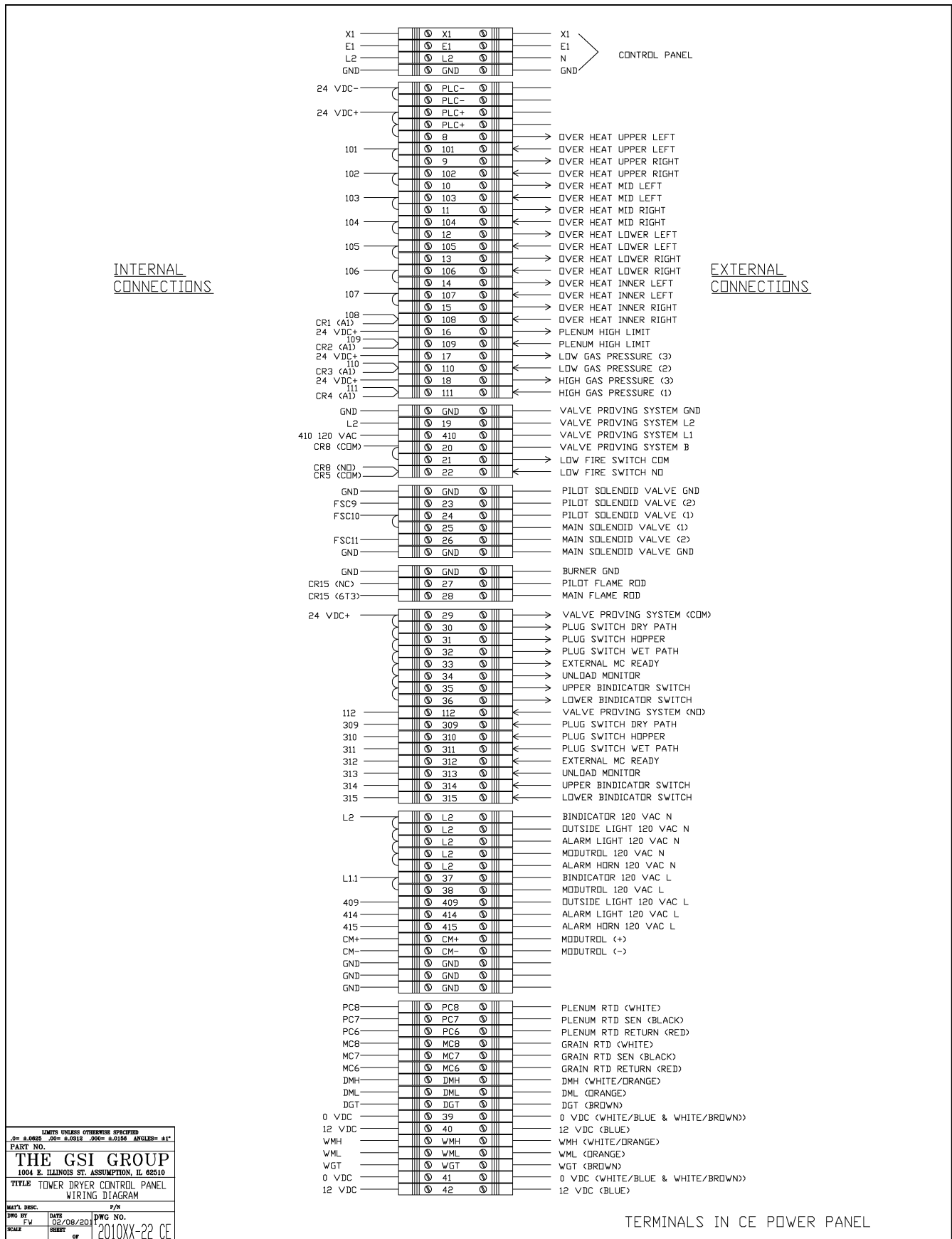
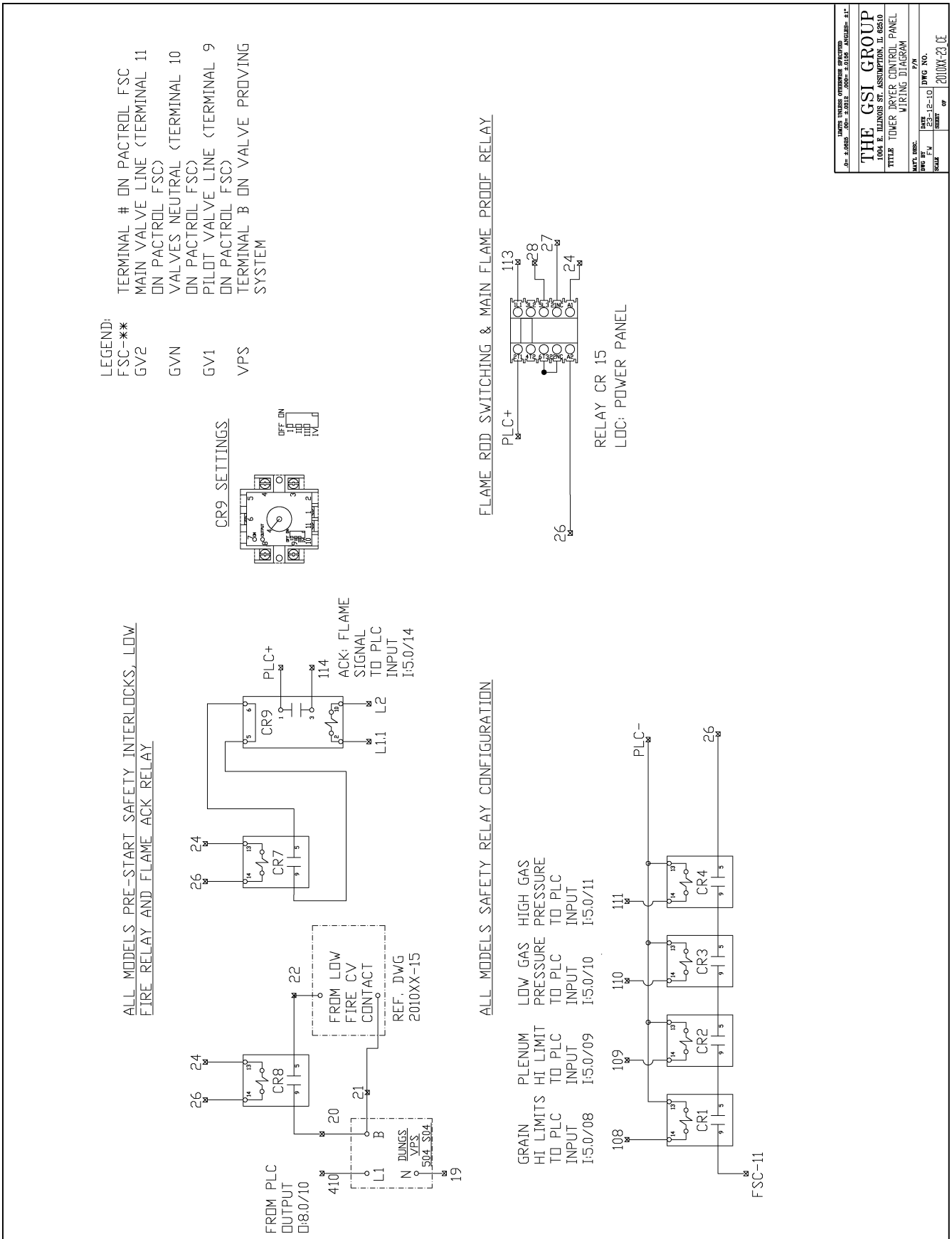

Figure 9X



<small>THE GSI GROUP 1004 E. ILLINOIS ST. ASSUMPTION, IL 62610 TEL: 618-938-1111 FAX: 618-938-1112 WWW.GSIGROUP.COM</small>	
THE GSI GROUP TOWER DRYER CONTROL PANEL WIRING DIAGRAM	
<small>DATE: 7/21/04 SCALE: 1:1</small>	<small>DWG NO.: 2010XX-23 CE</small>

Figure 9Y

9. Tower Dryer Control Panel Wiring Diagrams

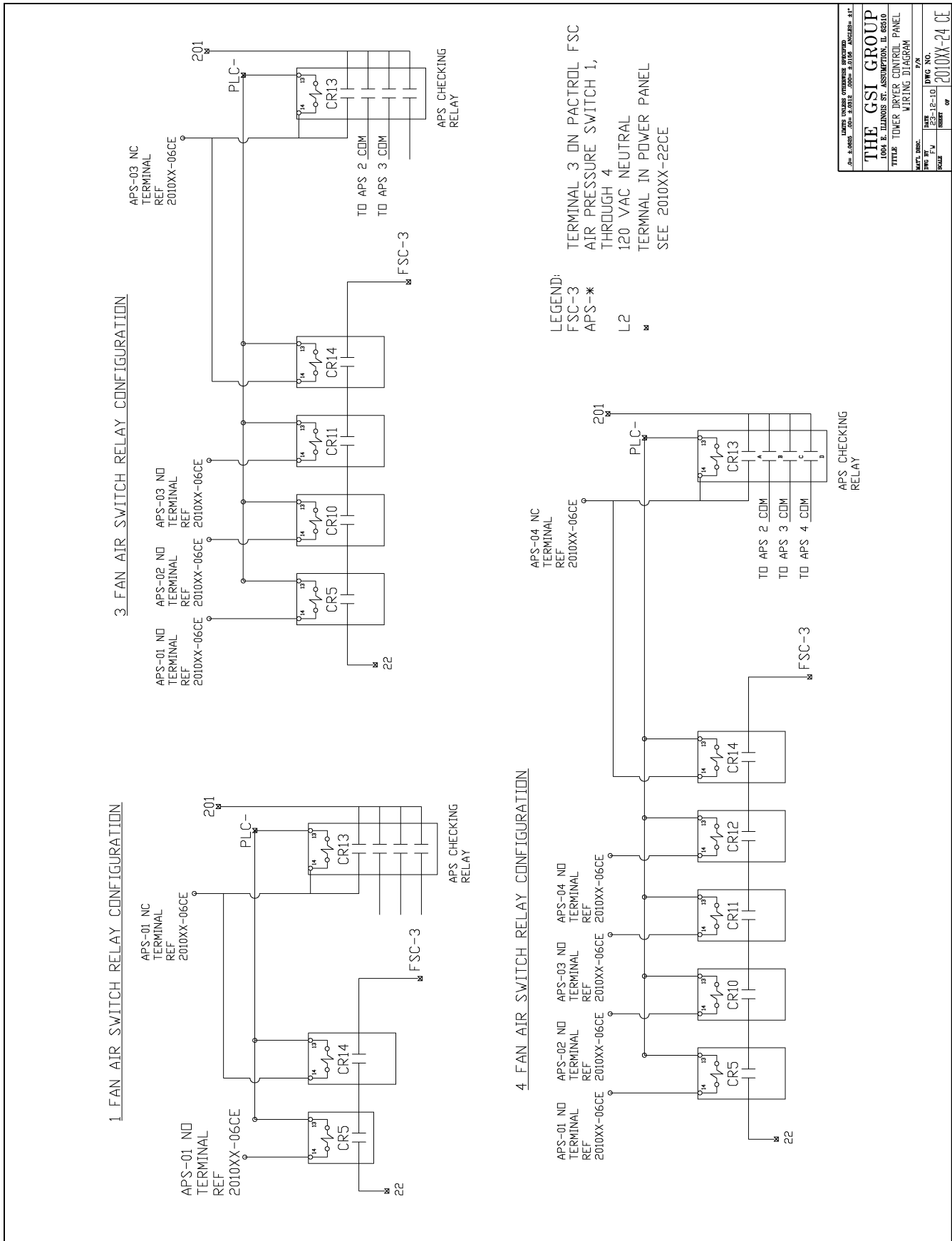

DATE: 08-01-12		DRAWN: J. J. J.		CHECKED: J. J. J.	
THE GSI GROUP					
1004 E. ILLINOIS ST., ASSUMPTION, IL 62510					
TITLE: TOWER DRYER CONTROL PANEL WIRING DIAGRAM					
DATE:	REV:	BY:	CHKD:	DATE:	REV:
08-01-12	1	J. J. J.	J. J. J.	08-01-12	1
SCALE:	1" = 1"	PROJECT NO.:		2010XX-24 CE	

Figure 9Z

GSI Group, LLC Limited Warranty

The GSI Group, LLC ("GSI") warrants products which it manufactures to be free of defects in materials and workmanship under normal usage and conditions for a period of 12 months after sale to the original end-user or if a foreign sale, 14 months from arrival at port of discharge, whichever is earlier. The end-user's sole remedy (and GSI's only obligation) is to repair or replace, at GSI's option and expense, products that in GSI's judgment, contain a material defect in materials or workmanship. Expenses incurred by or on behalf of the end-user without prior written authorization from the GSI Warranty Group shall be the sole responsibility of the end-user.

Warranty Extensions:

The Limited Warranty period is extended for the following products:

	Product	Warranty Period	
AP Fans and Flooring	Performer Series Direct Drive Fan Motor	3 Years	* Warranty prorated from list price: 0 to 3 years - no cost to end-user 3 to 5 years - end-user pays 25% 5 to 7 years - end-user pays 50% 7 to 10 years - end-user pays 75%
	All Fiberglass Housings	Lifetime	
	All Fiberglass Propellers	Lifetime	
Cumberland Feeding/Watering Systems	Feeder System Pan Assemblies	5 Years **	** Warranty prorated from list price: 0 to 3 years - no cost to end-user 3 to 5 years - end-user pays 50%
	Feed Tubes (1-3/4" and 2.00")	10 Years *	
	Centerless Augers	10 Years *	
	Watering Nipples	10 Years *	
Grain Systems	Grain Bin Structural Design	5 Years	
Grain Systems Farm Fans Zimmerman	Portable and Tower Dryers	2 Years	† Motors, burner components and moving parts not included. Portable dryer screens included. Tower dryer screens not included.
	Portable and Tower Dryer Frames and Internal Infrastructure †	5 Years	

GSI further warrants that the portable and tower dryer frame and basket, excluding all auger and auger drive components, shall be free from defects in materials for a period of time beginning on the twelfth (12th) month from the date of purchase and continuing until the sixtieth (60th) month from the date of purchase (extended warranty period). During the extended warranty period, GSI will replace the frame or basket components that prove to be defective under normal conditions of use without charge, excluding the labor, transportation, and/or shipping costs incurred in the performance of this extended warranty.

Conditions and Limitations:

THERE ARE NO WARRANTIES THAT EXTEND BEYOND THE LIMITED WARRANTY DESCRIPTION SET FORTH ABOVE. SPECIFICALLY, GSI MAKES NO FURTHER WARRANTY OF ANY KIND, EXPRESS OR IMPLIED, INCLUDING, WITHOUT LIMITATION, WARRANTIES OF MERCHANTABILITY OR FITNESS FOR A PARTICULAR PURPOSE OR USE IN CONNECTION WITH: (I) PRODUCT MANUFACTURED OR SOLD BY GSI OR (II) ANY ADVICE, INSTRUCTION, RECOMMENDATION OR SUGGESTION PROVIDED BY AN AGENT, REPRESENTATIVE OR EMPLOYEE OF GSI REGARDING OR RELATED TO THE CONFIGURATION, INSTALLATION, LAYOUT, SUITABILITY FOR A PARTICULAR PURPOSE, OR DESIGN OF SUCH PRODUCTS.

GSI shall not be liable for any direct, indirect, incidental or consequential damages, including, without limitation, loss of anticipated profits or benefits. The sole and exclusive remedy is set forth in the Limited Warranty, which shall not exceed the amount paid for the product purchased. This warranty is not transferable and applies only to the original end-user. GSI shall have no obligation or responsibility for any representations or warranties made by or on behalf of any dealer, agent or distributor.

GSI assumes no responsibility for claims resulting from construction defects or unauthorized modifications to products which it manufactured. Modifications to products not specifically delineated in the manual accompanying the equipment at initial sale will void the Limited Warranty.

This Limited Warranty shall not extend to products or parts which have been damaged by negligent use, misuse, alteration, accident or which have been improperly/inadequately maintained. This Limited Warranty extends solely to products manufactured by GSI.

Prior to installation, the end-user has the responsibility to comply with federal, state and local codes which apply to the location and installation of products manufactured or sold by GSI.

This equipment shall be installed in accordance with the current installation codes and applicable regulations which should be carefully followed in all cases. Authorities having jurisdiction should be consulted before installations are made.

G S I G R O U P



GSI Group
1004 E. Illinois St.
Assumption, IL 62510-0020
Phone: 1-217-226-4421
Fax: 1-217-226-4420
www.gsiag.com