



CE Approved T-Series Tower Dryer

Operation Manual

PNEG-1797

Date: 06-07-11

GSI GROUP



PNEG-1797

All information, illustrations, photos and specifications in this manual are based on the latest information available at the time of publication. The right is reserved to make changes at any time without notice.

Contents

Chapter 1 Safety	5
Safety Guidelines	5
Tower Dryer Operations and Service	6
Safety Precautions	6
Chapter 2 Decals	8
Chapter 3 Specifications	13
Electrical	13
Fuel	14
Dimensions	16
Chapter 4 Dryer Installation	19
Dryer Layout	19
Foundation	19
Standard Base for Models 1050, 1260, 1575, 1875 and 20100	20
Standard Base for Model 24100	21
Fuel Connections	22
Electrical Connection	22
Connecting Auxiliary Conveyors	22
Chapter 5 Operating Controls	23
Vision Control Panel Layout	23
Chapter 6 Vision Touch Screen Display	25
Select Data Log Sample Time	26
Optional Operation Screen	27
Setting the Timers	28
Setting the Temperatures	29
The Setup Screen	30
Viewing the Owner's Manuals on the Display Screen	33
Viewing the Dryer Shut Down History	34
Chapter 7 Dryer Start-Up	35
Dryer Commissioning	35
Pre-Season Checks	37
Chapter 8 Dryer Start-Up and Operation	44
Drying Temperatures	44
Initial Setup Parameters	44
Start-Up	44
Continuous Flow Drying Mode Using Advanced Moisture Control	45
How the Advanced Moisture Control Works	49
Chapter 9 Drying Time Tables	50
Chapter 10 Service	56
Pre-Seasonal Inspection and Service	56
Seasonal Inspection and Service	56
In Case of Fire	57
End of Season Service	57
Pre-Season Service Check List	58
End of Season Shut Down Procedure	58
Chapter 11 Lubrication	59
Chapter 12 Error Messages	60
Safety Circuit Shut Down Messages	60
Input/Output Generated Errors	61
Master Display Generated Errors	62

Table of Contents

Chapter 13 Wiring Diagrams	63
Earth Wiring	63
AC Control Wiring	64
12V DC Control Wiring	65
DC Power Wiring	66
24V Control Wiring	67
Flame Rod Wiring	68
Terminal Strip	69
Burner Control Safety Relay Schematic	70
Chapter 14 Warranty	71

Safety Guidelines

This manual contains information that is important for you, the owner/operator, to know and understand. This information relates to protecting **personal safety** and **preventing equipment problems**. It is the responsibility of the owner/operator to inform anyone operating or working in the area of this equipment of these safety guidelines. To help you recognize this information, we use the symbols that are defined below. Please read the manual and pay attention to these sections. Failure to read this manual and its safety instructions is a misuse of the equipment and may lead to serious injury or death.



This is the safety alert symbol. It is used to alert you to potential personal injury hazards. Obey all safety messages that follow this symbol to avoid possible injury or death.



DANGER indicates a hazardous situation which, if not avoided, will result in death or serious injury.



WARNING indicates a hazardous situation which, if not avoided, could result in death or serious injury.



CAUTION, used with the safety alert symbol, indicates a hazardous situation which, if not avoided, could result in minor or moderate injury.



NOTICE is used to address practices not related to personal injury.

Tower Dryer Operations and Service

This manual contains important information that all owners/operators must understand, relating to:

1. Personal safety.
2. Preventing equipment problems.

The owner/operator must inform anyone operating or working around this equipment of these safety guidelines.

Failure to read this manual and it's safety instructions is a misuse of the equipment and may lead to serious injury or death.

Safety Precautions

1. Read the operating manual.
2. Electrical installation must be in accordance with relevant IEC standards, EU Directives and Local Codes/Regulations.
3. The entire dryer must be electrically earthed.
4. Gas/liquid fuel supply must be in accordance with European Standards, EU Directives and Local Codes/Regulations.
5. **NEVER** operate the dryer without guards in place.
6. **DISCONNECT** and **LOCK OUT** all power and fuel before adjusting, servicing, accessing or entering the dryer or associated equipment.
7. **NEVER** bypass any safety device.
8. Whilst the dryer is running no-one should be inside or on the dryer.
9. Observe recommended drying temperatures.
10. Keep the dryer clean throughout.
11. Use **CAUTION**. The dryer and associated equipment may **START AUTOMATICALLY**.
12. Keep fan inlets clear of any foreign objects.
13. Auxiliary equipment capacity must be matched to the dryer.
14. Keep drive belts correctly tensioned.
15. Dry clean grain only for optimum performance.
16. Dryer operators must be trained and competent.
17. Follow required maintenance procedures and intervals.

Use Caution in the Operation of this Equipment

This dryer is designed and manufactured with operator safety in mind. However, the very nature of a grain dryer having a gas burner, high voltage electrical equipment and high speed rotating parts, presents hazards to personnel which cannot be completely safeguarded against without interfering with the efficient operation of the dryer and reasonable access to its components.

Use extreme caution in working around high speed fans, gas-fired heaters, augers and auxiliary conveyors, which may start without warning when the dryer is operating on automatic control.



Keep the dryer clean. Do not allow fine material to accumulate in the plenum chamber or surrounding the outside of the dryer.

Continued safe, dependable operation of automatic equipment depends, to a great degree, upon the owner. For a safe and dependable drying system, follow the recommendations within the Owner's Manual and make it a practice to regularly inspect the unit for any developing problems or unsafe conditions.

Take special note of the safety precautions [on Page 6](#) before attempting to operate the dryer.

2. Decals

Safety decals must be read and understood by all people in and around the dryer area. If any safety decals are not displayed on the dryer or if they are damaged, contact The GSI Group, Inc. for replacement:

Decals

1004 E. Illinois St.
Assumption, IL. 62510
Phone: 1-217-226-4421

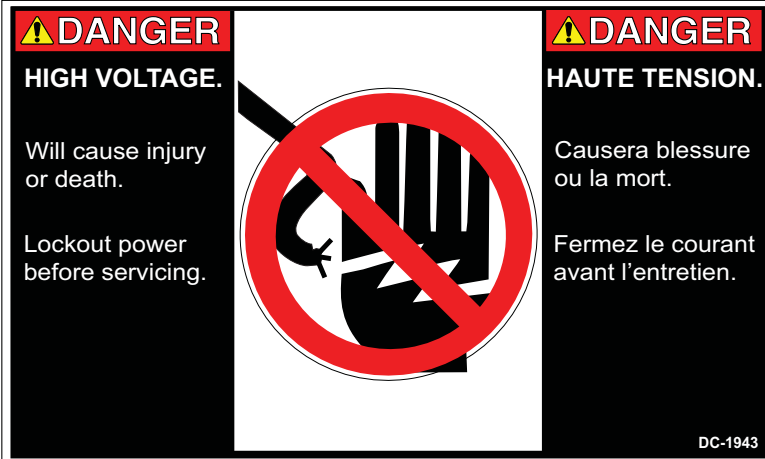

DC-1943

Background: White
Colors: Black, ANSI Yellow (Pantone 108C) and Safety Red (PMS 179C)
Size: 5.000" x 3.000"

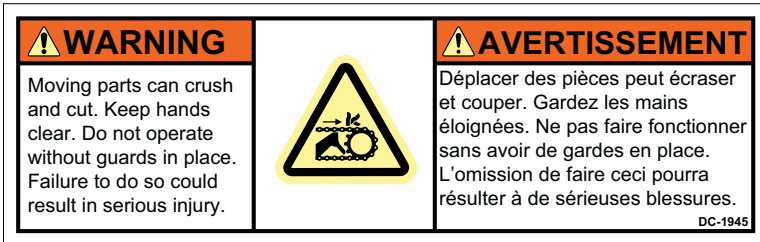

DC-1945

Background: White
Colors: Black, Safety Orange (PMS 152C) and Safety Yellow (PMS 109C)
Size: 4.375" x 1.500"

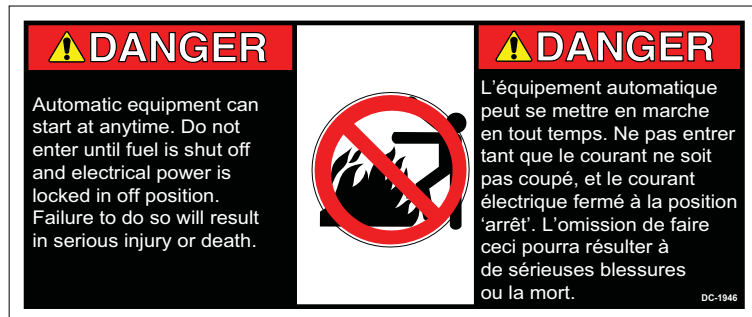

DC-1946

Background: White
Colors: Black, ANSI Yellow (Pantone 108C) and Safety Red (PMS 179C)
Size: 4.375" x 1.500"

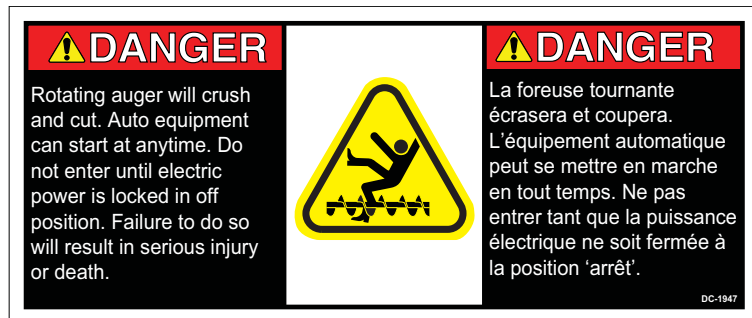

DC-1947

Background: White
Colors: Black, ANSI Yellow (Pantone 108C) and Safety Yellow (PMS 109C)
Size: 4.375" x 1.375"

<p>⚠ DANGER HIGH VOLTAGE. Will cause serious injury or death. Lockout power before servicing.</p>		<p>⚠ DANGER HAUTE TENSION Causera de sérieuses blessures ou la mort. Vérouillez le courant avant l'entretien.</p>
--	---	--

DC-1948

Background: White
 Colors: Black, ANSI Yellow (Pantone 108C) and Safety Red (PMS 179C)
 Size: 4.375" x 1.375"



DANGER



CONFINED SPACE
ESPACE HORS LIMITE

AUTHORIZED PERSONNEL ONLY
PERSONNEL AUTORISÉ SEULEMENT

DC-1961

Background: White
 Colors: Black, White and Safety Red (RGB FF000)
 Size: 7.000" x 5.000"

<p>⚠ DANGER AMPUTATION HAZARD. Rotating drum below. Will cause serious injury or death. LOCKOUT power before entering or servicing.</p>		<p>⚠ DANGER RISQUE D'AMPUTATION. Tambour rotatif ci-dessous. Cause de sérieuses blessures ou la mort. Éteindre le courant avant d'entrer ou de faire l'entretien.</p>
---	---	---

DC-2020

Background: White
 Colors: Black, ANSI Yellow (Pantone 108C) and Safety Red (PMS 179C)
 Size: 5.000" x 3.000"

<p>⚠ WARNING Flame and pressure beyond door. May cause serious injury. Do not enter when dryer is running.</p>		<p>⚠ AVERTISSEMENT Pression et flamme au-delà de cette porte. Peut causer des blessures sérieuses. Ne pas entrer quand le séchoir est en marche.</p>
--	---	--

DC-2021

Background: White
 Colors: Black, Safety Orange (PMS 152C) and Safety Yellow (PMS 109C)
 Size: 4.875" x 3.000"

2. Decals

<p>⚠ DANGER</p> <p>DO NOT STAND ON DRUM!</p> <p>Rotating drum will cause serious injury or death.</p> <p>Disconnect power before servicing.</p>		<p>⚠ DANGER</p> <p>NE PAS SE METTRE DEBOUT SUR LE TAMBOUR!</p> <p>Le tambour rotatif causera de sérieuses blessures ou la mort.</p> <p>Débranchez le courant avant de faire l'entretien.</p>
DC-2022		

DC-2022

Background: White
 Colors: Black, ANSI Yellow (Pantone 108C) and Safety Red (PMS 179C)
 Size: 5.000" x 3.000"

<p>⚠ CAUTION</p> <p>Airborne particles during operation. May impair vision and breathing. Do not enter when dryer is running.</p>		<p>⚠ ATTENTION</p> <p>Particules en suspension durant le fonctionnement. Peut affecter la vision et la respiration. Ne pas entrer quand le séchoir est en marche.</p>
DC-2023		

DC-2023

Background: White
 Colors: Safety Yellow (FFFF99) and Black
 Size: 9.000" x 3.000"

<p>⚠ WARNING</p> <p>High speed belt drive operating overhead. Can cause serious injury. Keep head and hands clear. Do not enter when dryer is running.</p>		<p>⚠ AVERTISSEMENT</p> <p>Poulie à courroie de haute vitesse au-dessus de la tête. Peut causer de sérieuses blessures. Gardez la tête et les mains éloignées. Ne pas entrer quand le séchoir est en marche.</p>
DC-2024		

DC-2024

Background: White
 Colors: Black, Safety Orange (PMS 152C) and Safety Yellow (PMS 109C)
 Size: 4.875" x 3.000"

<p>⚠ CAUTION</p> <p>Crush Hazard. Secure legs to foundation prior to opening doors. Serious injury could result.</p>		<p>⚠ ATTENTION</p> <p>Risque de se faire écraser. Stabilisez les jambes à la fondation avant d'ouvrir les portes. De sérieuses blessures peuvent se produire.</p>
DC-2026		

DC-2026

Background: White
 Colors: Safety Yellow (FFFF99) and Black
 Size: 9.000" x 3.000"

<p>! WARNING</p> <p>SLIPS AND FALLS</p> <p>can cause severe injuries.</p> <p>Do NOT step or stand in this area.</p>		<p>! AVERTISSEMENT</p> <p>GLISSER ET TOMBER</p> <p>peut causer de sérieuses blessures.</p> <p>Ne PAS enjamber ou se tenir debout dans cette zone.</p> <p>DC-2031</p>	<p>DC-2031</p> <p>Background: White Colors: Black, Safety Orange (PMS 152C), Safety Red and Safety Yellow (FFFF99) Size: 4.875" x 3.000"</p>
<p>! WARNING AVERTISSEMENT</p> <p>If an overload or a fault current interruption occurs, circuits must be checked to determine the cause of the interruption. If a fault condition exists, the current-carrying components should be examined and replaced if damaged, and the integral current sensors must be replaced to reduce the risk of fire or electric shock.</p> <p>Si une interruption de surcharge ou de courant fautif se produisent, les circuits doivent être vérifiés pour déterminer la cause de cette interruption. Si une condition fautive existe, les composants transportant le courant doivent être vérifiées et remplacées si endommagées. Les détecteurs de courant intégral doivent être remplacés pour réduire le risque de feu ou de choc électrique.</p> <p>DC-2033</p>			<p>DC-2033</p> <p>Background: White Colors: Black, Safety Orange (PMS 152C) and Safety Yellow (PMS 108C) Size: 4.000" x 3.000"</p>
<p>! WARNING AVERTISSEMENT</p> <p>To maintain overcurrent short circuit and ground fault protection, the manufacturer's instructions for selecting overload relays and setting the instantaneous trip circuit breaker must be followed.</p> <p>Pour maintenir la protection de surcharge d'un court circuit ou de mise à la terre, les instructions du fabricant doivent être suivies en ce qui concerne la sélection des relais de surintensité et le positionnement du disjoncteur de déclenchement instantané.</p> <p>DC-2037</p>			<p>DC-2037</p> <p>Background: White Colors: Black, Safety Orange (PMS 152C) and Safety Yellow (PMS 108C) Size: 3.000" x 2.500"</p>

2. Decals



WARNING AVERTISSEMENT

Insure that the incoming AC power and all separate power sources are turned off and locked before working on this equipment. Failure to observe this practice may result in severe injury, death, and/or equipment damage.

S'assurer que la puissance AC venant de l'extérieur et toutes autres sources de puissance indépendantes soient en arrêt et bloquées avant de travailler sur cet équipement. L'omission d'observer cette pratique peut résulter à des blessures sévères, la mort et/ou des dommages à l'équipement.

DC-2038

DC-2038

Background: White

Colors: Black, Safety Orange (PMS 152C) and Safety Yellow (PMS 108C)

Size: 3.000" x 3.000"



WARNING AVERTISSEMENT

All maintenance procedures must be performed by qualified personnel who are familiar with the operation of this equipment. Failure to observe this warning can result in serious or even fatal injury and/or equipment damage.

Toutes les procédures d'entretien doivent être exécutées par un personnel qualifié étant familier avec le fonctionnement de cet équipement. L'omission d'observer cet avertissement peut résulter à des blessures sérieuses et même mortelles. Peut aussi causer des dommages à l'équipement.

DC-2039

DC-2039

Background: White

Colors: Black, Safety Orange (PMS 152C) and Safety Yellow (PMS 108C)

Size: 3.000" x 3.000"

Be sure that charge light and all LED's are out before touching any componenets.

Soyez assuré que la lumière de charge et toutes les LED soient fermés avant de toucher tout composants.

All test equipment should be connected and disconnected with power off.

Tout l'équipement de test devrait être branché et débranché quand tout est éteint.

Grounded test equipment, such as oscilloscopes, may damage the inverter.

L'équipement de test de mise à la terre, tel que les oscilloscopes, peut endommager l'onduleur de courant.

Isolate all instruments from ground before using. The DC bus remains charged for several minutes after power is removed.

Isoler tous les instruments au sol avant d'utiliser. Le DC bus reste chargé durant plusieurs minutes suivant la mise en arrêt de la puissance.

DC-2040

DC-2040

Background: White

Colors: Black and White

Size: 5.500" x 3.500"



DANGER



Rotating flighting will kill or dismember.
Les vols rotatifs causeront la mort ou démembrera.



Flowing material will trap and suffocate.
Le matériel flottant vous coincera et causera la suffocation.



Crusted material will collapse and suffocate.
Le matériel croûté s'effondra et causera la suffocation.

Keep clear of all augers.

DO NOT ENTER this bin!

Restez éloigné de toutes les tarières.

NE PAS ENTRER dans ce silo!

If you must enter this bin:

Si vous devez entrer dans ce silo:

1. Shut off and lock out all power.
1. Fermez et bloquez toutes la puissance de courant.
2. Use a safety harness and safety line.
2. Utilisez un harnais et une ligne de sécurité.
3. Station another person outside the bin.
3. Postez une autre personne à l'extérieur du silo.
4. Avoid the center of the bin.
4. Évitez le centre du silo.
5. Wear proper breathing equipment or respirator.
5. Portez un équipement de respiration ou un masque respiratoire approprié.

Failure to heed these warnings will result in serious injury or death.
L'omission de tenir compte de ces avertissements résultera à de sérieuses blessures ou la mort.

DC-2041

DC-2041

Background: White

Colors: Black, ANSI Yellow (Pantone 108C) and Safety Red (PMS 179C)

Size: 8.500" x 11.000"

Dryer Specifications

Models	1050	1260	1575	1875	20100	24100
Blower Size	43" Axial	43" Axial	8490	8542	8542	8600
Blower RPM	1750	1750	1035	856	981	818
Blower kW	37.50	45.00	56.25	56.25	75.00	75.00
Metering kW	0.75	0.75	0.75	0.75	0.75	0.75
Drying m ³ /s	19.98	22.86	36.42	38.63	46.57	51.15
Cooling m ³ /s	6.85	8.27	18.21	19.32	23.28	25.58
Grain Column	324 mm	324 mm	324 mm	324 mm	324 mm	324 mm
Tower Diameter	3.65 m	3.65 m	3.65 m	3.65 m	3.65 m	3.65 m
Overall Height	13.9 m	15.9 m	18.0 m	21.0 m	23.1 m	26.1 m
Wet Holding (T)	7.67	7.67	7.67	7.67	7.67	7.67
Heat Holding (T)	15.49	19.20	23.22	29.41	31.90	38.07
Cool Holding (T)	5.56	6.81	7.75	8.99	11.46	12.70
Dryer Holding (T)	31.29	36.25	41.20	48.64	53.59	60.99
Outside Catwalks	0	0	1	2	2	3
T/H (20%-15%)	25	30	38	46	51	61
T/H (25%-15%)	15	18	23	27	30	37

Electrical

Standard voltages are:

1. 240V, 480V or 575V, 60 Hz
2. 380V-400V, 50 Hz

The power panel includes:

1. Main power disconnect.
2. Motor starters and overloads (standard direct on line, star/delta and soft start are options).
3. Control circuit breakers for the individual blower motors.
4. Auxiliary 7.5 kW motor starters for dry and wet grain handling equipment.
5. A correctly designed power supply is required, including safety earth connection.

3. Specifications

Electrical Power Requirements

3 Phase Power Requirements (A)							
Supply Voltage	230	380	400	415	440	460	575
Model #							
T-1050	204	123	117	113	106	102	81
T-1260	226	136	130	125	118	113	90
T-1575	258	156	148	143	135	129	103
T-1875	258	156	148	143	135	129	103
T-20100	316	191	181	175	165	158	126
T-24100	316	191	181	175	165	158	126
F-1050	204	123	117	113	106	102	81
F-1260	226	136	130	125	118	113	90
F-1575	258	156	148	143	135	129	103
F-1875	258	156	148	143	135	129	103
F-20100	316	191	181	175	165	158	126
F-24100	316	191	181	175	165	158	126

Fuel

1. Fuel types are propane or natural gas vapor.
2. Minimum supply pressure is,
 - a. 450 mBar natural gas at full burner flow rate.
 - b. 700 mBar propane vapor at full burner flow rate.
3. Burner flow rates are as table on [Page 15](#).

T-Series and F-Series Fuel Specifications

T-Series and F-Series	T/F-1050	T/F-1260	T/F-1575	T/F-1875	T/F-1054	T/F-20100	T/F-24100
Maximum Burner Output (kW)	3254	3831	4882	5180	6244	6858	7722
Average Burner Output (kW)	1871	2203	2807	2979	3590	3943	4440
LPG Fuel	LPG Gross CV		93.8 MJ/m³				
Maximum Gas Flow LPG (m ³ /h)	125	147	187	199	240	263	296
Average Gas Flow LPG (m ³ /h)	72	85	108	114	138	151	170
Supply Pressure mBar ¹	350-700	350-700	350-700	350-700	350-700	350-700	350-700
Regulator Setting mBar ²		206	206	206	206	206	206
Regulator Spring	Black	Cadmium	Cadmium	Cadmium	Cadmium	Cadmium	Cadmium
Burner Pressure High-Fire mm H ₂ O ⁶		418	1375	807	1189	1447	972
Burner Pressure Low-Fire mm H ₂ O ⁷		16.7	55.0	32.3	47.5	57.9	38.9
Natural Gas Fuel	NG Gross CV		39 MJ/m³				
Maximum Gas Flow NG (m ³ /h)	303	357	455	483	582	640	720
Average Gas Flow NG (m ³ /h)	174	205	262	278	335	368	414
Supply Pressure mBar ¹	350-700	350-700	350-700	350-700	350-700	350-700	350-700
Regulator Setting mBar ²	21	206	206	206	206	206	206
Regulator Spring	Black	Cadmium	Cadmium	Cadmium	Cadmium	Cadmium	Cadmium
Burner Pressure High-Fire mm H ₂ O ⁶		719	1189	697	1009	1241	855
Burner Pressure Low-Fire mm H ₂ O ⁷		28.8	47.6	27.9	40.3	49.7	34.2
Pressure Relief Set Point mBar ⁴	500	500	500	500	500	500	500
Over Pressure Valve Set Point mBar ⁵	450	450	450	450	450	450	450

3. Specifications

Dimensions

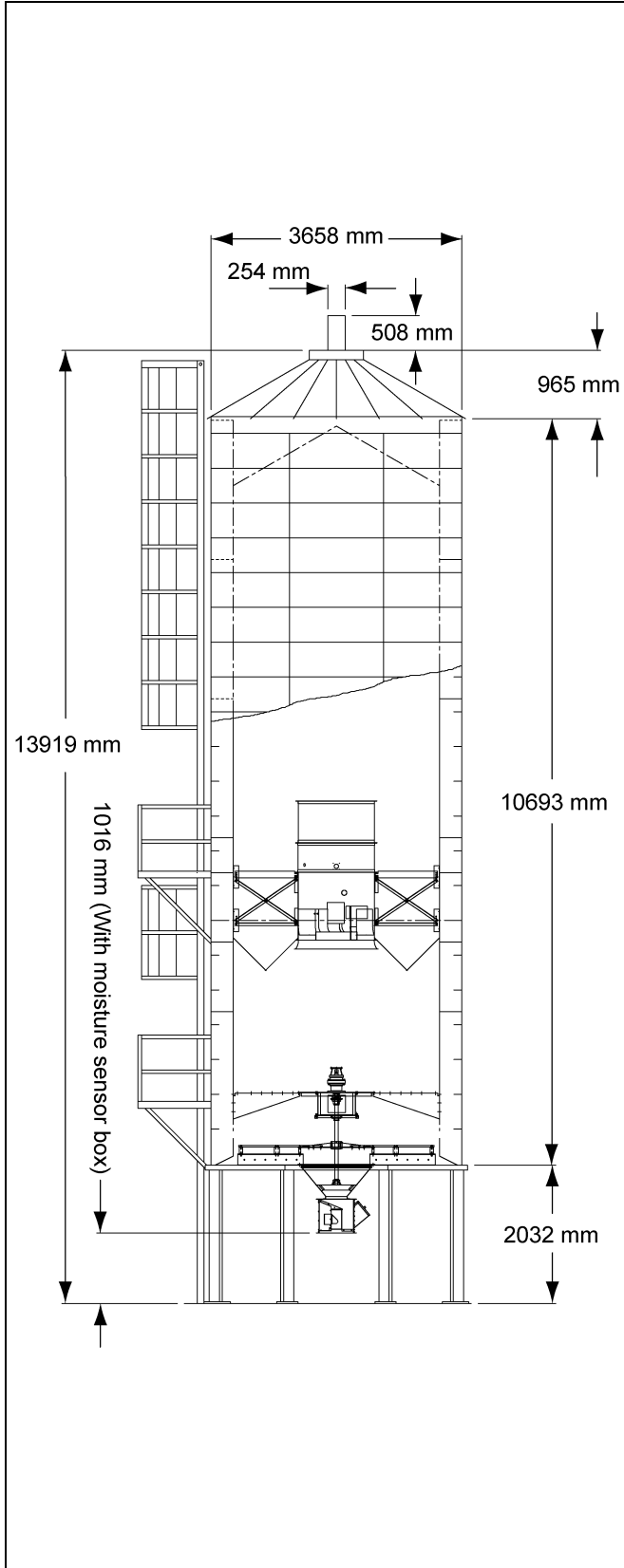

Figure 3A 1050

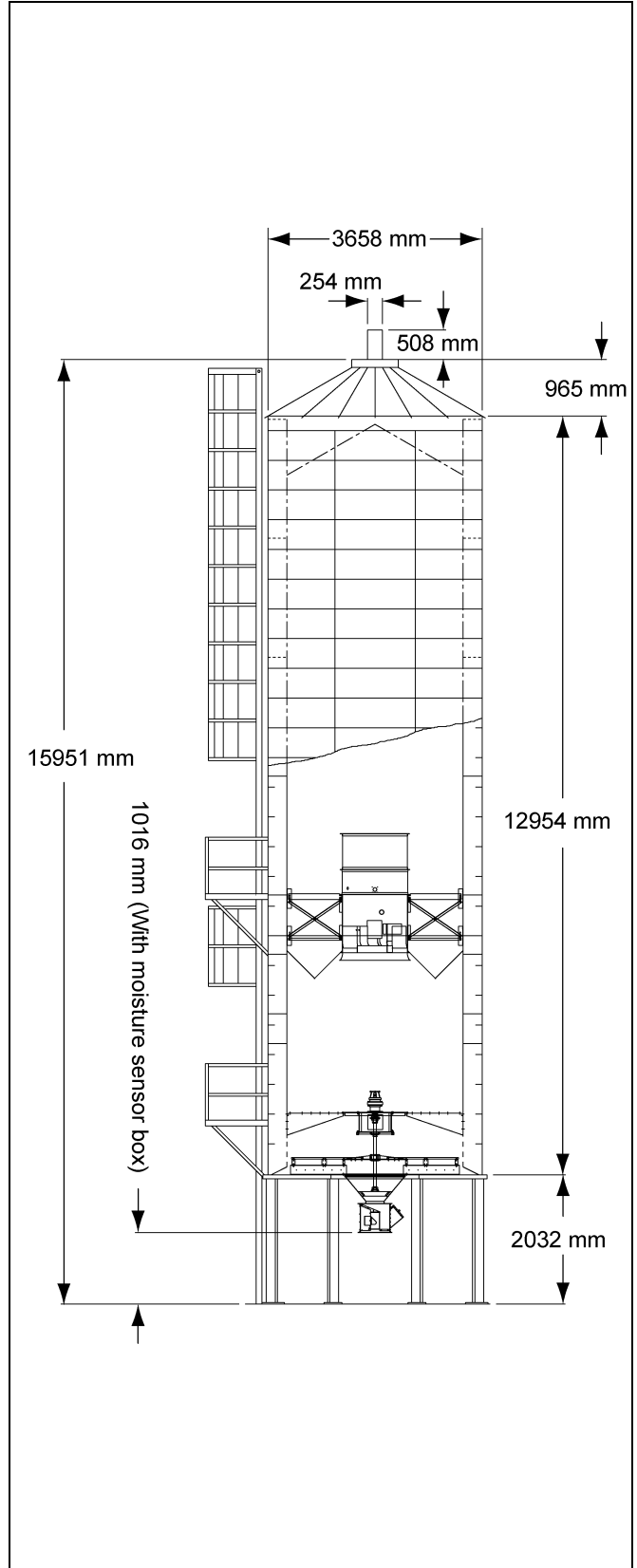

Figure 3B 1260

Dimensions (Continued)

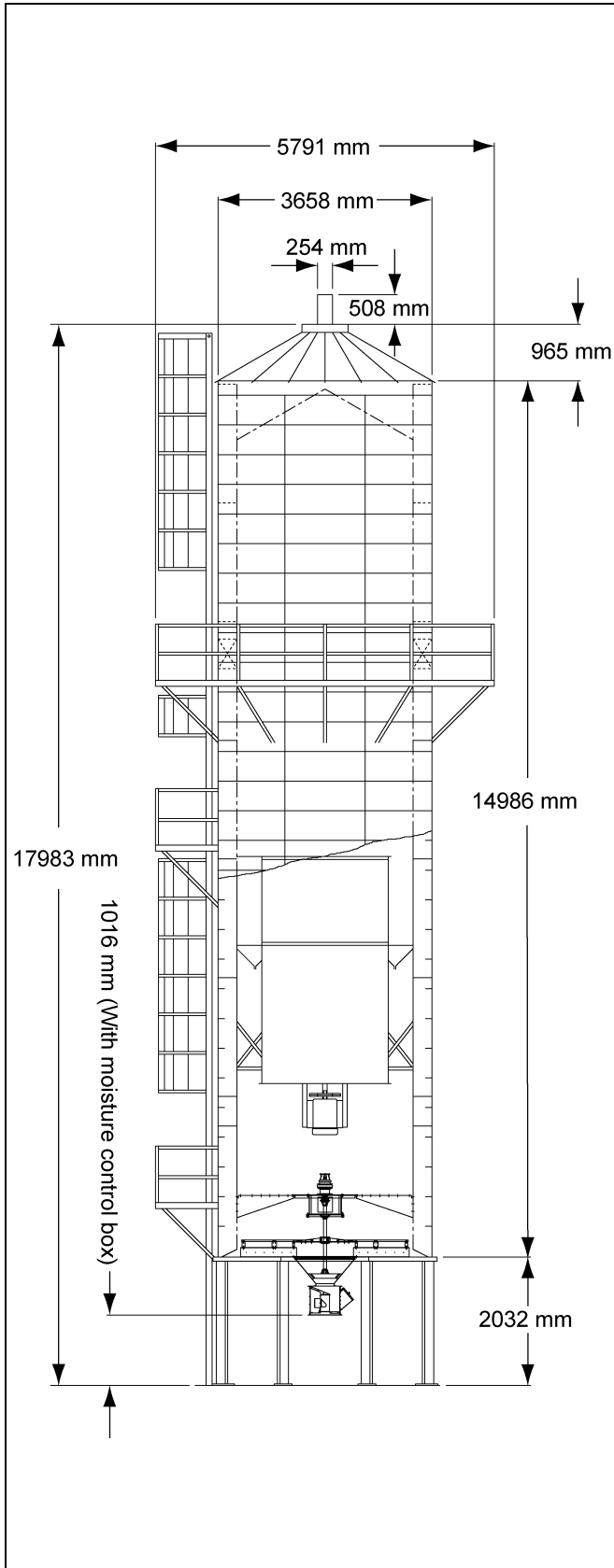

Figure 3C 1575

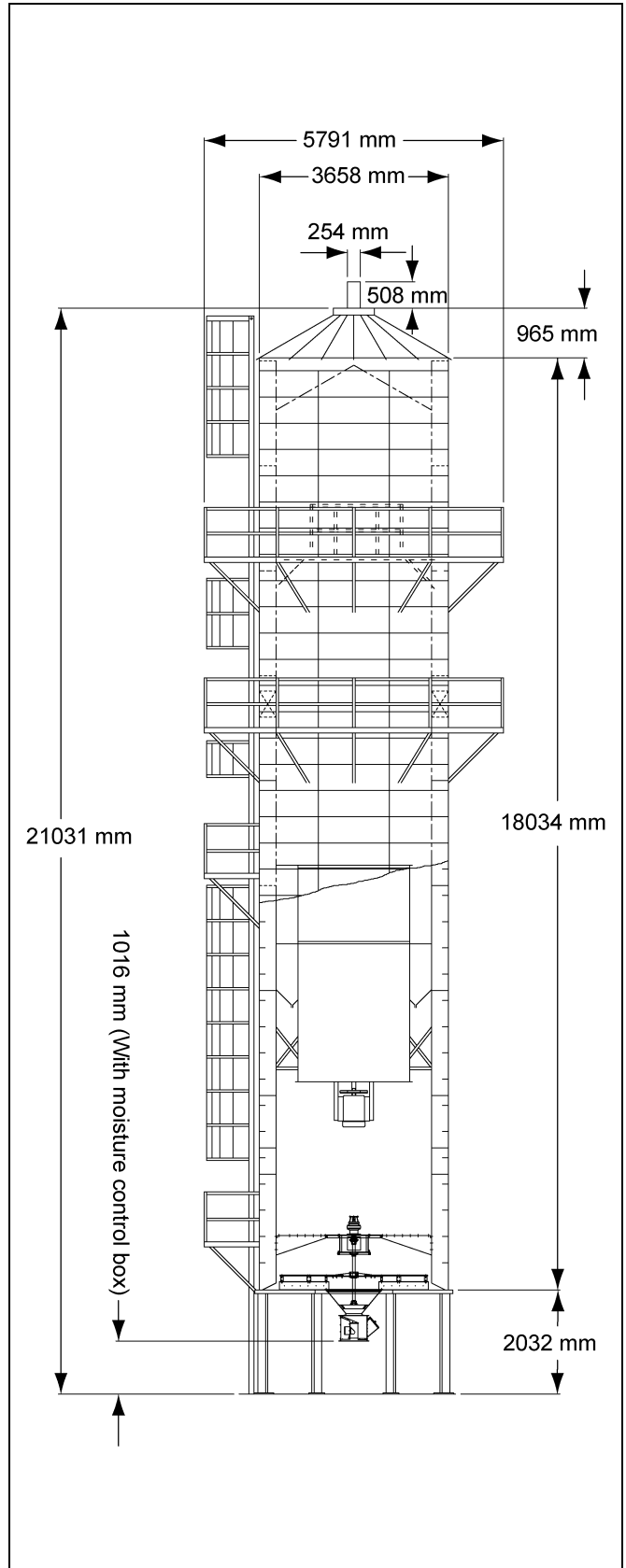

Figure 3D 1875

3. Specifications

Dimensions (Continued)

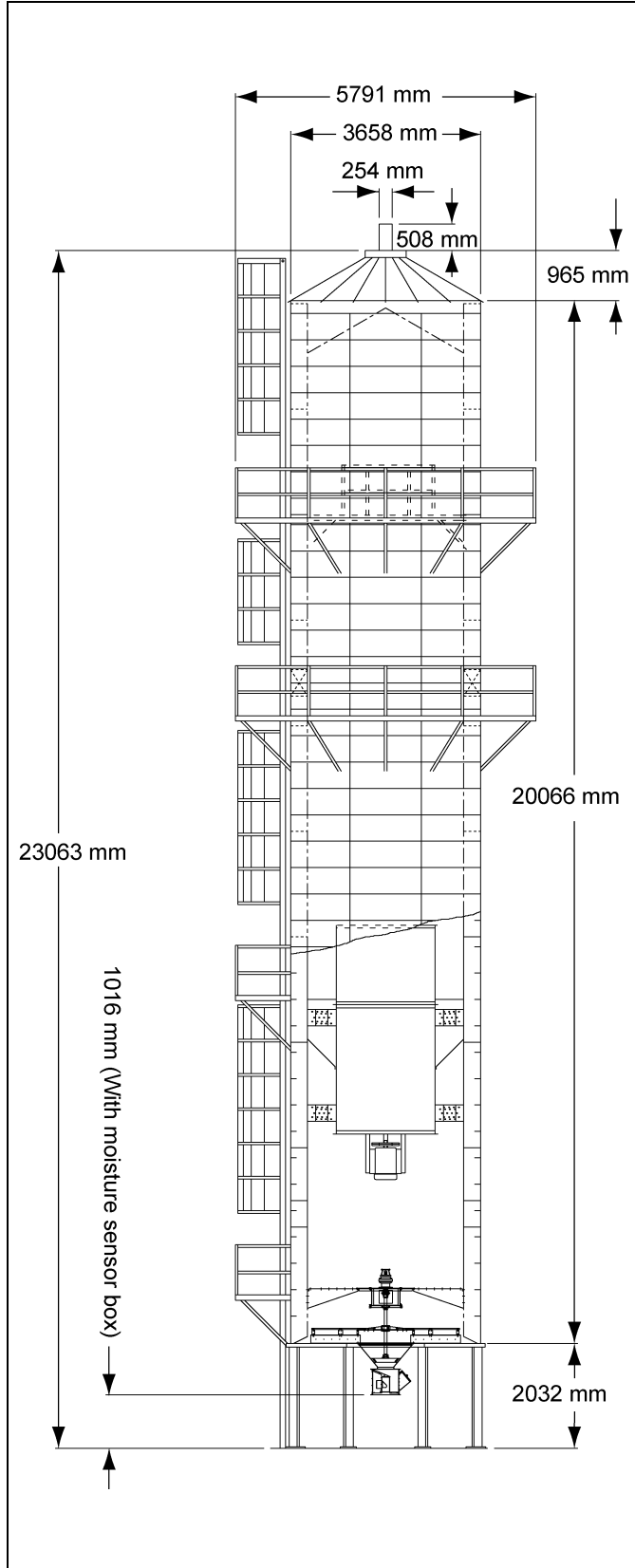

Figure 3E 20100

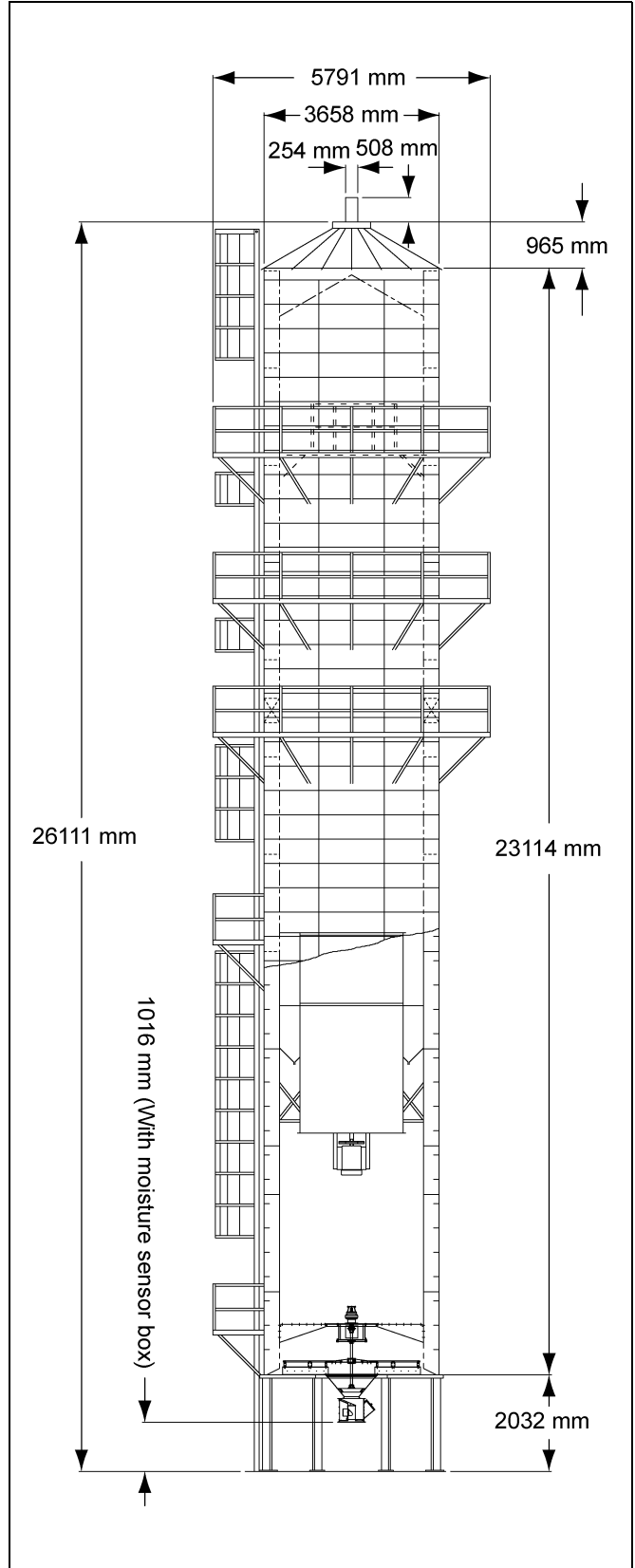

Figure 3F 24100

Dryer Layout

System Layout

When considering dryer location make allowance for:

1. Grain handling systems.
2. Location of storage bins.
3. Wet grain supply.
4. Prevailing wind direction.
5. Fuel and power supply.
6. Noise.
7. Control panel location.

Site Location

Do not locate the dryer:

1. Inside a building.
2. Adjacent to combustible material which sucked in.
3. Within 2.0 m of other structures. Refer to specifications [on Pages 13-15](#) and dimensions [on Pages 16-18](#).

You may need to obtain local permission for the dryer construction and should also consider:

1. Electrical code.
2. Fuel installation regulations.
3. Insurance requirements.

Foundation

Standard foundation details are given in [Figure 4A on Page 20](#) and [Figure 4B on Page 21](#). For ground conditions outside of these standards a local engineer will be required to carry out site specific foundation design.

4. Dryer Installation

Standard Base for Models 1050, 1260, 1575, 1875 and 20100

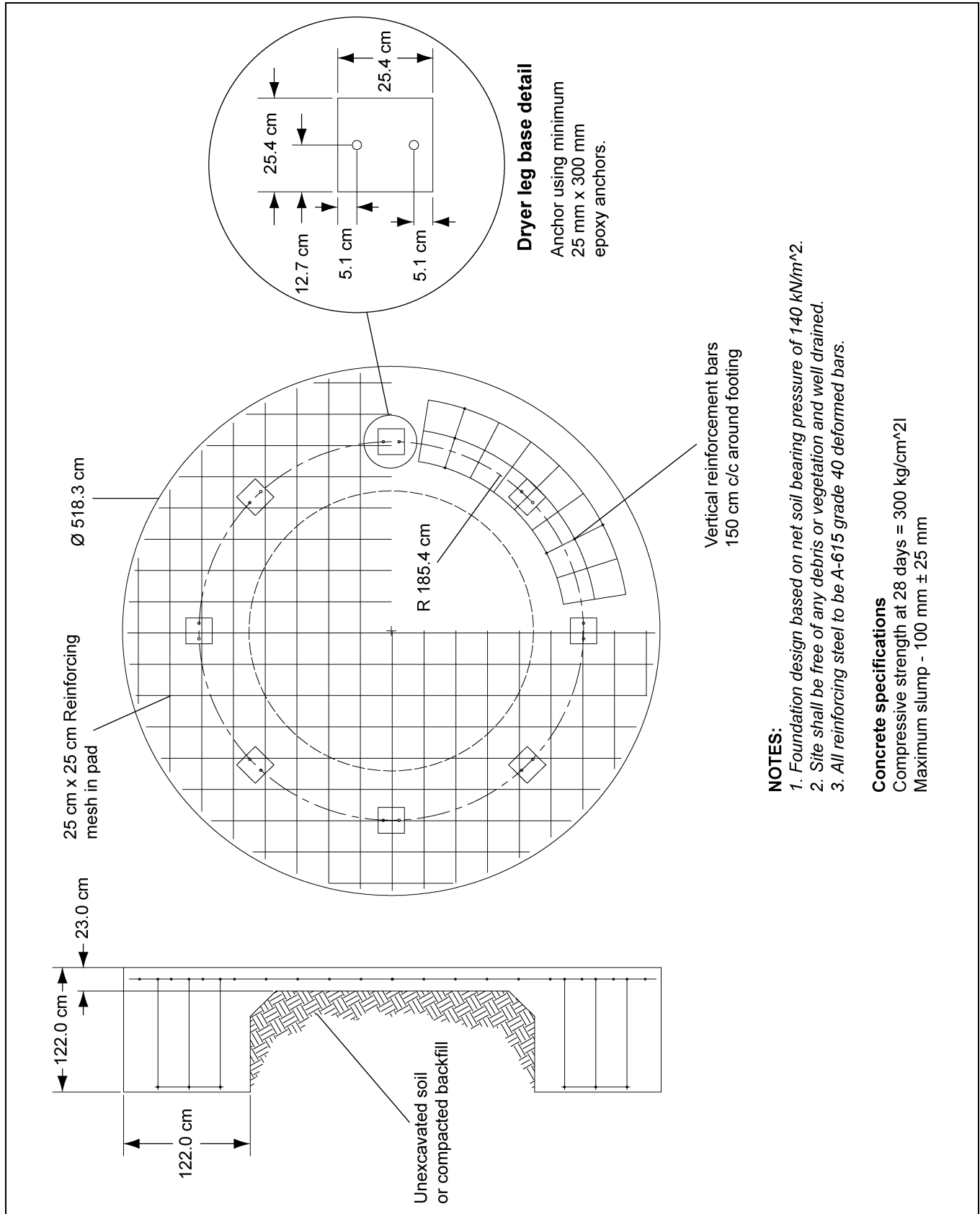

Figure 4A

Standard Base for Model 24100

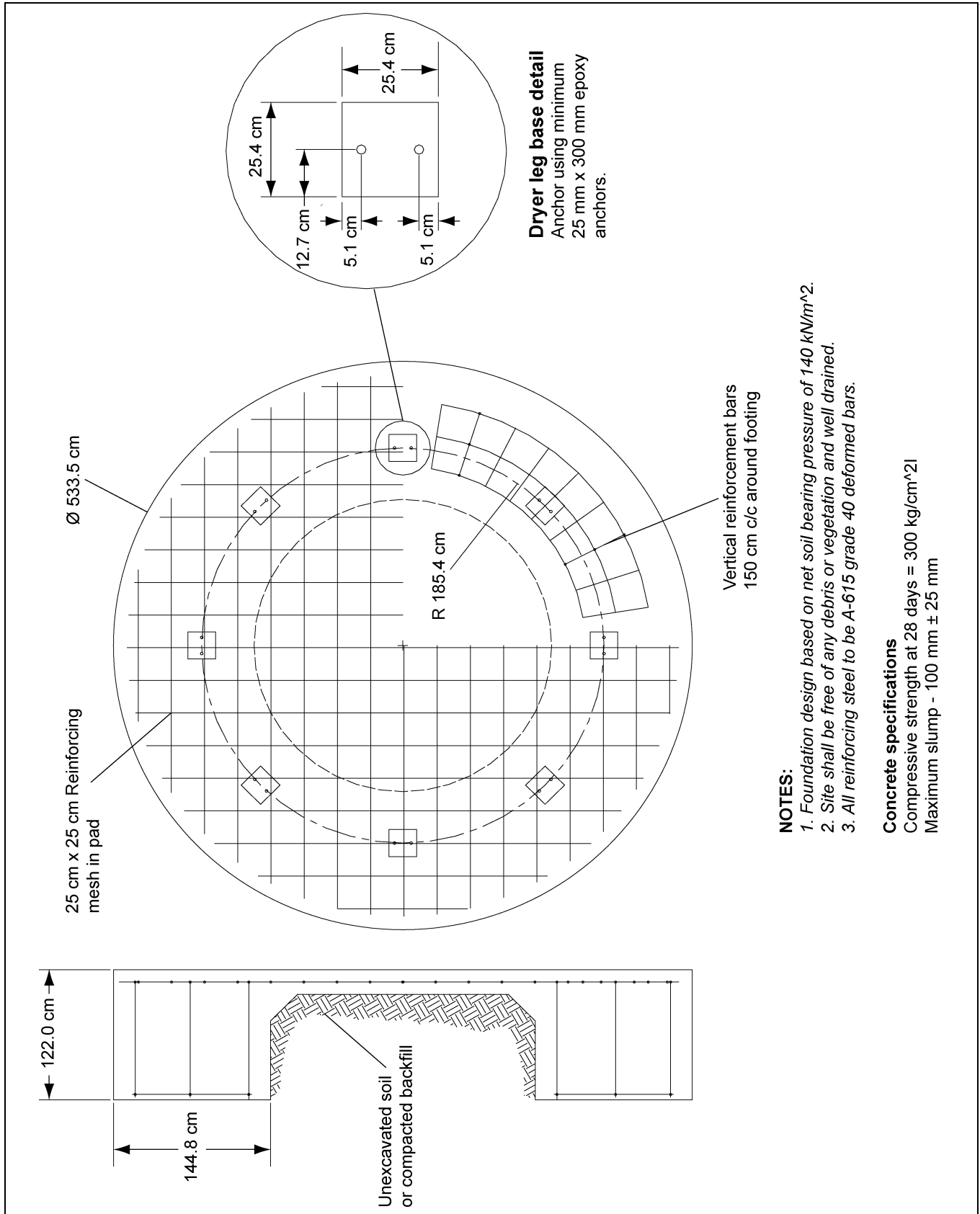

Figure 4B

4. Dryer Installation

Fuel Connections

LPG Dryers with Internal Vaporizers

The dryer is designed to operate on liquid LPG with gross calorific value of 93.8 MJ/m³. The fuel supplier should provide liquid fuel from the tank to intake point at the strainer on the dryer pipe train.

Natural Gas (NG) Dryers

The dryer is designed to operate on natural gas with gross calorific value of 39.0 MJ/m³. The dryer is equipped with a natural gas supply pipe system connected to the heater solenoid valves. A regulated pressure of 700 mBar must be provided at the connection to the dryer, with gas available in sufficient volume to maintain operating pressure.

Commissioning Checks

Before starting the dryer check:

1. Pressure tightness.
2. Over pressure valve operation.
3. Pressure relief operation.
4. Maximum pressure switch operation.

Electrical Connection

1. Power supply must be adequate for the full current draw, plus starting loads for the electrical equipment on the dryer.
2. Power is connected into the main disconnect in the dryer power panel.
3. The dryer must be properly earthed (grounded), which may require the installation of a suitable ground rod. This must be designed and carried out by a suitably qualified electrician in accordance with local regulations and codes and taking into account site ground conditions.
4. Earth connection should be made into the PE terminal in the power panel and to a suitable location on the dryer structure.
5. The electrical installer should carry out full electrical safety checks including earth continuity during commissioning of the dryer.

Connecting Auxiliary Conveyors

Auxiliary load and unload equipment can be wired directly to the dryer.

1. Maximum power not to exceed 7.5 kW.
2. Larger than 7.5 kW must be powered from an alternative source and contactor, though control may be run through the dryer control panel.

Vision Control Panel Layout

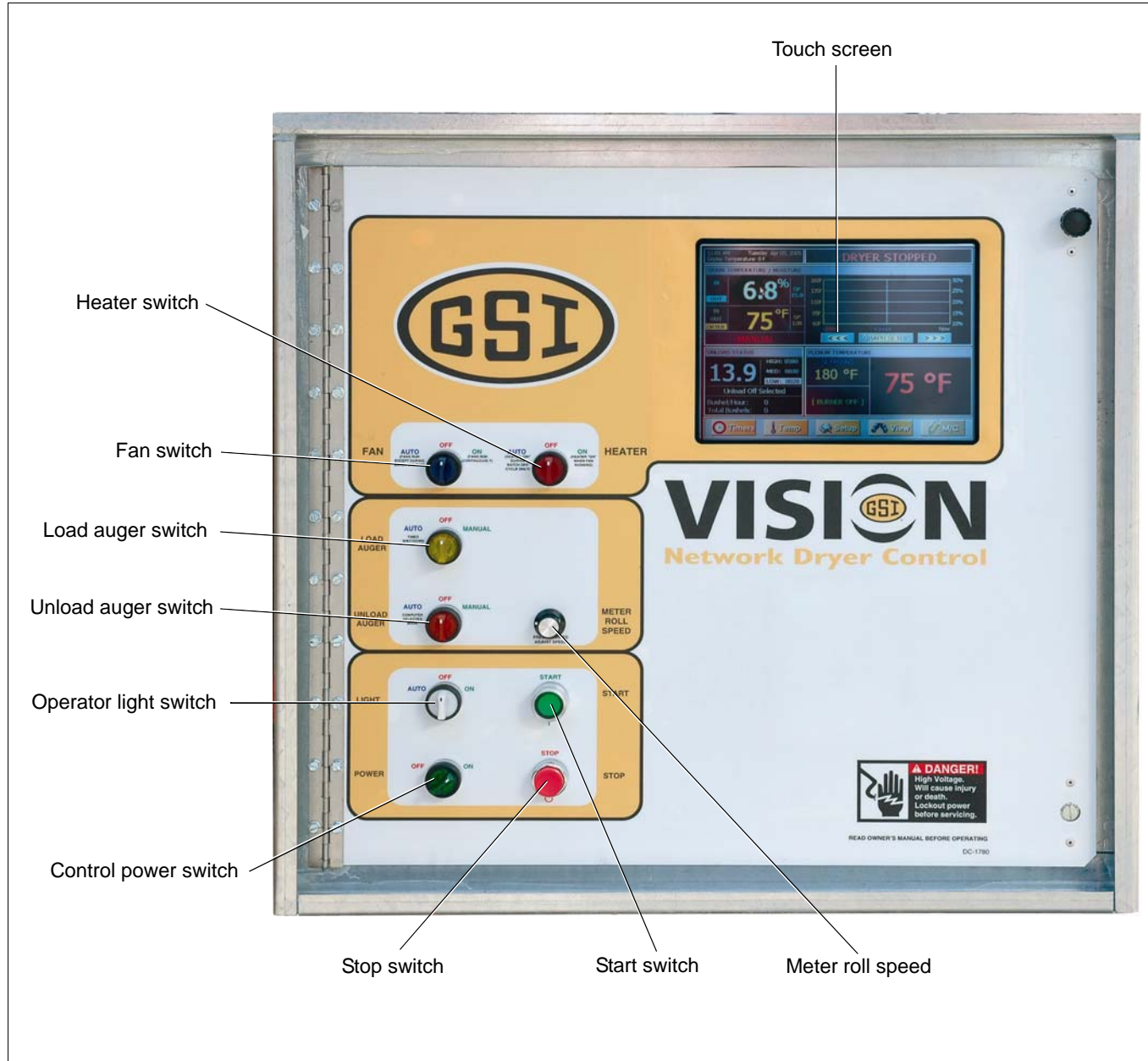

Figure 5A



Switches on the vision panel are for control purposes only. For servicing and maintenance switch OFF and lock at the main disconnect.

Vision controls are used on several GSI drying products. It can operate any dryer in either a batch or a continuous flow mode. All operating instructions for the T-Series dryer describes **continuous flow** operation only.

5. Operating Controls

1. **CONTROL POWER switch** turns ON/OFF power to the control.
2. **FAN switch** starts/stops the fan. AUTO position is not used on T-Series and F-Series dryers.
3. **HEATER switch** turns the heater ON/OFF. AUTO position is not used on T-Series and F-Series dryers.
4. **LOAD AUGER switch** selects operating mode wet fill conveyor. In AUTO and MANUAL, the wet fill conveyor operates to keep the dryer full. In AUTO only the dryer shuts down if it is low on grain for a pre-set period.
5. **UNLOAD switch** controls 'Accutrol' metering system and unload conveyor. In MANUAL, the metering system operates at the speed set by the METERING ROLL SPEED switch. In AUTO, it runs in multi-speed mode, controlled by the automatic moisture control.
6. **OUTSIDE LIGHT switch** controls the service light. In AUTO, the light is ON while the dryer is running and OFF when shut down.
7. **START switch** starts and operates the dryer.
8. **STOP switch** stops all dryer functions except the blower which will continue to run for 15 minutes after the stop has been pressed. To stop the blower before this time, turn the BLOWER switch to OFF.

The STOP switch is also used to re-set after a shut down.

Boot screen appears when the control power is switch ON. (See Figure 6A.)

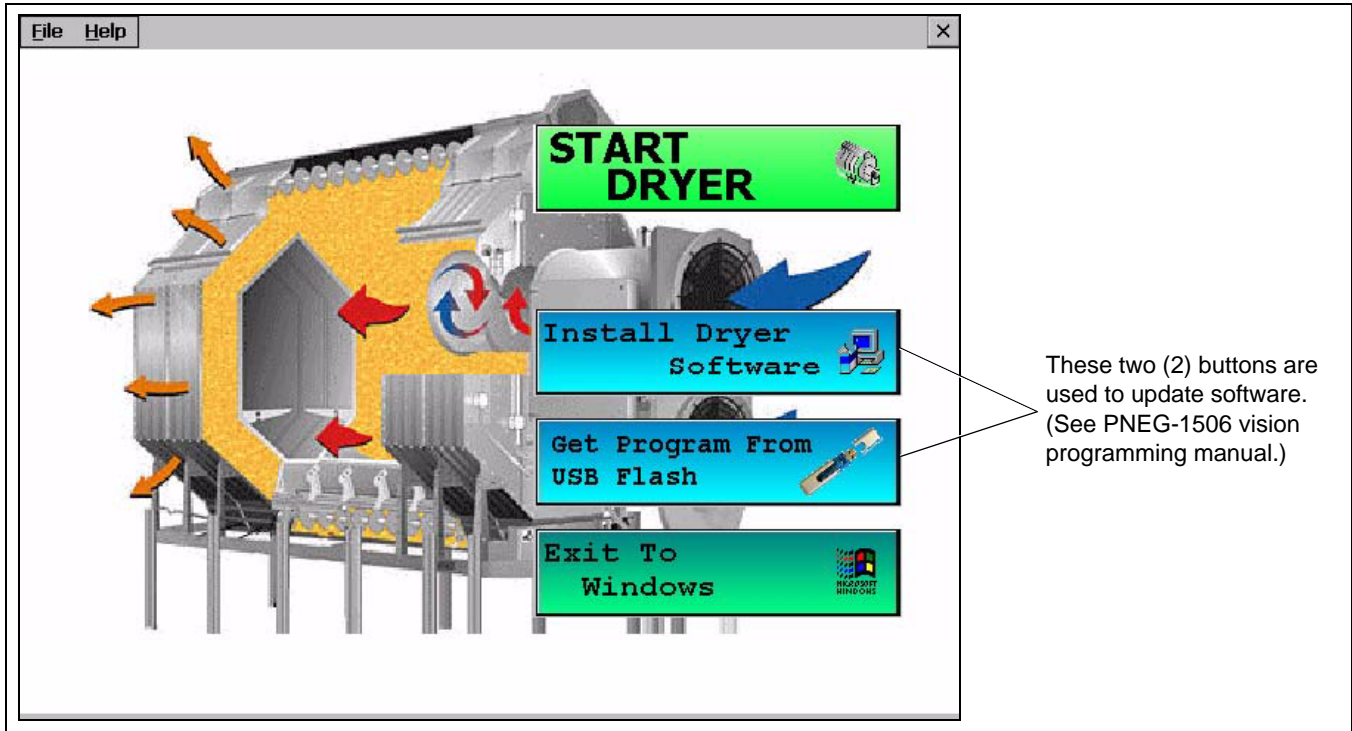

Figure 6A

Default operation screen opens when START DRYER is pressed.

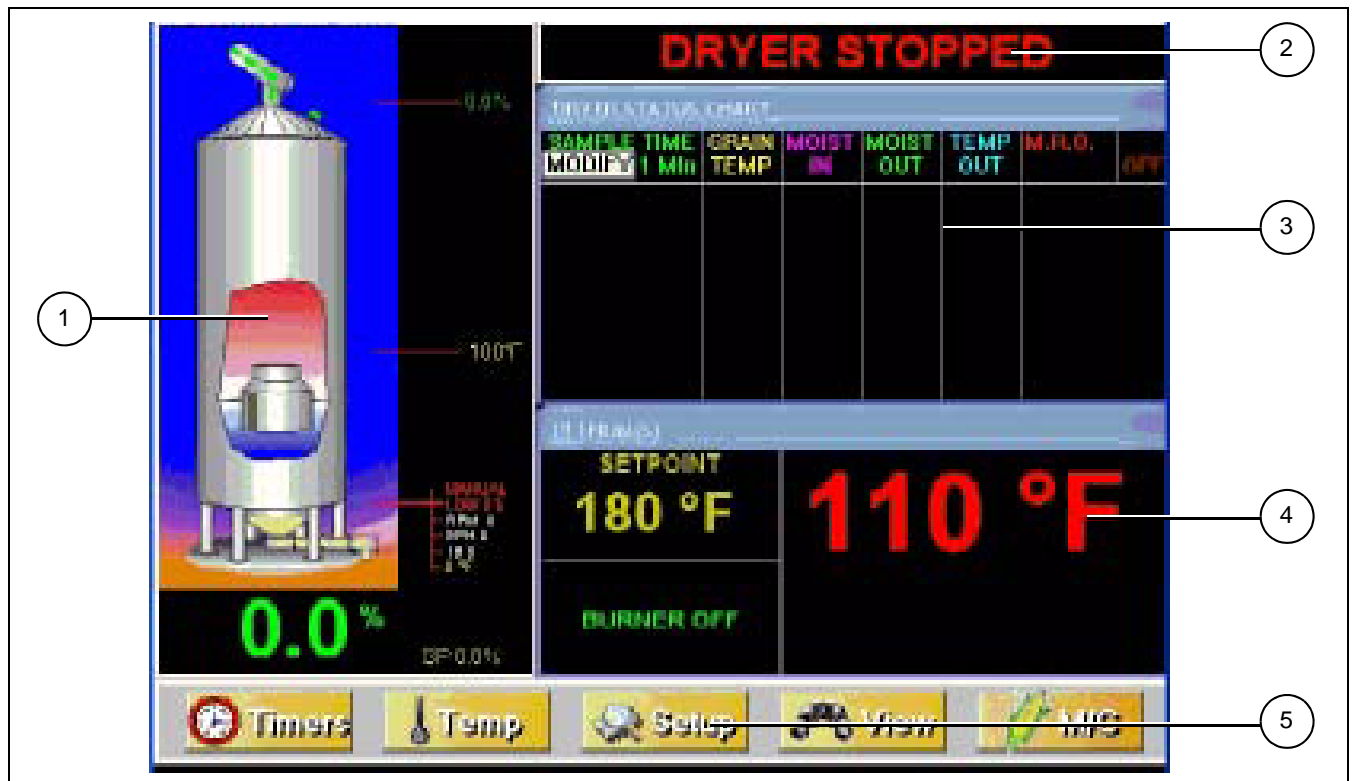

Figure 6B

6. Vision Touch Screen Display

1. **Dryer operation animation** shows the status of the fan/heaters, load and unload augers and meter rolls. Also grain temperature, moisture content, M/C set point and tones counter.
2. **Dryer status** indicates if the dryer is stopped, started, loading or unloading.
3. **Dryer status chart** shows the grain temperature, moisture in/out, temperature out and metering roll speed. Over a period of time.
4. **Plenum** shows the plenum temperature set point (SP), actual plenum temperature and burner status.
5. **Setup buttons** provides access to timers, temperature set points, dryer model and moisture control setup.

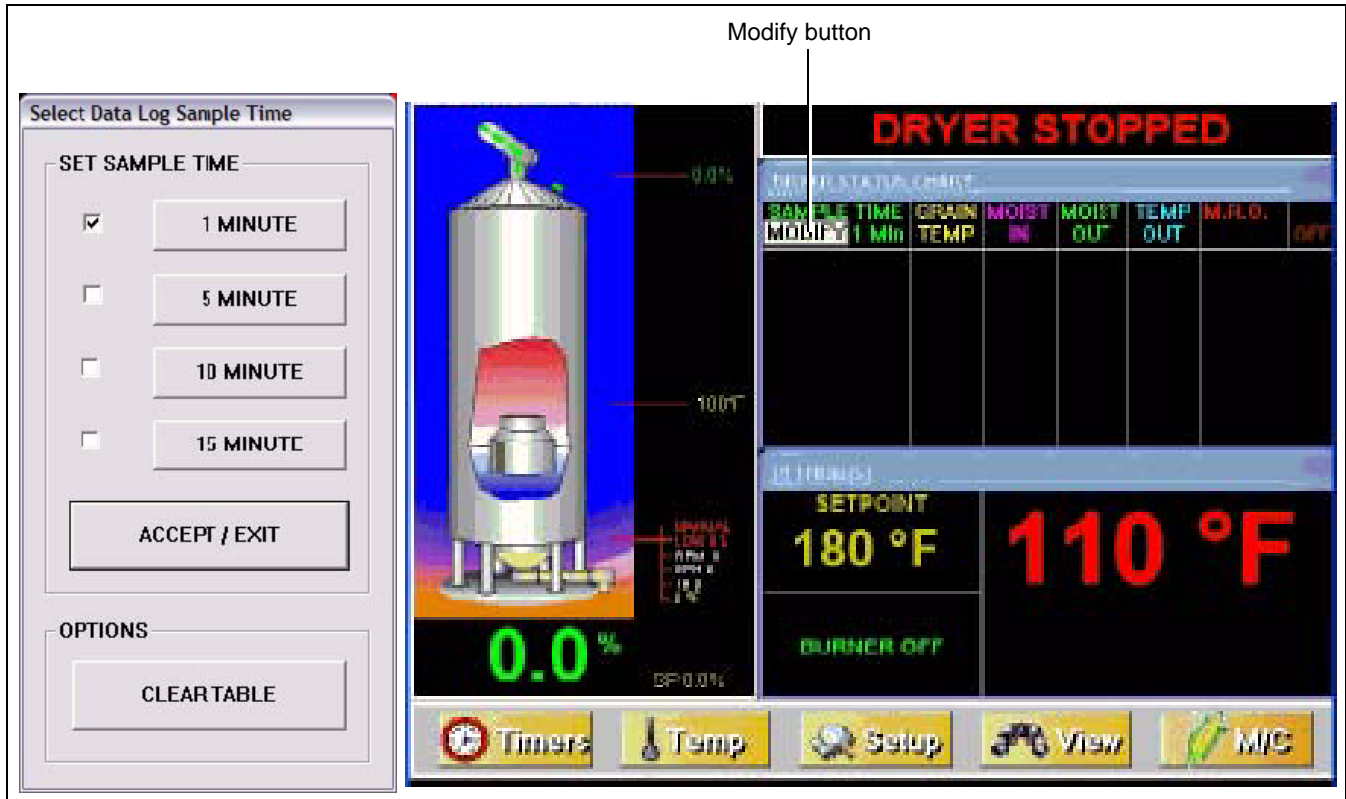

Figure 6C

Select Data Log Sample Time

To change the sample time:

1. Press modify.
2. Select required time.
3. Press Accept/Exit.

To clear the table, press Clear Table button. *(See Figure 6C.)*

Optional Operation Screen



Press View button give four (4) options. (See Figure 6D.)



Figure 6D

1. **Table view:** Default operation screen view. (See Figure 6B on Page 25.)

2. **Graph view:**

a. Press  then .

b. Press any of  to select which data is graphed.

c. Press  to select time period.

3. **Owner's manual:** See Page 33.

4. **History:** See Page 34.

6. Vision Touch Screen Display

Setting the Timers

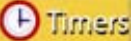
Press  to open the timers screen. (See Figure 6E.)

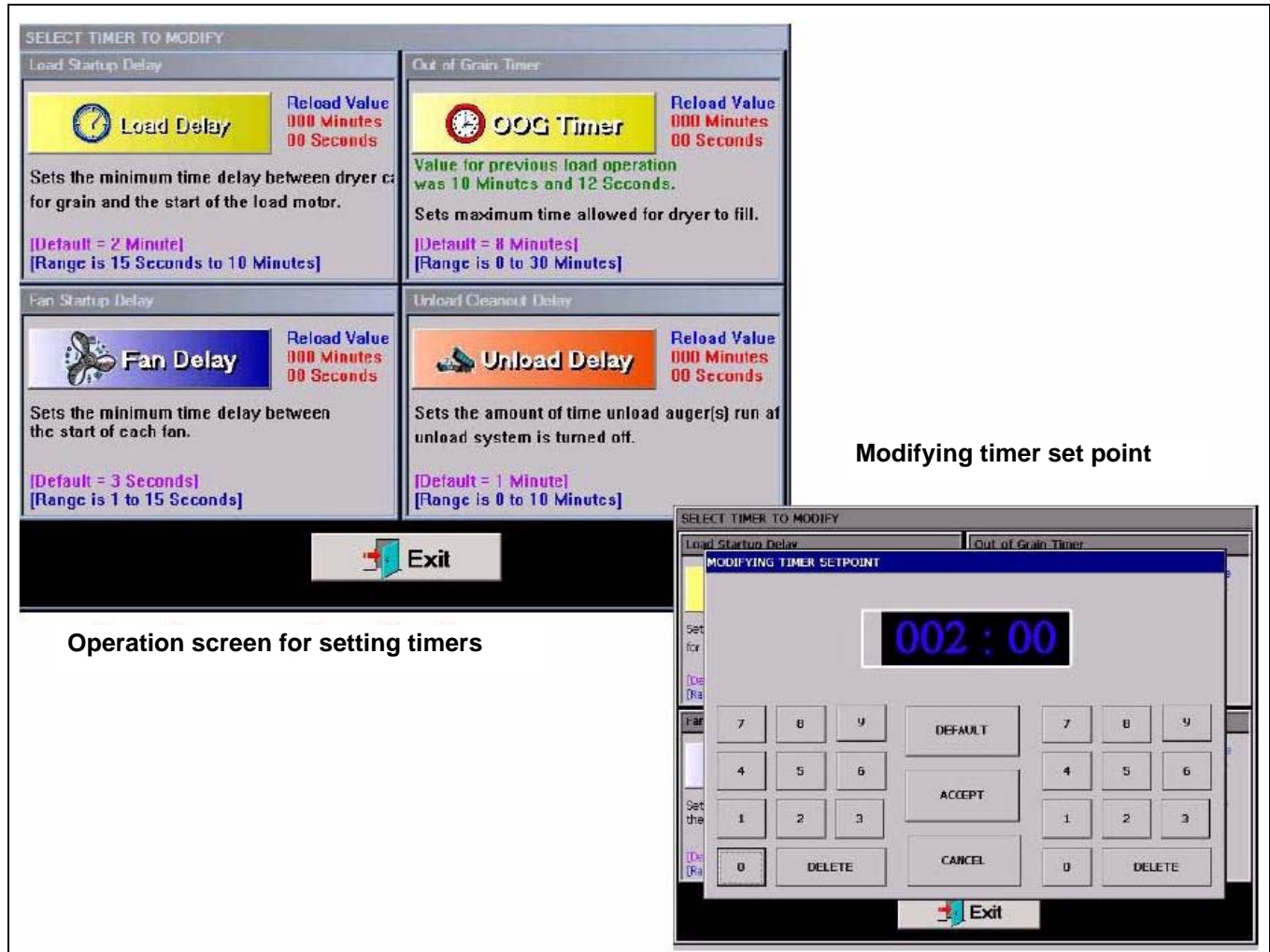





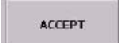



Figure 6E

1. Press  to set the load system delay during unload. Reduces load motor cycling.
2. Press  to set the dryer shut down delay after the OUT OF GRAIN switch opens. Set to the maximum time for the dryer to refill during drying (this is displayed during loading on the screen).
3. Press  to set the time between sequential fan starts (multiple fan dryers only).
4. Press  to set the unload system overrun following metering system shut down (allows unload system to clear itself).

5. Use  when setting timers. Note default values may be entered.



6. Press  then  to return to the operation screen. (See Figure 6B on Page 25.)

Setting the Temperatures

1. Press  to display temperature setup screen. (See Figure 6F.)

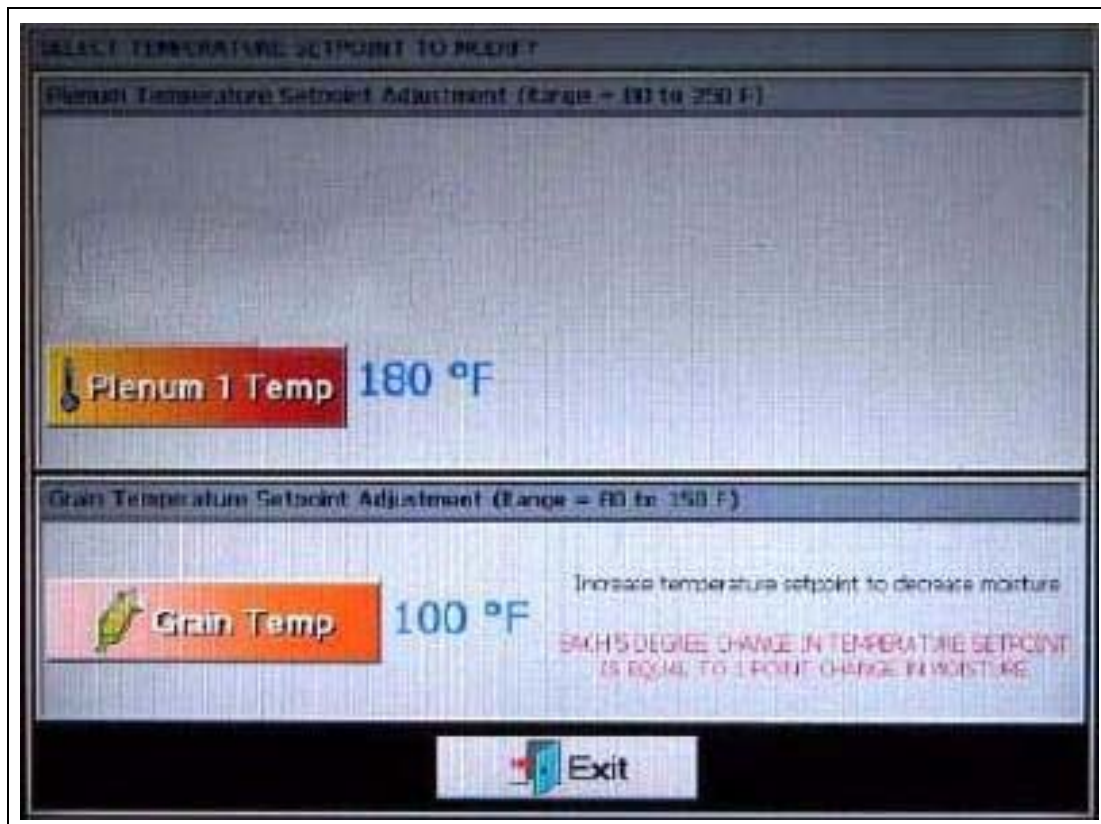
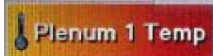

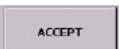



Figure 6F

2. Press  then use key pad to alter plenum temperature.
3. Press  then use key pad to alter grain temperature.

Note default units are °F. This can be changed to °C in SETUP.

4. Press  then  to return to the operation screen. (See Figure 6B on Page 25.)

6. Vision Touch Screen Display

The Setup Screen

Press  **Setup** adjust other dryer settings.

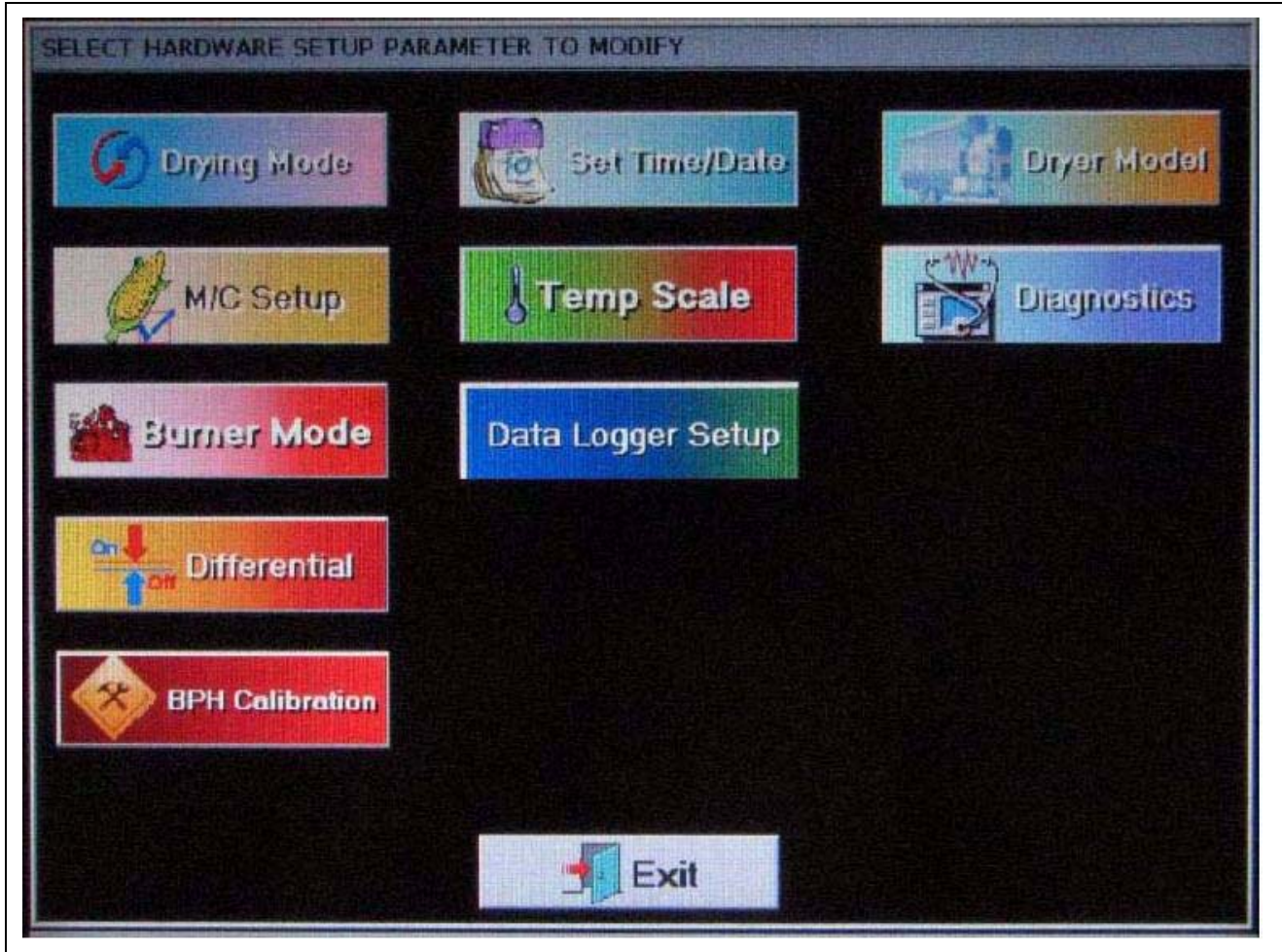
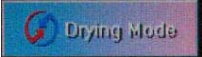
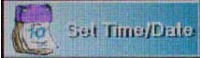
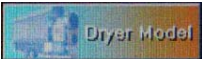
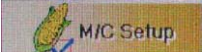

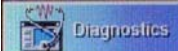
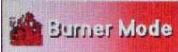

Figure 6G

-  select continuous flow or staged batch drying modes.
-  adjust time and date settings.
-  select correct dryer model an details, as follow:
 - Number fan/heaters = 1
 - Load system = end
 - Dryer length (ft.) = 22 (Models 1875, 20100 and 24100)
18 (Models 1050, 1260 and 1575)
 - Number modules = 1
 - Fuel = LP
-  [See Page 48](#) for detailed setup.

5.  changes between SI and American units.
6.  see service section on [Page 56](#).
7.  burner mode should be ALL HIGH/LOW. (*See Figure 6H.*)

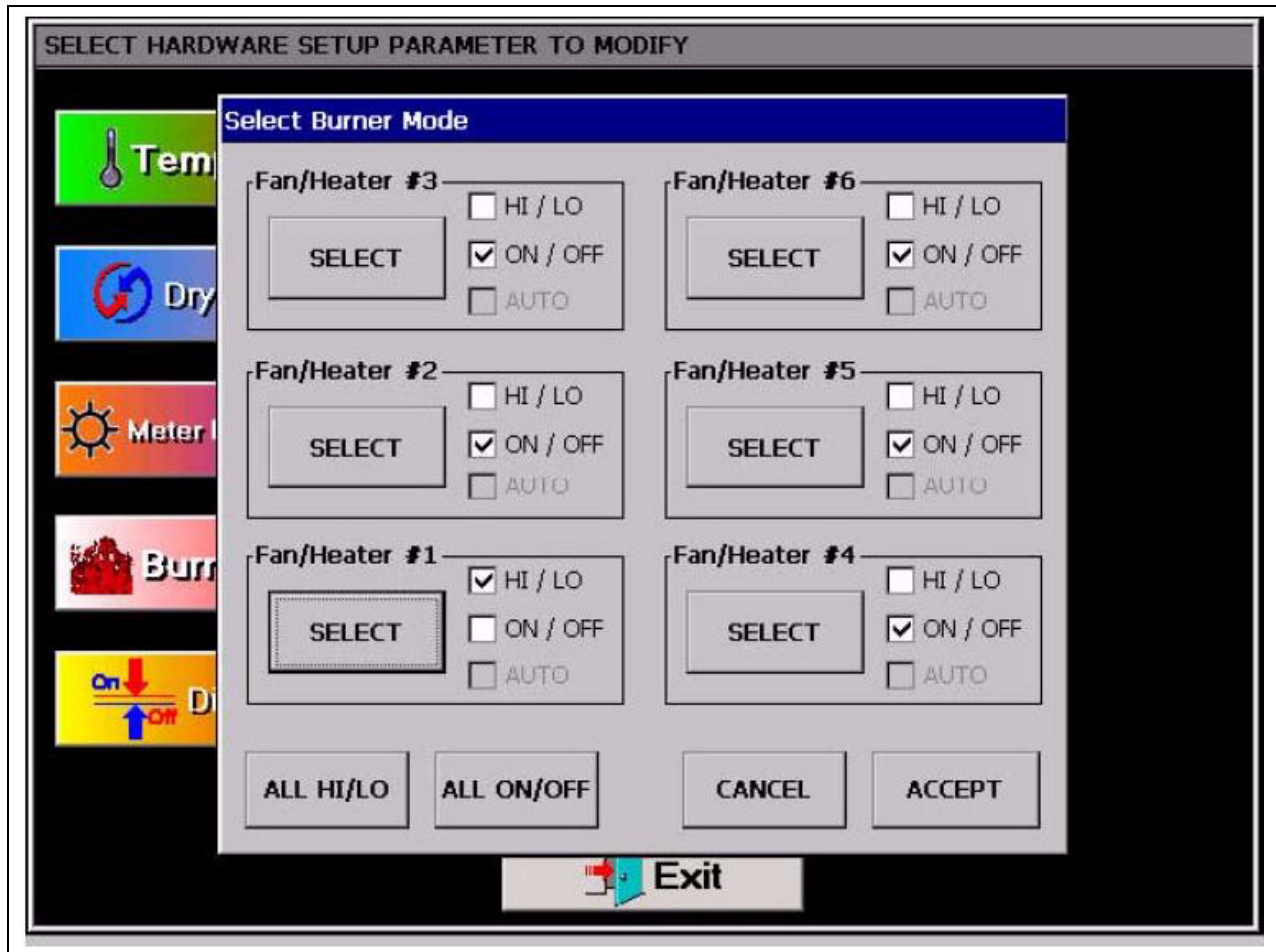
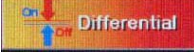

Figure 6H

8.  to adjust the switching range of the burner. (*See Figure 6I on Page 32.*) Default is 3°F (1°C). Tower dryers have just 1 plenum.

6. Vision Touch Screen Display

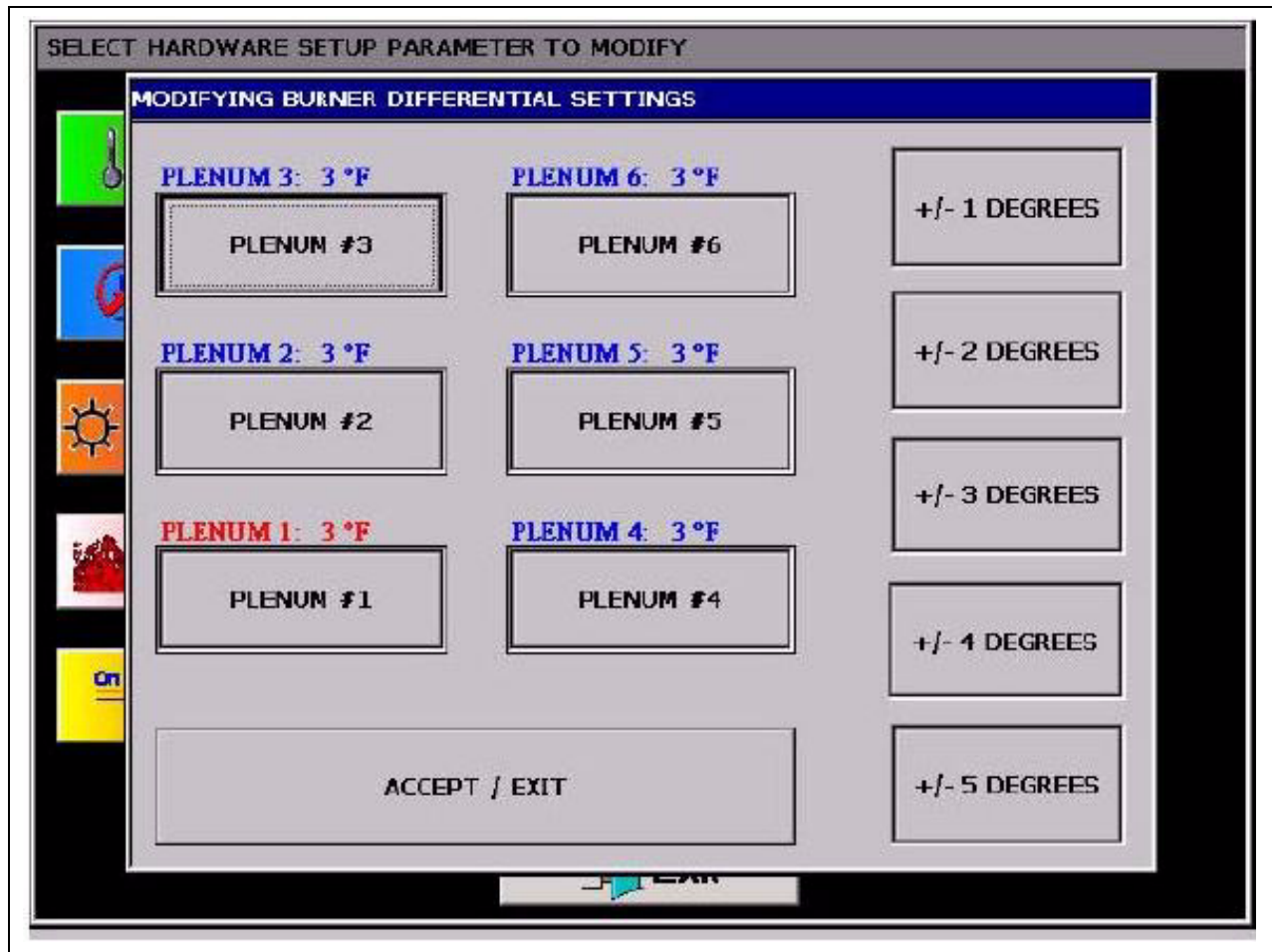



Figure 6I

9.  allows the dryer throughput meter to be calibrated on [Figure 6J](#).
Setting = (Actual tons per hour/Recorded tons per hour)*100

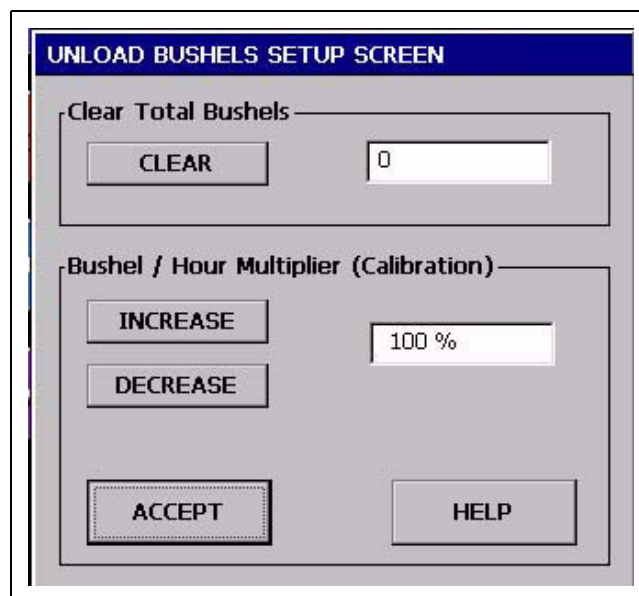



Figure 6J

Viewing the Owner's Manuals on the Display Screen

Press  then the Owner's Manual button. (See Figure 6K.)

At the explorer screen, double press the manual and wait for it to open on screen.

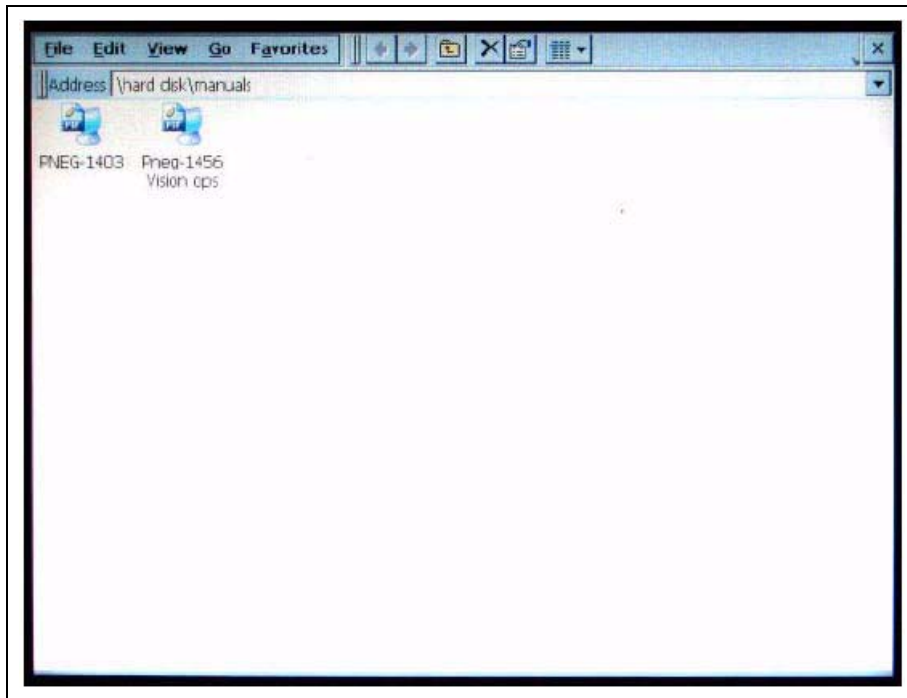

Figure 6K

Use the scroll bar to navigate the manual. (See Figure 6L.)

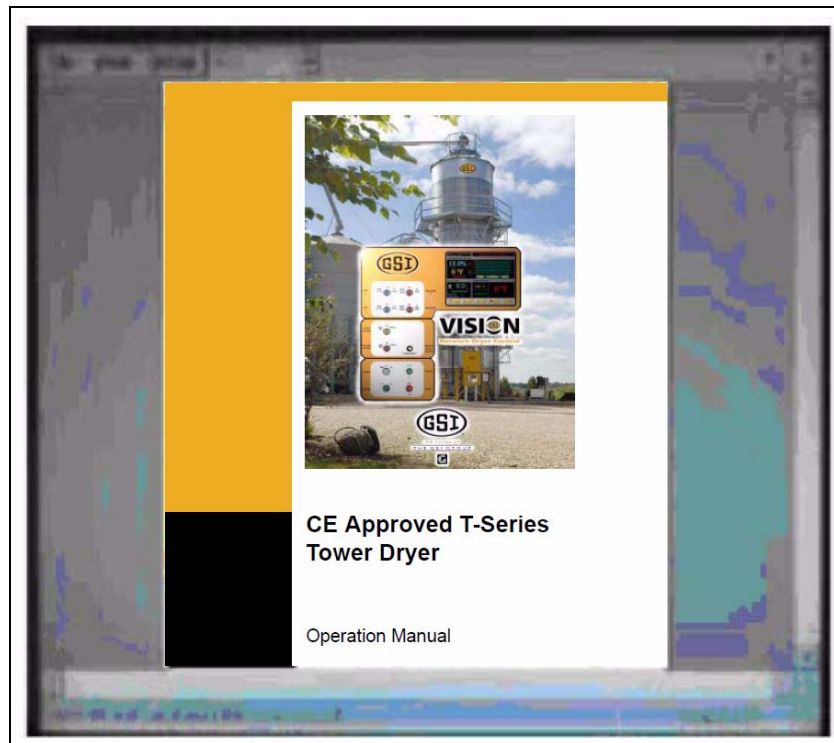



Figure 6L

Viewing the Dryer Shut Down History

Press  **View** and then history. (See Figure 6M.)

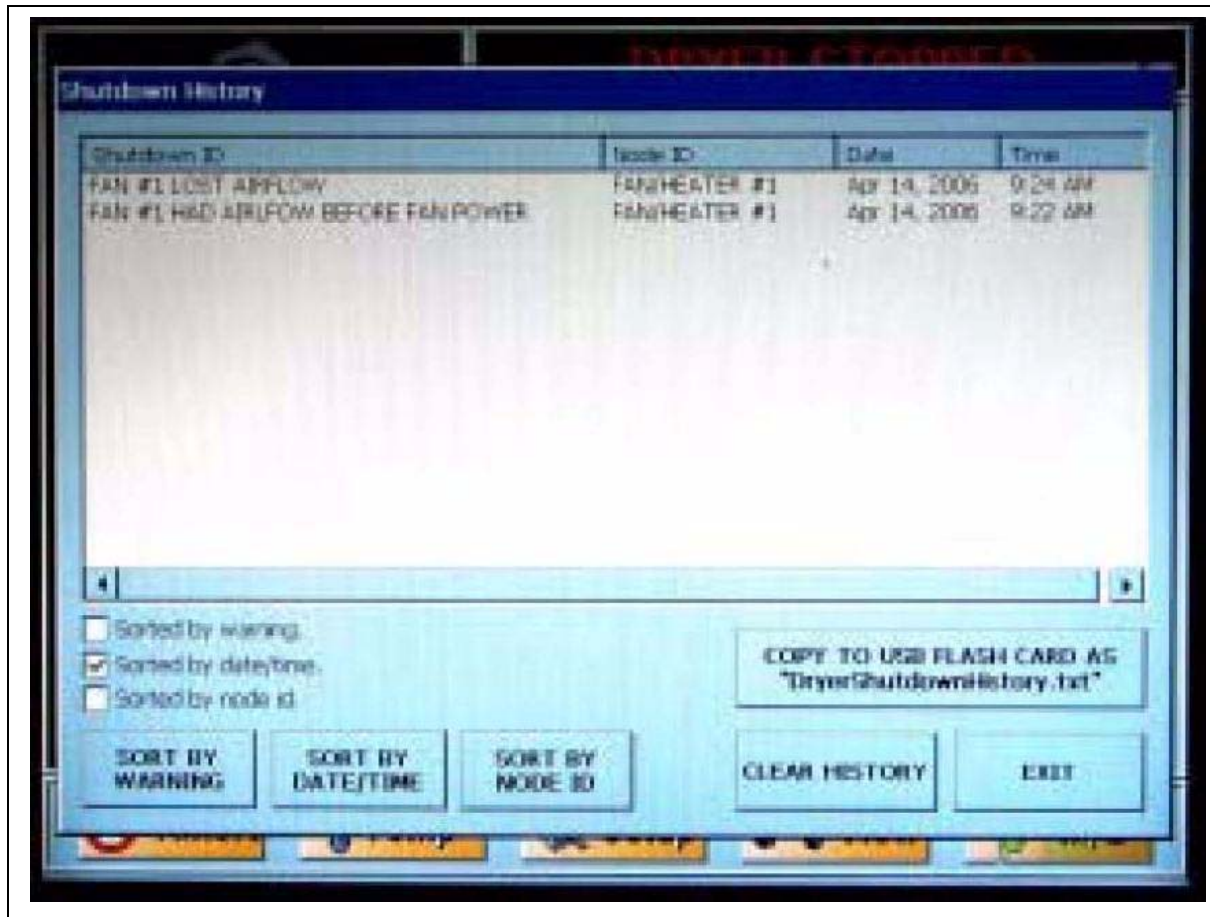

Figure 6M

The shut down history is displayed and can be copied to a flash disc for viewing on another computer.



BEFORE STARTING THE DRYER. All safety guards must be in place. All personnel must stay away from the dryer. All access doors must be closed.

Dryer Commissioning

Electrical

1. Carry out earth bonding test per EN60204 and/or local electrical laws and regulations.
2. Check adequate power supply. (Refer to table [on Page 15.](#))
3. Voltage at phases must be within 5% of rated voltage.
4. Voltage drop must not exceed 5% when under full load.
5. Check overload settings for each motor circuit.
6. Complete full electrical tests in accordance with EU directives and local laws, regulations and codes.

Gas Train

1. Pressure test
 - a. Close inlet valve. ([See Figure 7C on Page 41.](#))
 - b. Close firing valve. ([See Figure 7G on Page 43.](#))
 - c. Close pilot line valve. ([See Figure 7E on Page 42.](#))
 - d. Fit pressure test nipple into main solenoid inlet flange.
 - e. Attach hand bellows and pressure gauge.
 - f. Pressurise gas train with air to 35 kPa (350 mBar).
 - g. Check for pressure loss at gauge.
 - h. Use leak detection to test for leaks.
 - i. Repeat on outlet flange.
 - j. Repeat on pilot line.
2. Set inlet pressure per table [on Page 15.](#)
3. Set relief valve per table [on Page 15.](#)
 - a. Apply air pressure via main solenoid inlet flange.
 - b. Increase/decrease spring pressure in relief valve.
 - c. Valve should open at 50 kPa maximum.

7. Dryer Start-Up

4. Set over pressure shut off (OPSO) per table [on Page 13](#).
 - a. Apply air pressure via main solenoid inlet flange.
 - b. Increase/decrease spring pressure in OPSO.
 - c. Valve should shut open at 45 kPa maximum.
5. Set operational pressure per table [on Page 15](#).
 - a. Open main gas valve.
 - b. Adjust pressure at regulator.
6. Set pilot flow rate (must be done with pilot alight).
 - a. Open pilot valve. ([See Figure 7E on Page 42.](#))
 - b. Disconnect solenoid connection on main valves.
 - c. Start blowers.
 - d. Start burners.
 - e. When pilot solenoid valve opens, adjust flow rate to give required pilot pressure per table [on Page 15](#).
 - f. Adjustment is on pilot solenoid valve.

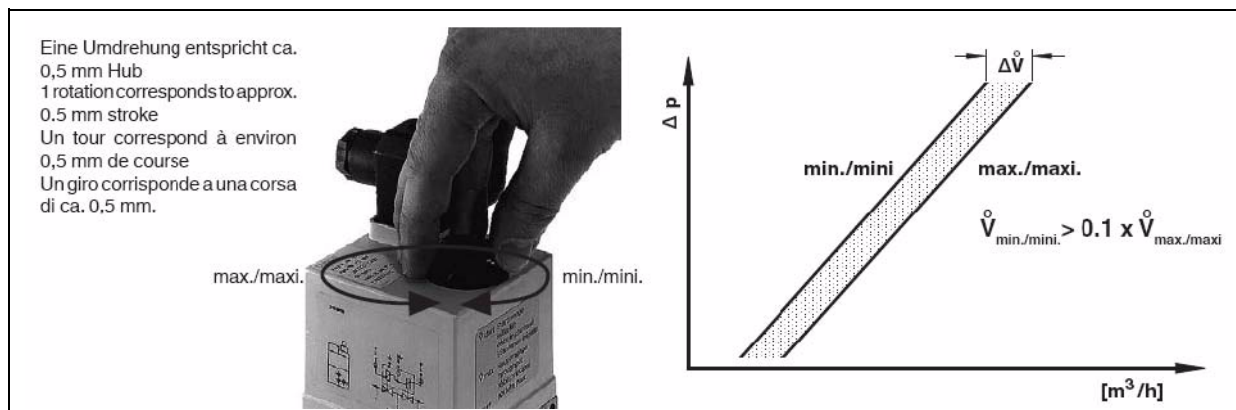



Figure 7A Pilot Valve Flow Adjustment

7. Set burner high-fire pressure.
 - a. Re-connect main solenoid valves.
 - b. Note required high-fire pressure from table [on Page 15](#).
 - c. Set plenum temperature to approximately 200°F above ambient.
 - d. Light burners.
 - e. Check modulating valve has driven fully open.
 - f. Read pressure at burner gauge. ([See Figure 7D on Page 41.](#))
 - g. Adjust pressure a regulator to give required pressure.
 - h. Lock regulator.

8. Set burner low-fire pressure.
 - a. Set plenum temperature to approximately 10°F above ambient.
 - b. Light burners.
 - c. On low-fire, adjust modulating valve minimum setting to give pressure as per table [on Page 13](#).
9. Read pressure at burner gauge. ([See Figure 7D on Page 41.](#))
10. Run burners and check burner modulates correctly.
11. Check gas pressure remains stable.
12. Fill out gas train commissioning check sheet.

Pre-Season Checks

1. Inspect the accutrol metering system.
 - a. Open the two (2) access doors and inspect the sweep metering system to ensure that the system is able to move freely.
2. Gas train
 - a. Check for any leaks by pressurizing the line with air and using gas leak disclosing solution or by doing pressure loss tests.
 - b. Leaks must be rectified by opening and resealing the joint.
3. Wiring
 - a. Check wiring on the dryer and inside the control panels for signs of damage or loose connections. Rectify any faults.
4. Electrical power
 - a. Check all circuit breakers in the panel are closed.
 - b. Turn ON the electrical power supply to the dryer.
 - c. Check for correct voltage on all phases.
5. CONTROL POWER switch
 - a. Turn the CONTROL POWER switch to ON.
 - b. At boot screen appears ([See Figure 6A on Page 25](#)), press  .
 - c. Any faults will be displayed on the Main screen.
 - d. If no faults are found safe, the START switch will illuminate.

7. Dryer Start-Up

6. START switch
 - a. Check all selector switches are OFF.
 - b. Push the DRYER START switch.
 - c. Selector switches be activated.
7. Fuel check
 - a. Open the gas supply to the dryer.
 - b. Check correct supply pressure. *(See Table on Page 15.)*
8. Load auger. With grain supply OFF.
 - a. Start and stop load auger to check correct operation and rotation.
 - b. Turn the load auger to AUTO and allow to run for 8 minutes.
 - c. Dryer should stop and display OUT OF GRAIN error message.
 - d. Press STOP to clear message.
9. Unload operation
 - a. Turn unload auger to AUTO. Check correct operation and rotation.
 - b. Turn unload auger to MANUAL position. Check correct operation and rotation.
10. Accutrol sweep metering system operation
 - a. With unload in AUTO, check metering speed increases and decreases as control is adjusted.
 - b. Turn unload OFF. Unload will continue for 60 seconds and shut down.
11. FAN switch
 - a. Turn FAN switch to ON the OFF and check correct operation and rotation.
12. Burner safety
 - a. Turn fuel OFF.
 - b. Start the fan.
 - c. Turn HEATER switch to ON.
 - d. Burner should attempt to light and then lockout.
 - e. Display should read "Ignition Failure Fan 1".

13. Burner test fire

- a. Turn fuel ON.
- b. Set plenum temperature to 60°C.
- c. Start the fan.
- d. Turn HEATER switch to ON.
- e. After purge the burner should light.
- f. Adjust the pressure regulator to required burner pressure. *(See Table on Page 15.)*
- g. Lock the regulator.
- h. When the plenum reaches set point, adjust the MINIMUM setting on the modulating valve *(See Figure 7G on Page 43)* to the required setting. *(See Table on Page 15.)*
- i. Allow the burner to cycle between high and low and stabilize at the set point.
- j. Fine adjustment may be needed to obtain good temperature modulation.

14. Dryer shut down

- a. Short term shut down.
 - Turn burner OFF.
 - Turn fan OFF.
 - Turn load OFF.
 - Turn unload OFF.
 - Close main fuel valve.
- b. Long term shut down.
 - Close the fuel supply and allow the burner to burn out.
 - Turn all selector switches to OFF.
 - Turn control power OFF.
 - Disconnect main power.

15. Emergency PRESS EMERGENCY STOP.

7. Dryer Start-Up

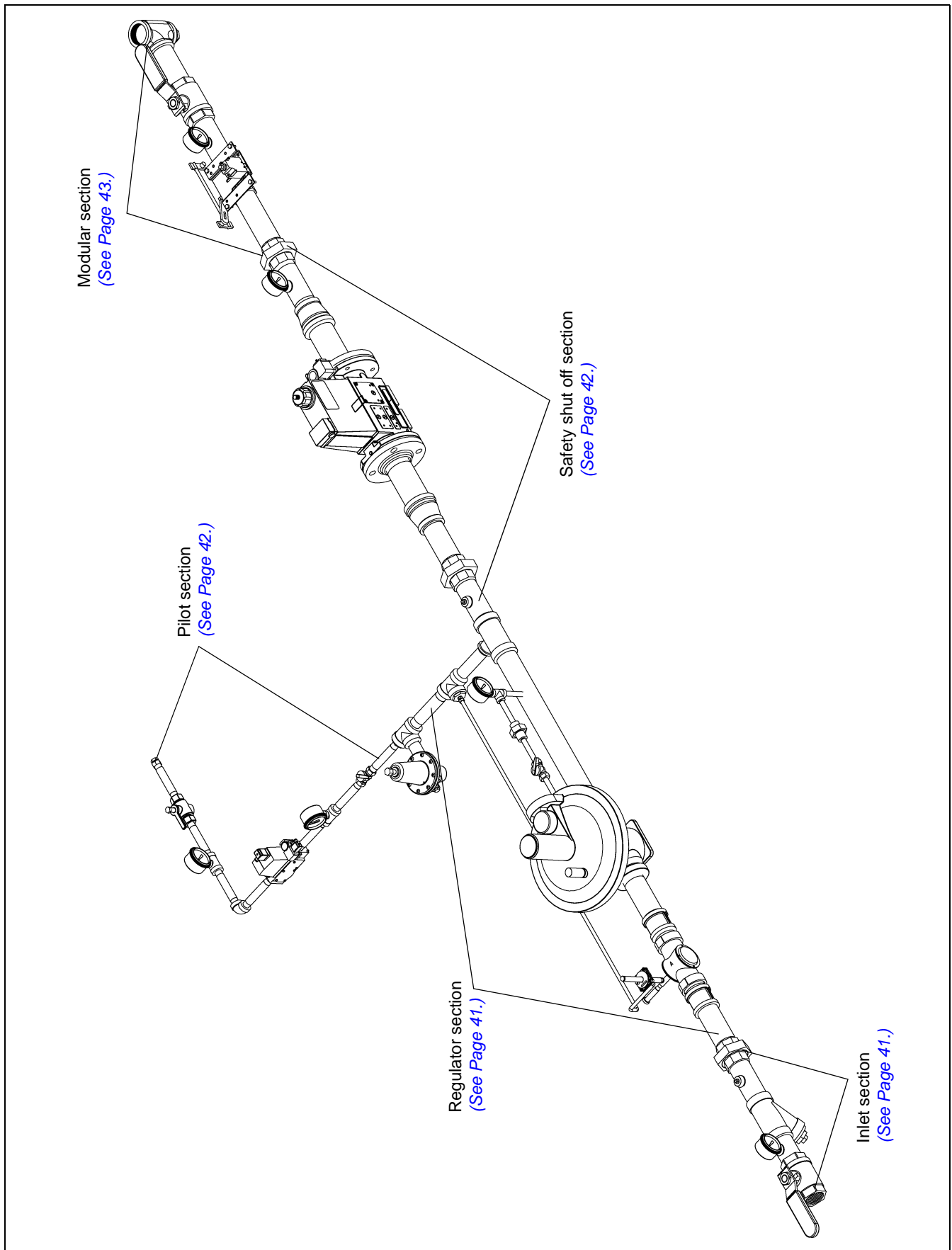

Figure 7B Tower Dryer CE Pipe Train (2" Shown)

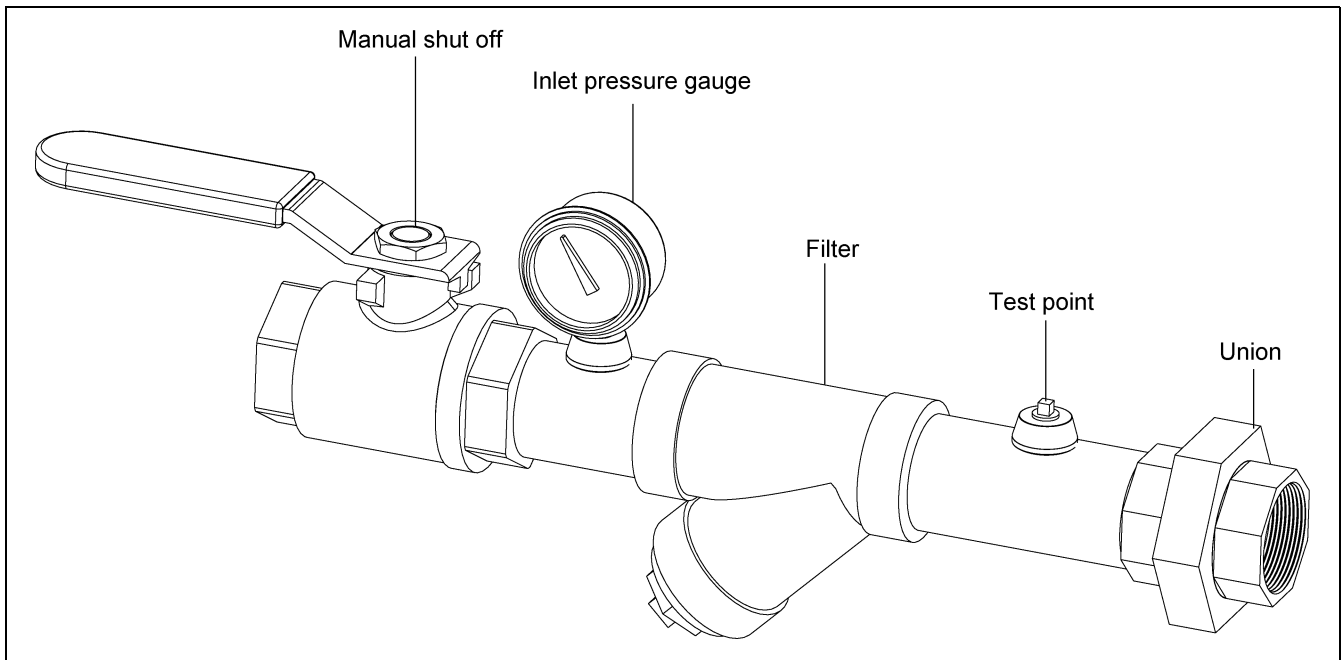

Figure 7C Inlet Section

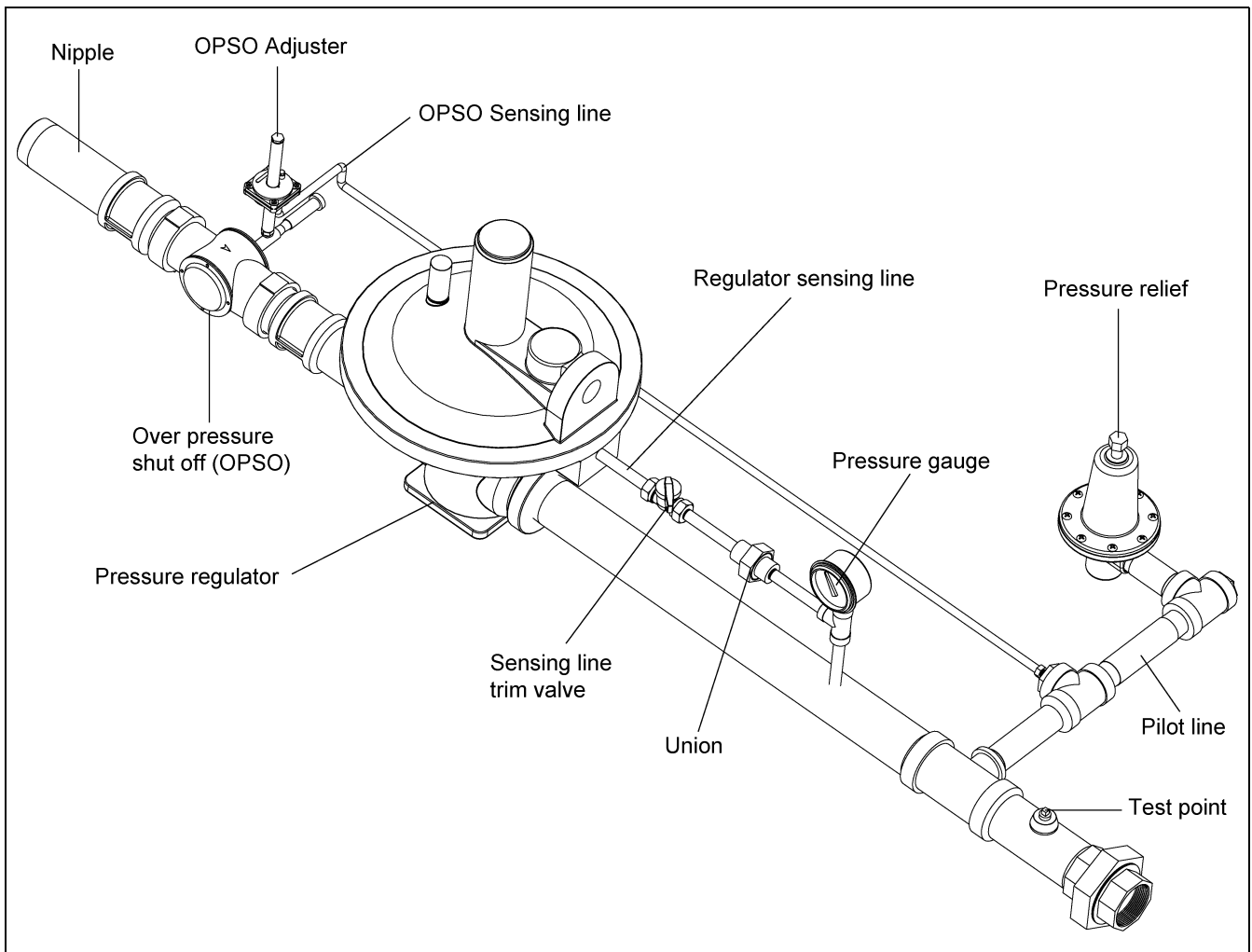

Figure 7D Regulator Section

7. Dryer Start-Up

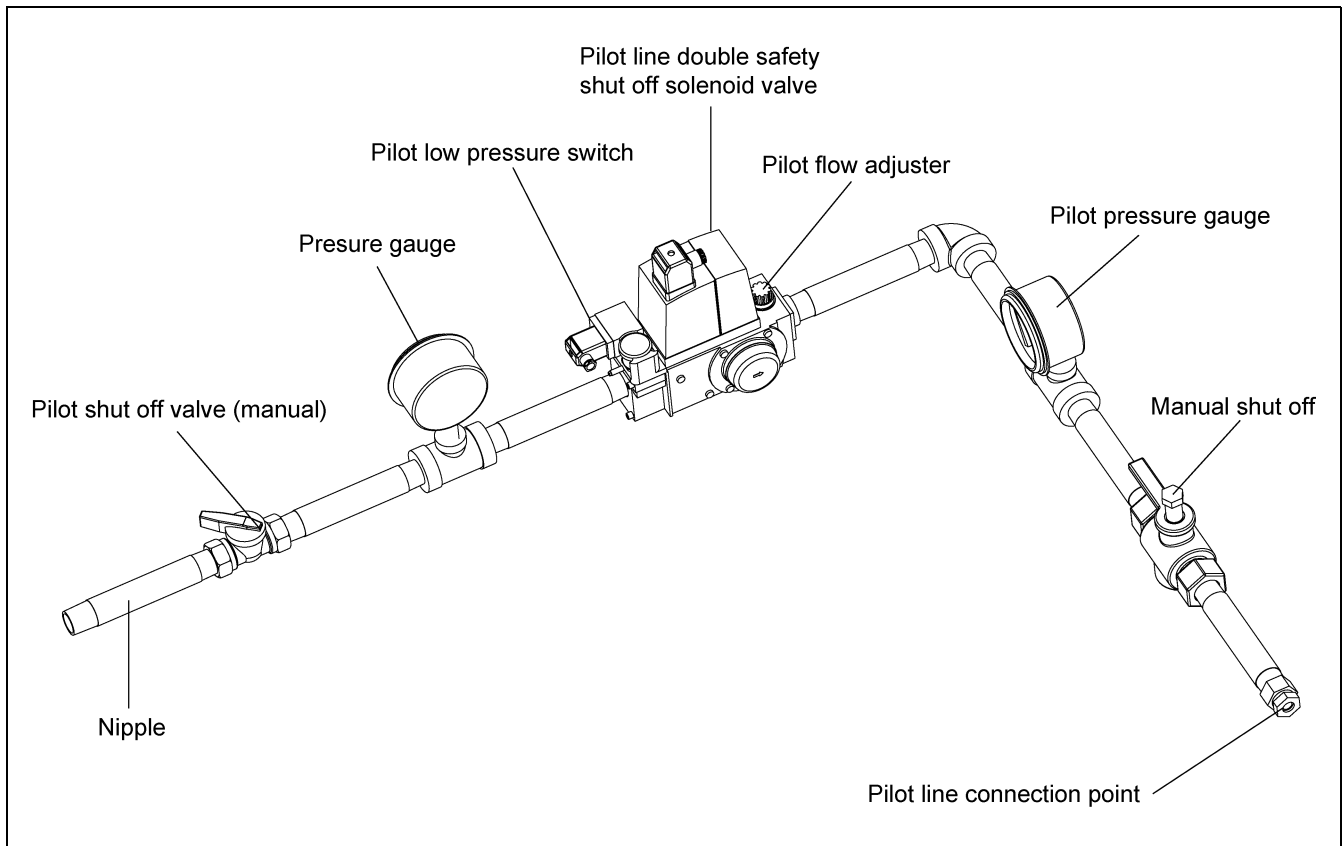

Figure 7E Pilot Section

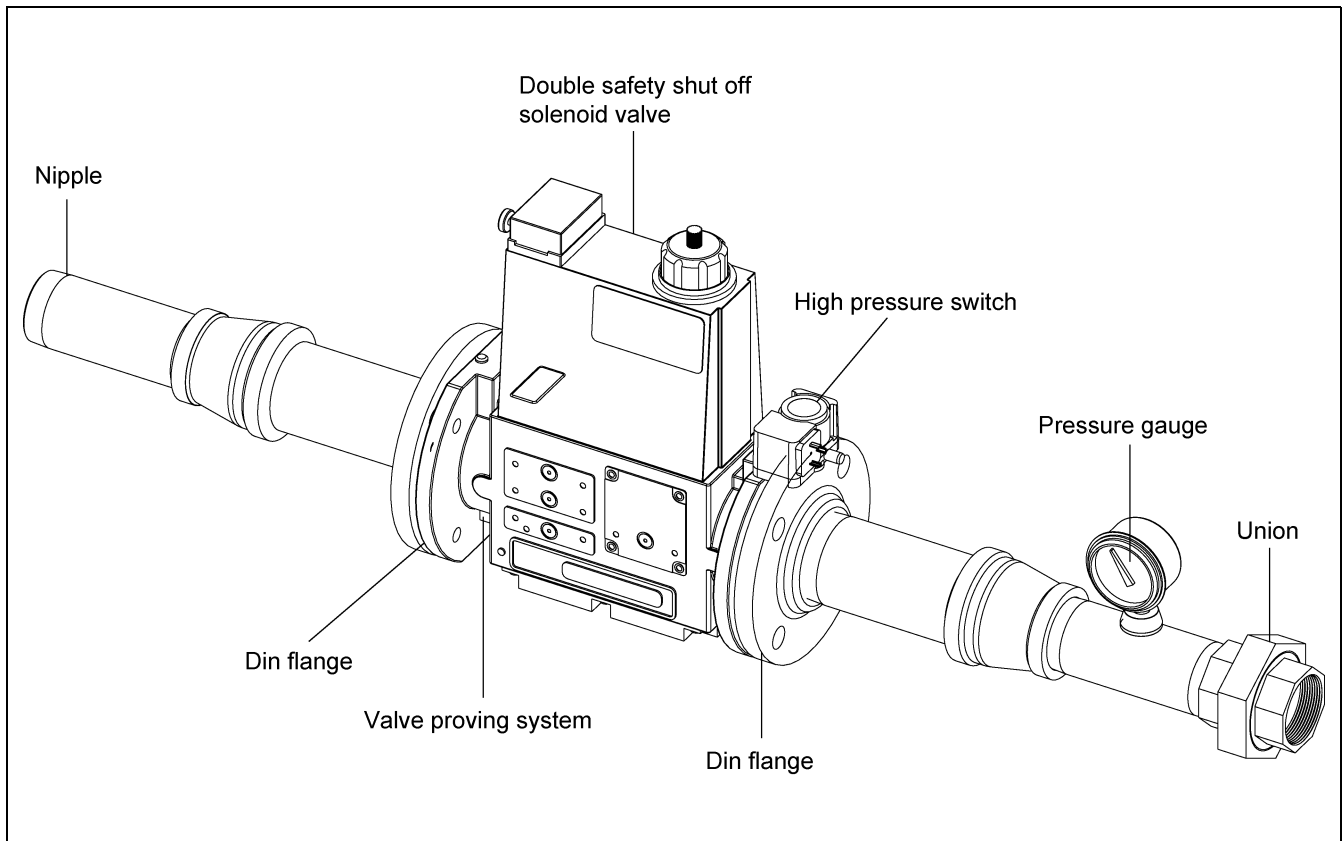

Figure 7F Safety Shut Off Section

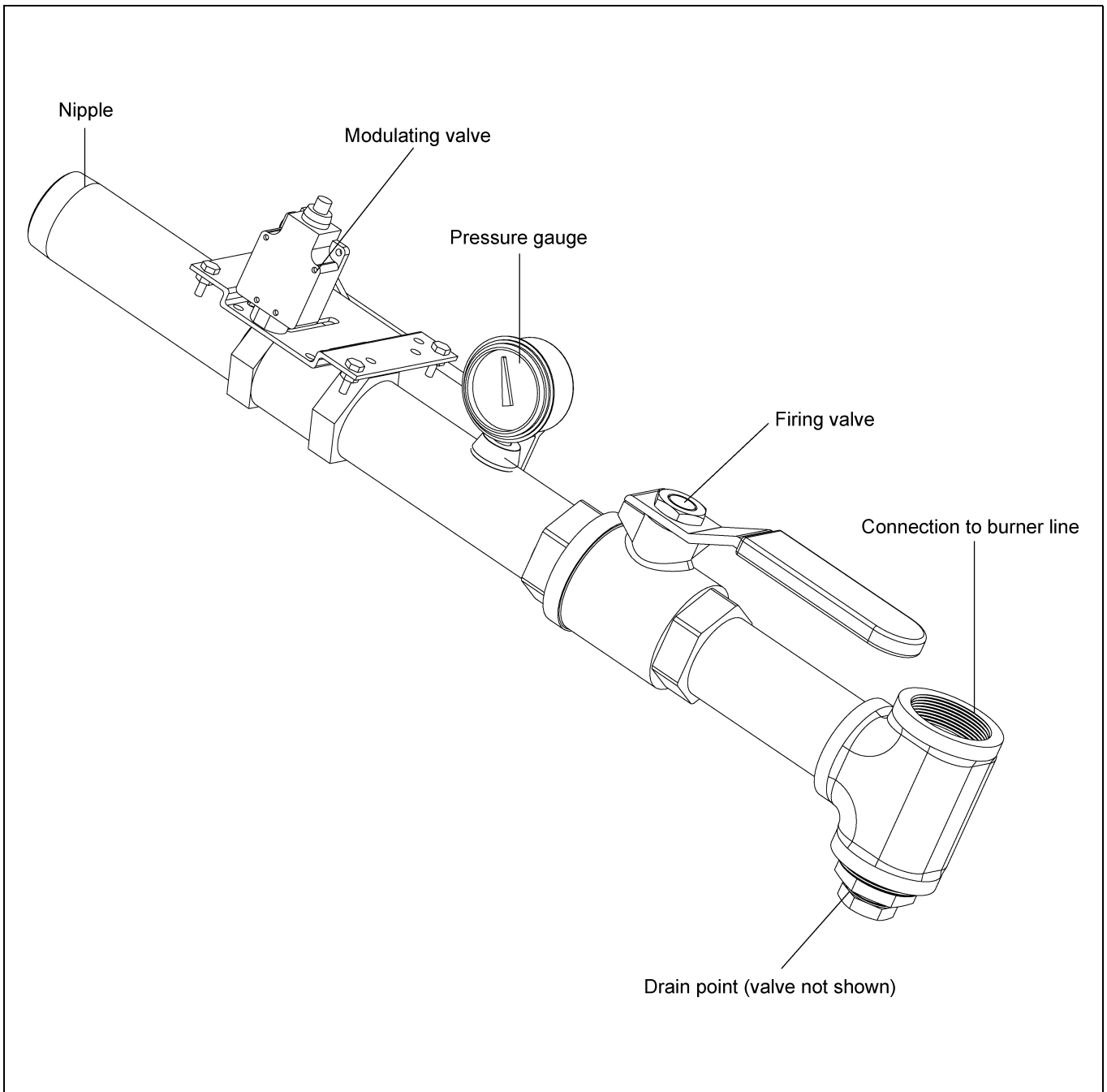

Figure 7G Modulator Section (Modulating Motor Not Shown)

8. Dryer Start-Up and Operation

Drying Temperatures

Drying temperatures differ from crop to crop. Please check the drying temperature does not risk damage to the crop before proceeding.

1. Shelled corn moisture content of 20%-30% (93°C-104°C).
2. Small grain (wheat, oats, barley, milo), 65°C-90°C.
3. Soybeans 50°C-60°C.

Initial Setup Parameters

With the control power ON and the dryer control screen visible.

1. Timer and delay settings: Follow procedures in [Setting the Timers on Page 28](#) to set.
 - a. Load timer.
 - b. Out of grain (OOG) timer.
 - c. Fan delay timer.
 - d. Unload delay timer.

Use default settings as a starting point and adjust subsequently if required.

2. Setting the temperatures. Follow procedure in [Setting the Temperatures on Page 29](#) to set.
 - a. Plenum temperature.
 - b. Grain temperature.

Start-Up



BEFORE STARTING THE DRYER. All safety guards must be in place. All personnel must stay away from the dryer. All access doors must be closed.

1. Make sure pre-season checks have been carried out.
2. Start the control system, with all selector switches OFF.
3. At boot screen ([See Figure 6A on Page 25](#)), press .
4. Turn load auger to MANUAL.
5. Press Start button.
6. Allow dryer to fill.

The dryer is now ready to begin drying.

Continuous Flow Drying Mode Using Advanced Moisture Control

7. Press  and set dryer to CONTINUOUS FLOW. Press .

8. Press .

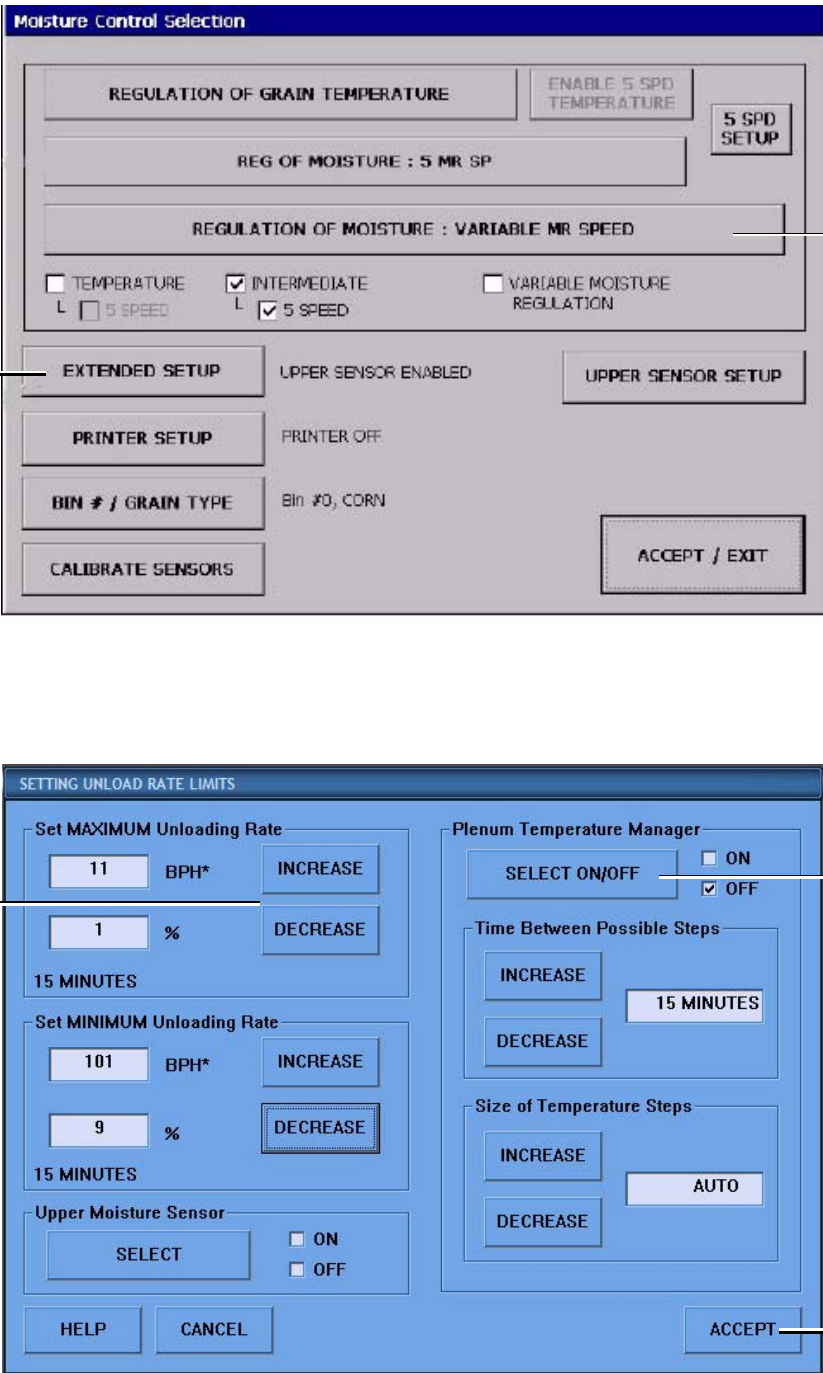

The figure shows two screenshots from a dryer control interface. The top screenshot is titled "Moisture Control Selection" and contains several sections: "REGULATION OF GRAIN TEMPERATURE" with an "ENABLE 5 SPD TEMPERATURE" button; "REG OF MOISTURE : 5 MR SP" with a "5 SPD SETUP" button; "REGULATION OF MOISTURE : VARIABLE MR SPEED" (highlighted with callout 1); a row of checkboxes for "TEMPERATURE", "INTERMEDIATE", and "VARIABLE MOISTURE REGULATION", with "INTERMEDIATE" and "5 SPEED" checked; and a bottom section with buttons for "EXTENDED SETUP", "PRINTER SETUP", "BIN # / GRAIN TYPE", "CALIBRATE SENSORS", and "ACCEPT / EXIT". Callout 2 points to the "EXTENDED SETUP" button.

The bottom screenshot is titled "SETTING UNLOAD RATE LIMITS" and contains: "Set MAXIMUM Unloading Rate" with a value of 11 BPH* and a 1% limit; "Set MINIMUM Unloading Rate" with a value of 101 BPH* and a 9% limit; "Upper Moisture Sensor" with "ON" and "OFF" options; "Plenum Temperature Manager" with "ON" and "OFF" options (callout 4 points to "OFF"); "Time Between Possible Steps" set to 15 MINUTES; and "Size of Temperature Steps" set to AUTO. Callout 3 points to the 11 BPH* value, callout 5 points to the "ACCEPT" button, and callout 4 points to the "OFF" option.

Figure 8A

8. Dryer Start-Up and Operation

9. Set minimum unload rate to 10% and maximum to suit the unload equipment.
10. Set plenum temperature management ON to reduce risk of over-drying when unload rates are limited by a low maximum unloading rate.
11. Return to Moisture Control window and set grain type. Optional printer may also be setup.

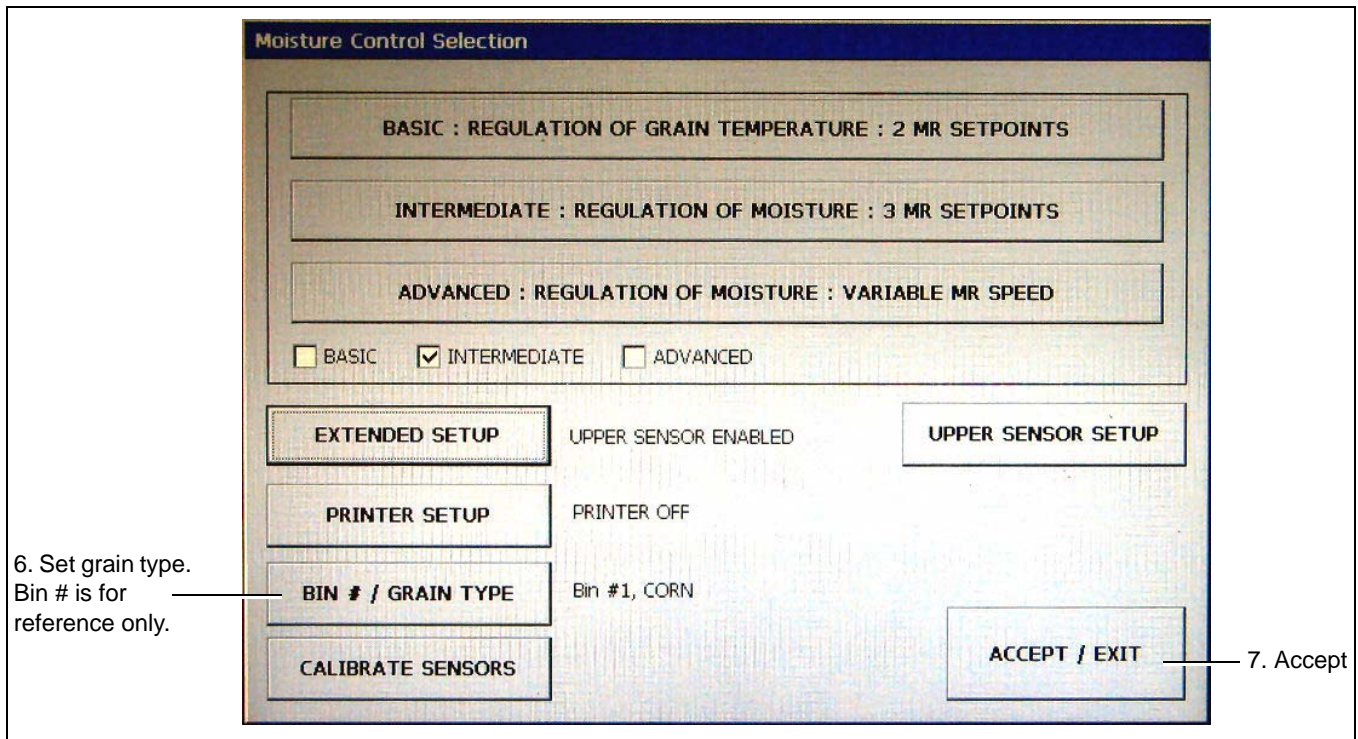

Figure 8B

12. Turn UNLOAD switch OFF.
13. Open fuel supply.
14. Turn LOAD AUGER switch to AUTO.
15. Refer to drying tables [on Pages 50-55](#). Select the initial unload rate for the dryer model, drying temperature and moisture content. Example: Model 1575 drying wheat from 18% to 13% at 80°C initial unload rate = 60.
16. Turn FAN to ON.
17. Turn HEATER to ON.
18. If the dryer is filled with wet grain, let the fan and heater run for 6 minutes per 1% of moisture to be removed.
Example: 18% - 13% = 5% removal. Time = 5 (%) x 6 (min.) = 30 minutes.
This step is only required at initial start-up. Re-starting with dry grain, omit this step.
19. Then, turn UNLOAD AUGER to MANUAL and set the METER ROLL SPEED, (MANUAL SPEED). To do this push on the meter roll adjustment knob and turn to set initial unload rate. Grain should start to run.

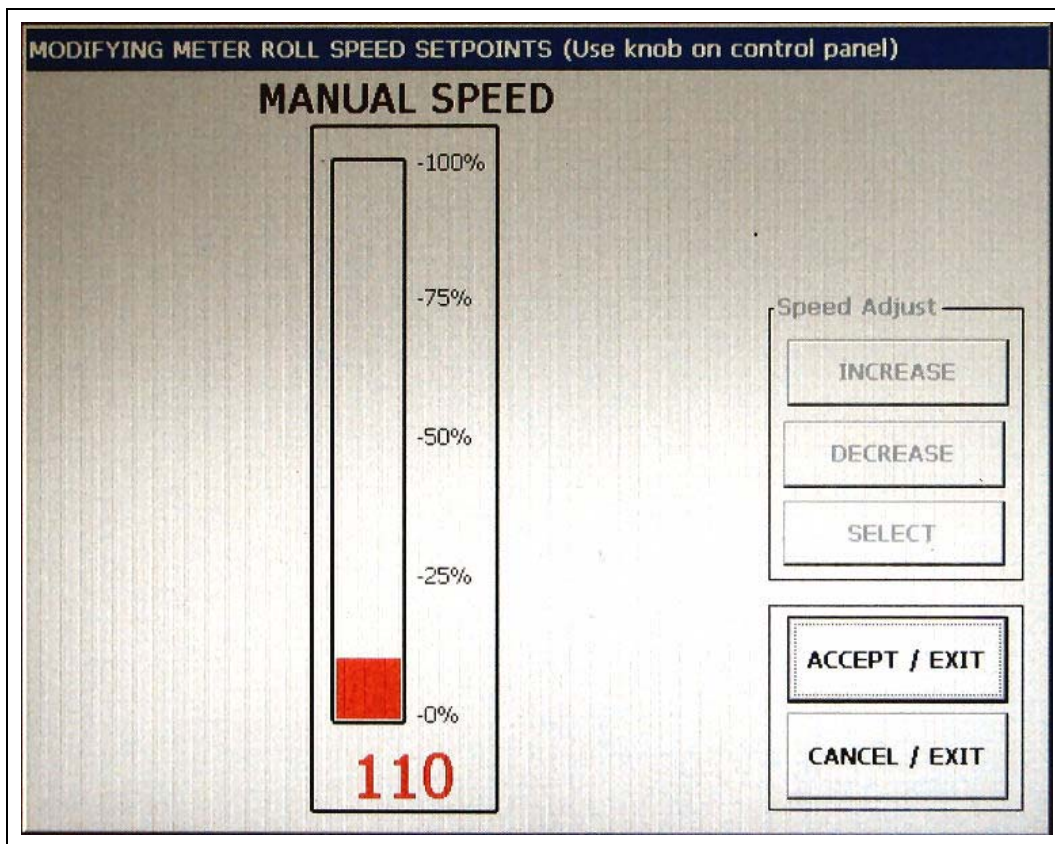
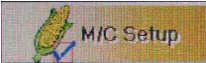
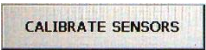

Figure 8C

20. Take three (3) samples with an accurate moisture meter and calculate the average moisture. Calibrate the wet and dry grain sensors until the on screen reading agrees with the average. To do this:

- Press  .
- Press  .
- Calculate difference between actual moisture reading and that on screen.
- Increase or decrease the on screen reading by the calculated difference.

Example:

Actual = 17%;

On screen = 18.3%.

Difference = Actual - On screen = -1.3%

Enter -1.3% in the calibration screen.

8. Dryer Start-Up and Operation

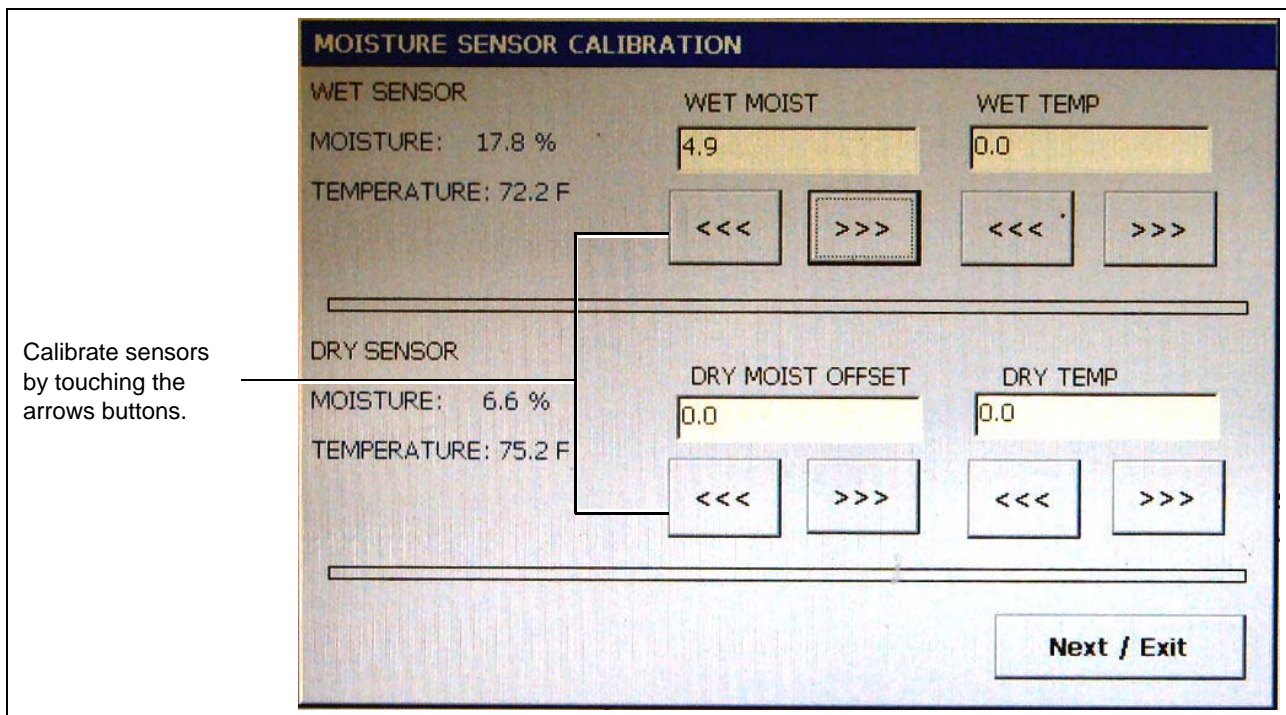

Figure 8D

21. Turn UNLOAD to AUTO. Advanced moisture control is now active.



Figure 8E

22. Set the target moisture and let the dryer run. Make no more changes to allow the system to stabilize.
23. The dryer runs in MANUAL for 30 minutes being switched to AUTO to ensure grain is flowing evenly. The screen displays a timer to show remaining time to full AUTO control.

How the Advanced Moisture Control Works

1. Wet and dry moisture and grain temperature are continually monitored.
2. Control action is mainly based on the dry sensor.
3. Grain flow is increased or decreased to maintain the required dry moisture.
4. The wet sensor and the column grain temperature sensor are intended to detect moisture spikes coming into the dryer so that the moisture controller can react ahead of time. If the wet sensor detects a jump of moisture coming into the dryer, the controller will slow down the unload speed immediately. This process is gradual, to prevent over-drying.
5. MANUAL control is use at the start of drying to allow the controller to gather sufficient information to adequately control.

IMPORTANT: *Once drying has commenced DO NOT make frequent adjustments to drying parameters. This will cause control instabilities and result in over or under drying. Allow the controller to manage the dryer.*

9. Drying Time Tables

Model 1050

Corn

Moisture		75°C	88°C	100°C
In	Out	% Unload Rate	% Unload Rate	% Unload Rate
17%	15%	71	83	95
18%	15%	54	63	72
19%	15%	44	51	58
20%	15%	37	43	50
21%	15%	32	38	43
22%	15%	29	33	38
23%	15%	25	30	34
24%	15%	23	26	30
25%	15%	20	24	27
26%	15%	18	21	24
27%	15%	16	19	22
28%	15%	15	17	20
29%	15%	13	15	18
30%	15%	12	14	16
32%	15%	10	12	13
35%	15%	8	9	11

Wheat, Barley, Milo

Moisture		60°C	70°C	80°C
In	Out	% Unload Rate	% Unload Rate	% Unload Rate
15%	13%	50	59	70
16%	13%	38	44	53
17%	13%	31	36	43
18%	13%	26	31	37
19%	13%	23	27	32
20%	13%	20	24	28
21%	13%	18	21	25
23%	13%	14	17	20
25%	13%	11	13	16

Soybeans

Moisture		50°C	55°C	60°C
In	Out	% Unload Rate	% Unload Rate	% Unload Rate
15%	13%	57	66	74
16%	13%	43	49	55
17%	13%	35	40	45
18%	13%	30	34	38
19%	13%	26	29	33
20%	13%	23	26	29
21%	13%	20	23	26

Model 1260

Corn

Moisture		75°C % Unload Rate	88°C % Unload Rate	100°C % Unload Rate
In	Out			
17%	15%	85	99	--
18%	15%	65	75	86
19%	15%	53	61	69
20%	15%	44	51	60
21%	15%	38	45	51
22%	15%	35	39	45
23%	15%	30	36	40
24%	15%	27	31	36
25%	15%	24	29	32
26%	15%	22	25	29
27%	15%	19	23	26
28%	15%	18	20	24
29%	15%	16	18	21
30%	15%	14	17	19
32%	15%	12	14	15
35%	15%	10	11	13

Wheat, Barley, Milo

Moisture		60°C % Unload Rate	70°C % Unload Rate	80°C % Unload Rate
In	Out			
15%	13%	60	70	83
16%	13%	45	53	63
17%	13%	37	43	51
18%	13%	31	37	44
19%	13%	27	32	38
20%	13%	24	28	33
21%	13%	21	25	30
23%	13%	17	20	24
25%	13%	14	16	19

Soybeans

Moisture		50°C % Unload Rate	55°C % Unload Rate	60°C % Unload Rate
In	Out			
15%	13%	68	78	88
16%	13%	51	58	65
17%	13%	41	47	53
18%	13%	35	40	45
19%	13%	31	35	39
20%	13%	27	31	35
21%	13%	24	28	31
23%	13%	19	22	25
25%	13%	15	18	20

9. Drying Time Tables

Model 1575

Corn

Moisture		75°C	88°C	100°C
In	Out	% Unload Rate	% Unload Rate	% Unload Rate
17%	15%	--	--	--
18%	15%	89	--	--
19%	15%	72	85	97
20%	15%	62	72	82
21%	15%	53	62	71
22%	15%	47	55	63
23%	15%	42	49	56
24%	15%	37	44	50
25%	15%	33	40	45
26%	15%	30	35	40
27%	15%	27	31	36
28%	15%	24	28	32
29%	15%	22	26	29
30%	15%	20	23	26
32%	15%	17	19	22
35%	15%	13	15	17

Wheat, Barley, Milo

Moisture		60°C	70°C	80°C
In	Out	% Unload Rate	% Unload Rate	% Unload Rate
15%	13%	83	97	--
16%	13%	63	73	87
17%	13%	51	60	71
18%	13%	44	51	60
19%	13%	38	44	53
20%	13%	33	39	46
21%	13%	30	35	41
23%	13%	24	28	33
25%	13%	19	22	26

Soybeans

Moisture		50°C	55°C	60°C
In	Out	% Unload Rate	% Unload Rate	% Unload Rate
15%	13%	95	--	--
16%	13%	71	81	91
17%	13%	57	66	74
18%	13%	49	56	63
19%	13%	43	49	55
20%	13%	38	43	48
21%	13%	33	38	43

Model 1875

Corn

Moisture		75°C % Unload Rate	88°C % Unload Rate	100°C % Unload Rate
In	Out			
17%	15%	92	--	--
18%	15%	69	81	92
19%	15%	56	66	75
20%	15%	48	56	64
21%	15%	42	48	56
22%	15%	37	43	49
23%	15%	33	38	43
24%	15%	29	34	39
25%	15%	26	30	35
26%	15%	23	27	31
27%	15%	21	24	28
28%	15%	19	22	25
29%	15%	17	20	23
30%	15%	15	18	21
32%	15%	13	15	17
35%	15%	10	12	14

Wheat, Barley, Milo

Moisture		60°C % Unload Rate	70°C % Unload Rate	80°C % Unload Rate
In	Out			
15%	13%	65	76	90
16%	13%	49	57	68
17%	13%	40	47	55
18%	13%	34	40	47
19%	13%	29	34	41
20%	13%	26	30	36
21%	13%	23	27	32
23%	13%	18	21	26
25%	13%	15	17	21

Soybeans

Moisture		50°C % Unload Rate	55°C % Unload Rate	60°C % Unload Rate
In	Out			
15%	13%	74	84	95
16%	13%	55	63	71
17%	13%	45	51	57
18%	13%	38	43	49
19%	13%	33	38	43
20%	13%	29	34	38
21%	13%	26	30	34
23%	13%	21	24	27
25%	13%	17	19	21

9. Drying Time Tables

Model 20100

Corn

Moisture		75°C	88°C	100°C
In	Out	% Unload Rate	% Unload Rate	% Unload Rate
17%	15%	--	--	--
18%	15%	79	92	--
19%	15%	65	75	86
20%	15%	55	64	73
21%	15%	48	56	64
22%	15%	42	49	56
23%	15%	37	44	50
24%	15%	33	39	44
25%	15%	30	35	40
26%	15%	27	31	36
27%	15%	24	28	32
28%	15%	22	25	29
29%	15%	19	23	26
30%	15%	18	21	24
32%	15%	15	17	20
35%	15%	12	14	16

Wheat, Barley, Milo

Moisture		60°C	70°C	80°C
In	Out	% Unload Rate	% Unload Rate	% Unload Rate
15%	13%	74	87	--
16%	13%	56	65	78
17%	13%	46	53	63
18%	13%	39	45	54
19%	13%	34	39	47
20%	13%	30	35	41
21%	13%	27	31	37
23%	13%	21	25	29
25%	13%	17	20	24

Soybeans

Moisture		50°C	55°C	60°C
In	Out	% Unload Rate	% Unload Rate	% Unload Rate
15%	13%	85	97	--
16%	13%	63	72	81
17%	13%	51	58	66
18%	13%	44	50	56
19%	13%	38	43	49
20%	13%	34	38	43
21%	13%	30	34	38
23%	13%	24	27	31
25%	13%	19	22	25

Model 24100

Corn

Moisture		75°C % Unload Rate	88°C % Unload Rate	100°C % Unload Rate
In	Out			
17%	15%	--	--	--
18%	15%	91	--	--
19%	15%	74	86	99
20%	15%	63	73	84
21%	15%	55	64	73
22%	15%	48	56	64
23%	15%	43	50	57
24%	15%	38	44	51
25%	15%	34	40	45
26%	15%	31	36	41
27%	15%	27	32	37
28%	15%	25	29	33
29%	15%	22	26	30
30%	15%	20	24	27
32%	15%	17	20	22
35%	15%	13	16	18

Wheat, Barley, Milo

Moisture		60°C % Unload Rate	70°C % Unload Rate	80°C % Unload Rate
In	Out			
15%	13%	85	99	--
16%	13%	64	75	89
17%	13%	52	61	73
18%	13%	44	52	62
19%	13%	39	45	54
20%	13%	34	40	47
21%	13%	30	36	42
23%	13%	27	28	37
25%	13%	19	23	27

Soybeans

Moisture		50°C % Unload Rate	55°C % Unload Rate	60°C % Unload Rate
In	Out			
15%	13%	97	--	--
16%	13%	72	82	92
17%	13%	58	67	75
18%	13%	50	57	64
19%	13%	43	50	56
20%	13%	38	44	49
21%	13%	34	39	44
23%	13%	27	31	35
25%	13%	22	25	28



BEFORE SERVICING THE DRYER. Turn OFF and LOCK electrical power at the MAIN DISCONNECT. Turn off fuel supply.

Pre-Seasonal Inspection and Service

1. Inspect control panels for loose wires, rodent damage and accumulated foreign material. Clean and repair as required.
2. Lubricate the blowers, motors and metering system as per lubrication table on [Page 59](#).
3. Check blower belts tension.
4. Inspect and clean the burner. Check that holes in the stainless steel air mixing plates are clear. Clean if required.
5. Check connections to flame rod and spark plug. Clean or replace if necessary.
6. Check gas train drain valve and drain any accumulated water. Close before dryer operation.
7. Check the discharge area is cleaned of stalks and old grain. Inspect the sweeps for excessive wear.
8. Remove covers from burner.

IMPORTANT: *The covers to the discharge sections on the tower dryers must be in place and clamped down at all times when the dryer is in operation. If the cover is off during operation, the vacuum created by the blowers will suck foreign matter from the discharge area and deposit it in the heat section of the dryer plugging the inside screens of the dryer also creating a fire hazard.*

See pre-season check list [on Page 58](#).

Seasonal Inspection and Service

1. Follow lubrication guides in the lubrication table on [Page 59](#).
2. Keep the cooling chamber floor clear of dust and dirt. Check each day before starting drying. Failure to do so could result in a fire. Dirt can be swept into the unload systems.
3. Keep the heat section clear of dust or dirt. Check the hopper divider that separates the heat section from the cooling section to ensure that it remains clean and open.
4. Check the grain discharge area on the dryer. On 'Accutrol' sweep dryers check the sweeps for trash or stalk build ups that could be obstructing grain flow.
5. If undried grain is left in the dryer for more than a week during the drying season, inspect the plenum roof to make sure that there is no wet grain sticking to the roof that could restrict grain flow. When the dryer is re-started make sure that all grain columns are evenly unloading.
6. If the perforated outer sheets on the dryer have become excessively dirty, they may need to be washed off to prevent inhibited airflow.

In Case of Fire

1. Hit emergency stop.
2. Shut off power.
3. Shut off fuel.
4. Do not try to cool a fire by running fan(s).
5. Never run grain from the dryer into the elevator or storage if a fire is known or suspected.
6. Locate the area of the fire.
7. If safe to do so, tackle the fire with a suitable extinguisher. Check for secondary fires.
8. Emergency discharge slide gates at the bottom of each column as well as easy access gates located near the hopper discharge area permit fast dumping of each individual grain column.
9. If in doubt call the fire department.

End of Season Service

1. Always empty the dryer at the end of the drying season.
2. Shut off electrical power and lock.
3. Shut off gas/fuel supply and lock.
4. Clean out the plenum roof grain cushion and remove any grain that may be hanging up on the plenum roof.
5. Make sure the grain exchangers are clean.
6. Clean out the hopper that divides the heat section from the cooling section.
7. Clean the cooling chamber floor.
8. Remove all grain and trash from the metering drum floor. This grain can be raked out by hand by opening the slide gates located in the hopper bottom of the dryer.
9. Make sure gas supply is shut off to the dryer.
10. Open the gas train drain valve located on the bottom of the gas train.
11. Cover the burner with a tarpaulin or plastic.

Pre-Season Service Check List

- Lubricate blower bearings.
- Lubricate blower motor bearings, if needed.
- Check blower belts and adjust if necessary.
- Clean burner ports.
- Inspect flame rod and spark ignitor.
- Check oil levels in gearboxes.
- Inspect divider hopper between heat and cooling section. Clean if necessary.
- Inspect bindicator grain level switches.
- Inspect metering system access door cover seals.
- Lubricate metering system access door cover hold-down latches.
- Lubricate modulator motor linkage.
- Check butterfly operation in modulating valve.
- Check gas pressure gauges.
- Check interior of maxon shut off valves for corrosion. Clean if necessary.
- Clean control and power panels, tighten loose connections and check for leaks.
- Inspect metering systems. Clean accumulated stalks and old grain.
- Start-up dryer and check operating controls.
- Other: Itemize _____

End of Season Shut Down Procedure

- Start unload and empty all grain from dryers.
- Clean out grain cushion (on plenum roof under fill spout). Clean plenum roof.
- Clean off grain exchangers.
- Clean out divider hopper, between heating and cooling section.
- Clean inside cooling sheets and cooling floor.
- Remove all grain and trash from unload section of dryer.
- Open emergency grain discharge doors (and drain doors in zimmerman dryers).
- Open drain valve in gas train.
- Cover burner with a tarp or plastic sheeting.

Location	Instructions	Type of Lubrication	Lubrication Interval
Accutrol (sweep unload) top and bottom drive bearings.	Lubricate slowly until lube shows through seal. Wipe clean.	High quality, grade #2 lithium based grease.	Beginning of season (annually).
Accutrol (sweep unload) coupling hub.	Remove the two (2) lube plugs from the cover. Lubricate slowly until grease begins seeping through relief plug.	High quality, grade #2 lithium based grease.	Beginning of season (annually).
Blower shaft bearings.	Lubricate bottom bearing plug slowly counting the grease gun pump until lube shows through the seal. Wipe clean. Use same # of grease gun pumps for top bearing.	High quality, grade #2 lithium based grease.	Every 4 weeks of dryer operation.
Blower motor bearings.	See motor lubrication procedure below .	High quality, grade #2 lithium based grease.	Every 2 years. (Normal operation, ever 8-10 months continuous operation.)
Metering variable speed drive motor.	See motor lubrication procedure below .	High quality, grade #2 lithium based grease.	Every 2 years. (Normal operation, ever 8-10 months continuous operation.)
Accutrol gearbox.	Grease filled gearbox. Replenish grease to the first stage (upper) reduction mechanism through grease fitting provided (typically quantity = 0.3 oz. of grease).	High quality, grade #2 lithium based grease.	Beginning of season (annually).
<p>*Lubrication of motors - Operate motor for 20 minutes. Clean grease fitting. Remove grease relief plug and using a low pressure grease gun, pump in the required grease. After re-lubricating, allow motor to run for 10 minutes before replacing relief hardware. DO NOT over grease.</p>			

12. Error Messages

Safety Circuit Shut Down Messages

Shut down warning window: Touch the Help button to display the shut down help window. (See Figure 12A.)

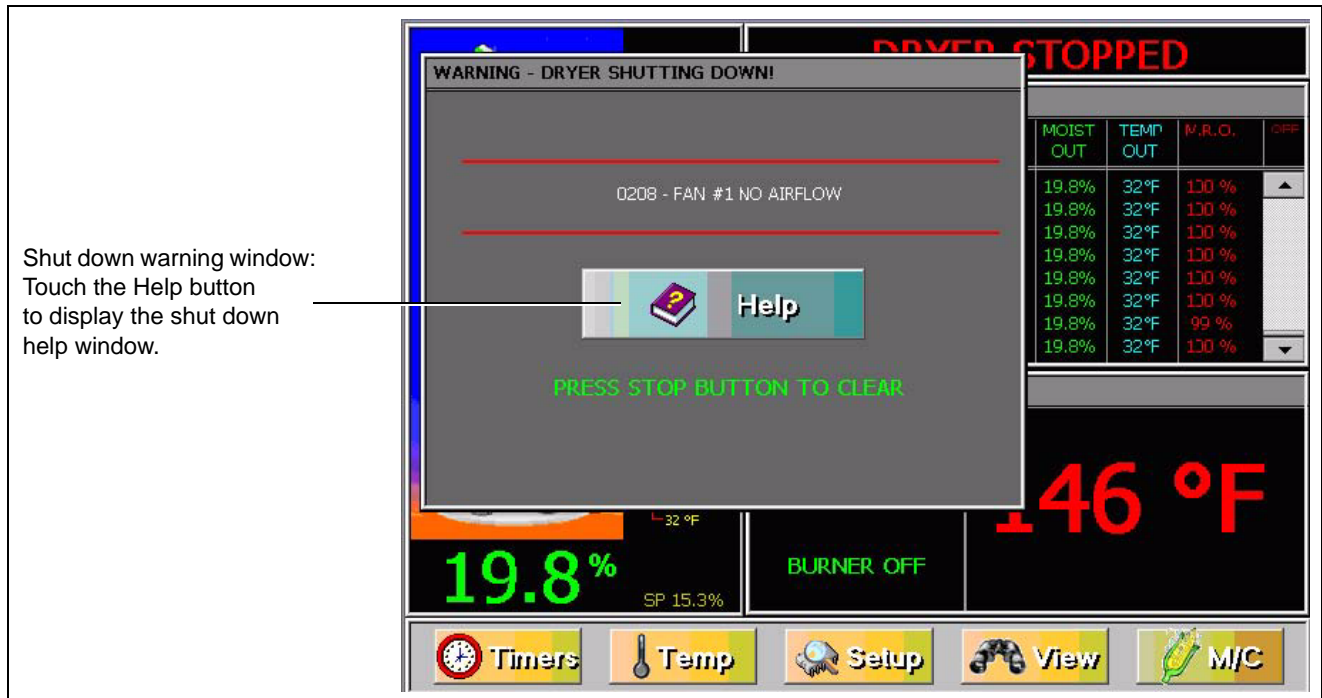

Figure 12A

Fan/Heater Generated Errors

Air Switch Stuck

Switch is stuck closed when fan is OFF.

Fan Loss of Airflow

Air switch has stopped sensing air pressure during fan operation.

Fan No Airflow

Air switch is not sensing air pressure after fan start-up.

Flame Loss

Flame signal was lost during burner operation.

Grain Temp Short

Grain temperature sensor is showing short circuit.

Grain Overheat

Grain temperature has exceeded 100°C. Grain flow may be blocked or metering speed too slow. This re-sets once cooled, but the burner must be re-cycled to enable re-start.

Housing High-Limit

Heater housing has exceeded 93°C and burner has locked out. This must be manually re-set once the cause has been removed.

Ignition Failure

Burner failed to light. Burner control will lock-out and must be re-set. Check flame sensor.

Illegal Flame

Burner control is seeing flame when burner is OFF. Check for leaking safety valve. Check for fire.

Motor Overload

Motor thermal overload has opened load on one or other motor. Must be manually re-set.

Vapor High-Limit

LPG vapor has exceed safe temperature and burner has locked out. Vaporizer may need to be adjusted. Burner must be re-set before it will relight.

Input/Output Generated Errors

Air System Failure

Safety on an air conveying system (integrated into the dryer safety circuit) has opened. The air system safety connections are located in the upper control box on the terminal strip on terminal J1-10 on the Input/Output board and must see 12 VDC.

Aux Load Overload

The motor overload relay has tripped on the aux load motor circuit located in the upper control box.

Aux Unload Overload

The motor overload relay has tripped on the aux unload motor circuit located in the upper control box.

Load Motor Overload

The motor overload has tripped on the load motor overload located in the upper control box.

Meter Rolls Failed

Metering rolls are not turning.

Out of Grain

The dryer has run low on grain and the out of grain timer has timed out, shutting the dryer down.

12. Error Messages

Unload Motor Overload

The motor overload has tripped on the unload motor overload located in the upper control box.

User Safety

On CE dryers this safety indicates that the valve proving system has failed to prove the main safety valves. Valves may need to be replaced or be re-seated.

Master Display Generated Errors

Cont-Batch Mode Chng

Dryer was switch from continuous flow to batch or vice versa whilst running.

Network Failed FH x

Network communications have been lost to the Fan/Heater board. Check cables. *(See Figure 12B.)*

Network Failed Input/Output

Network connections have been lost between the Main I/O and Lower control box board. Check cables.

Network Failed Mast

Network connections have been lost between Master Display board (lower control panel) and Input/Output board (upper control panel door) and the Fan/Heater boards. Check cables.

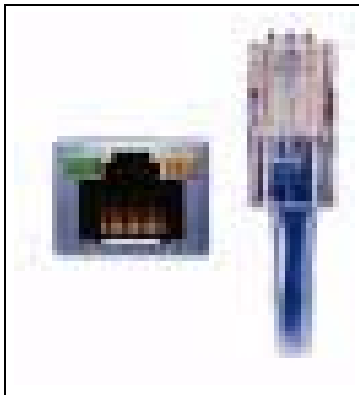

Figure 12B

Plenum Temp Open x

Plenum temperature sensor is showing open circuit.

Plenum Temp Short x

Plenum temperature sensor is showing short circuit.

Plenum x Overheat

Plenum has exceeded 154°C and burner has locked out.

Earth Wiring

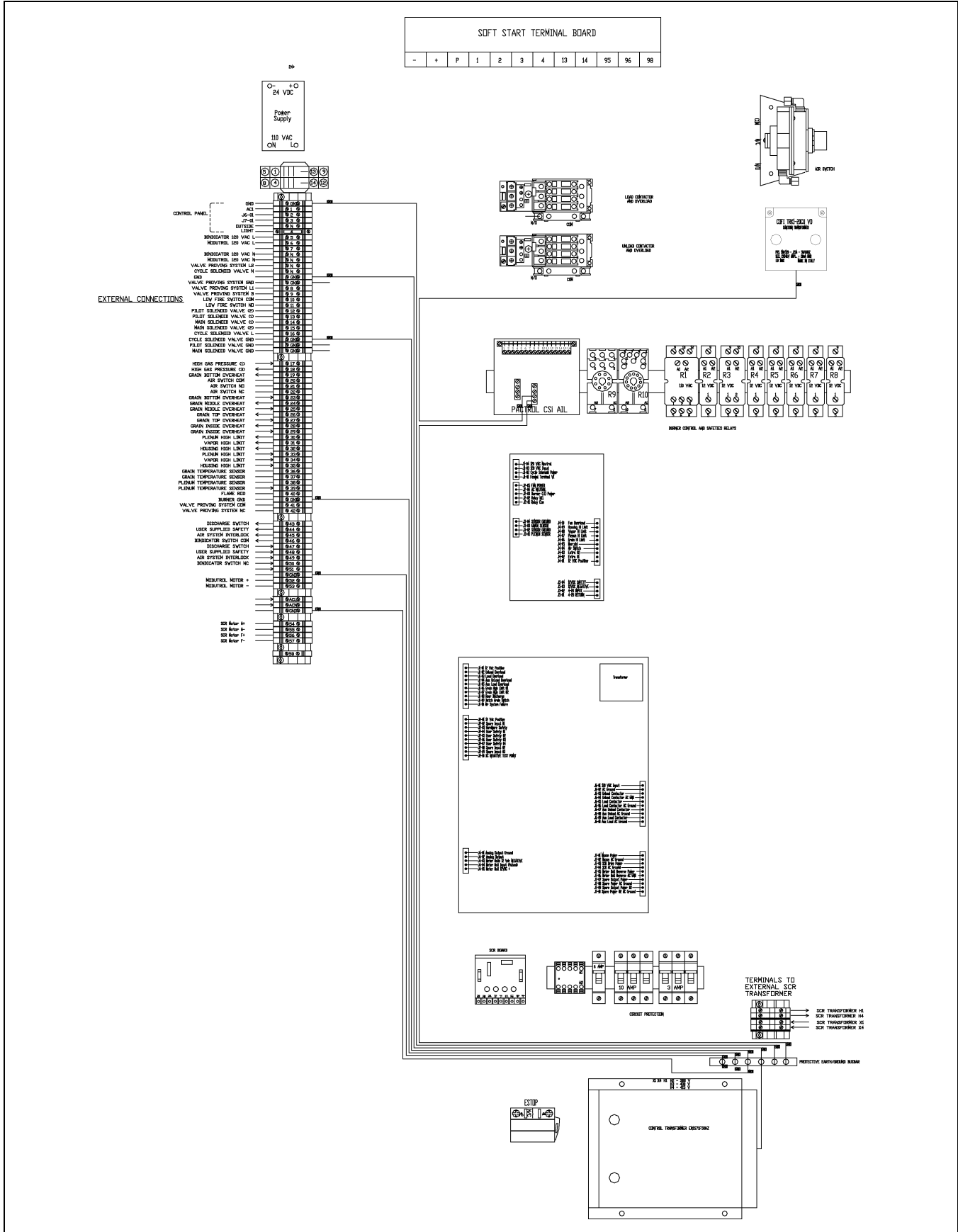

Terminal Strip

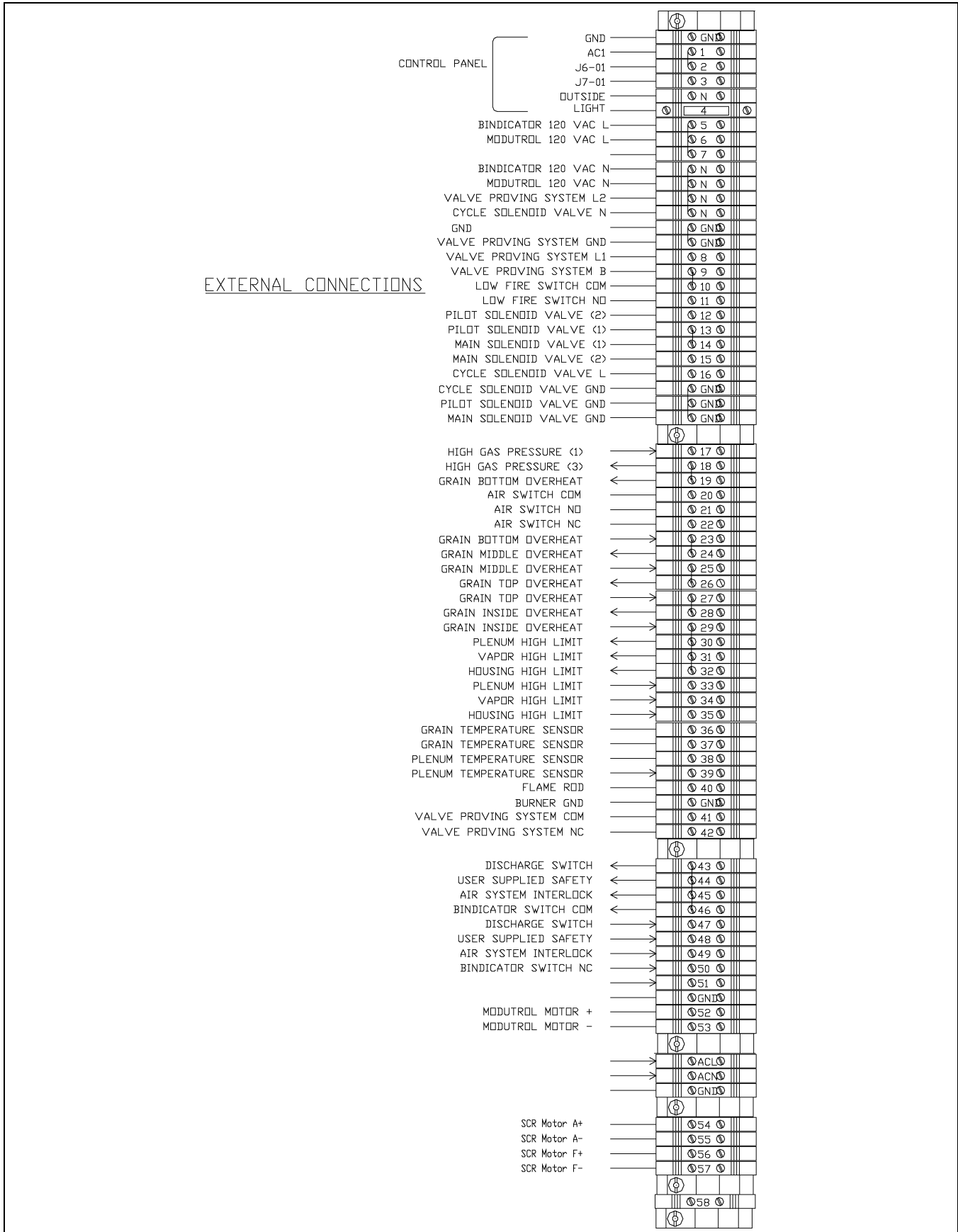

13. Wiring Diagrams

Burner Control Safety Relay Schematic

NOTES:

1. For direct spark (non-pilot) ignition patrol aml version to be used.
2. On direct spark ignition FSC 9 is main valve. Do not connect FSC 11.
3. Burner control has 35 seconds pre-ignition purge.
4. Automatic low-fire start for both high-low and modulating burners.
5. Refer to terminals layout drawing.

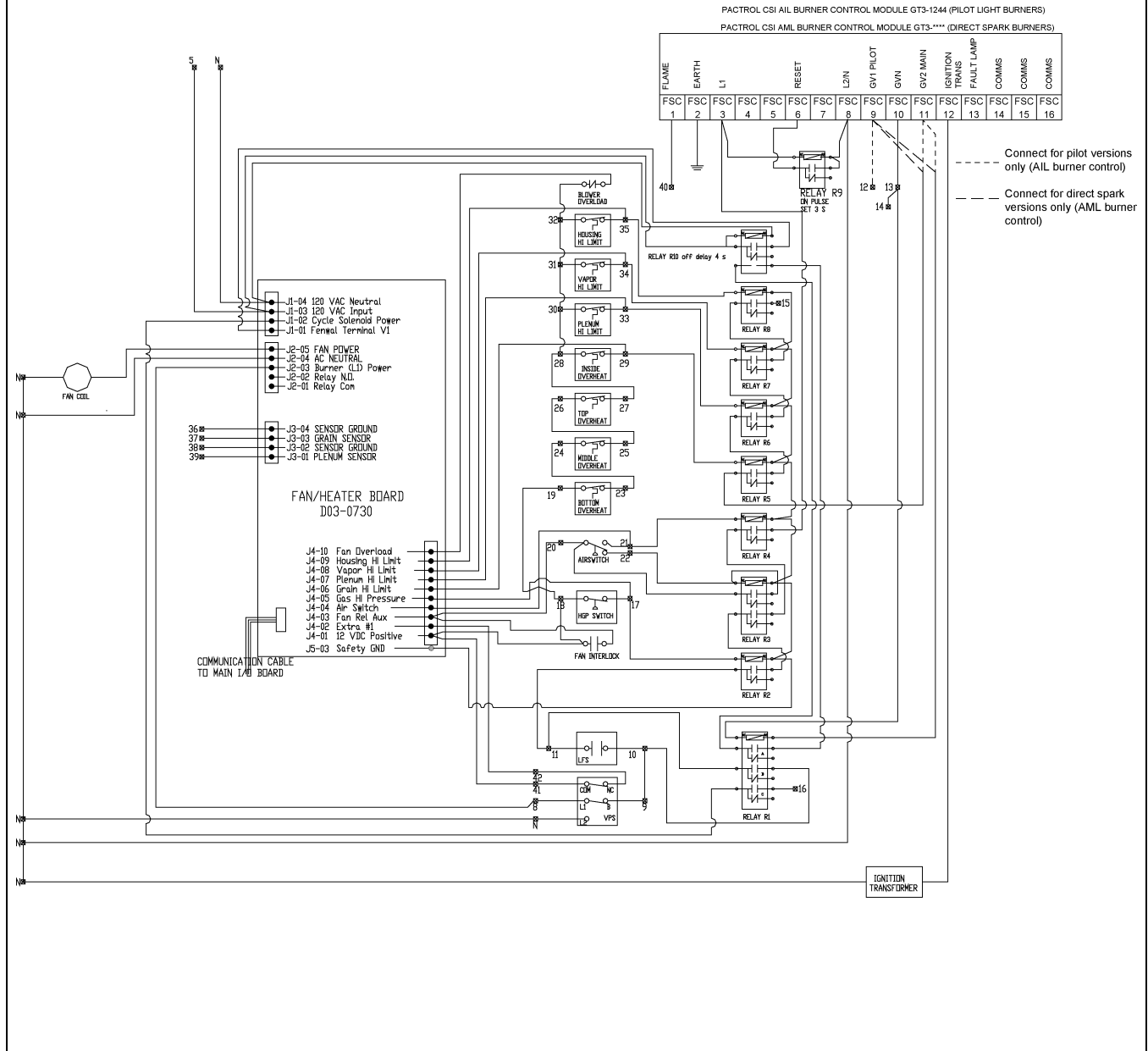

GSI Group, LLC Limited Warranty

The GSI Group, LLC ("GSI") warrants products which it manufactures to be free of defects in materials and workmanship under normal usage and conditions for a period of 12 months after sale to the original end-user or if a foreign sale, 14 months from arrival at port of discharge, whichever is earlier. The end-user's sole remedy (and GSI's only obligation) is to repair or replace, at GSI's option and expense, products that in GSI's judgment, contain a material defect in materials or workmanship. Expenses incurred by or on behalf of the end-user without prior written authorization from the GSI Warranty Group shall be the sole responsibility of the end-user.

Warranty Extensions:

The Limited Warranty period is extended for the following products:

	Product	Warranty Period
AP Fans and Flooring	Performer Series Direct Drive Fan Motor	3 Years
	All Fiberglass Housings	Lifetime
	All Fiberglass Propellers	Lifetime
Cumberland Feeding/Watering Systems	Feeder System Pan Assemblies	5 Years **
	Feed Tubes (1-3/4" and 2.00")	10 Years *
	Centerless Augers	10 Years *
	Watering Nipples	10 Years *
Grain Systems	Grain Bin Structural Design	5 Years
Grain Systems Farm Fans Zimmerman	Portable and Tower Dryers	2 Years
	Portable and Tower Dryer Frames and Internal Infrastructure †	5 Years

* Warranty prorated from list price:
 0 to 3 years - no cost to end-user
 3 to 5 years - end-user pays 25%
 5 to 7 years - end-user pays 50%
 7 to 10 years - end-user pays 75%

** Warranty prorated from list price:
 0 to 3 years - no cost to end-user
 3 to 5 years - end-user pays 50%

† Motors, burner components and moving parts not included. Portable dryer screens included. Tower dryer screens not included.

GSI further warrants that the portable and tower dryer frame and basket, excluding all auger and auger drive components, shall be free from defects in materials for a period of time beginning on the twelfth (12th) month from the date of purchase and continuing until the sixtieth (60th) month from the date of purchase (extended warranty period). During the extended warranty period, GSI will replace the frame or basket components that prove to be defective under normal conditions of use without charge, excluding the labor, transportation, and/or shipping costs incurred in the performance of this extended warranty.

Conditions and Limitations:

THERE ARE NO WARRANTIES THAT EXTEND BEYOND THE LIMITED WARRANTY DESCRIPTION SET FORTH ABOVE. SPECIFICALLY, GSI MAKES NO FURTHER WARRANTY OF ANY KIND, EXPRESS OR IMPLIED, INCLUDING, WITHOUT LIMITATION, WARRANTIES OF MERCHANTABILITY OR FITNESS FOR A PARTICULAR PURPOSE OR USE IN CONNECTION WITH: (I) PRODUCT MANUFACTURED OR SOLD BY GSI OR (II) ANY ADVICE, INSTRUCTION, RECOMMENDATION OR SUGGESTION PROVIDED BY AN AGENT, REPRESENTATIVE OR EMPLOYEE OF GSI REGARDING OR RELATED TO THE CONFIGURATION, INSTALLATION, LAYOUT, SUITABILITY FOR A PARTICULAR PURPOSE, OR DESIGN OF SUCH PRODUCTS.

GSI shall not be liable for any direct, indirect, incidental or consequential damages, including, without limitation, loss of anticipated profits or benefits. The sole and exclusive remedy is set forth in the Limited Warranty, which shall not exceed the amount paid for the product purchased. This warranty is not transferable and applies only to the original end-user. GSI shall have no obligation or responsibility for any representations or warranties made by or on behalf of any dealer, agent or distributor.

GSI assumes no responsibility for claims resulting from construction defects or unauthorized modifications to products which it manufactured. Modifications to products not specifically delineated in the manual accompanying the equipment at initial sale will void the Limited Warranty.

This Limited Warranty shall not extend to products or parts which have been damaged by negligent use, misuse, alteration, accident or which have been improperly/inadequately maintained. This Limited Warranty extends solely to products manufactured by GSI.

Prior to installation, the end-user has the responsibility to comply with federal, state and local codes which apply to the location and installation of products manufactured or sold by GSI.

This equipment shall be installed in accordance with the current installation codes and applicable regulations which should be carefully followed in all cases. Authorities having jurisdiction should be consulted before installations are made.

G S I G R O U P



GSI Group
1004 E. Illinois St.
Assumption, IL 62510-0020
Phone: 1-217-226-4421
Fax: 1-217-226-4420
www.gsiag.com