



# Tower Grain Dryer - Electrical

Installation Manual

PNEG-708

Version: 3.0

Date: 05-28-21



---

**All information, illustrations, photos, and specifications in this manual are based on the latest information available at the time of publication. The right is reserved to make changes at any time without notice.**

# Contents

<b>Chapter 1 Introduction</b> .....	<b>5</b>
<b>Chapter 2 Safety</b> .....	<b>6</b>
Safety Guidelines .....	6
Cautionary Symbols Definitions .....	7
Safety Cautions .....	8
Safety Sign-Off Sheet .....	13
Plan Ahead for Electrical Safety .....	14
Electrical Power Supply .....	14
Material Safety Data Sheets (MSDS) .....	14
<b>Chapter 3 Safety Decals</b> .....	<b>15</b>
Apply Safety Decals .....	16
Safety Decal # DC-GBC-1A .....	19
Safety Decal # DC-889 .....	20
Safety Decals # DC-985, DC-987 and DC-988 .....	21
Safety Decals # DC-989, DC-990 and DC-991 .....	22
Safety Decals # DC-1061, DC-1063 and 420-1473-8 .....	23
Safety Decals # DC-1063 and DC-1064 .....	24
Safety Decals # DC-1223 and DC-1317 .....	25
Information Decals .....	26
<b>Chapter 4 Overview and Planning</b> .....	<b>27</b>
Installation Summary .....	27
Planning Electrical Control System Examples .....	31
Planning Conduit Examples (10' Lengths, Diameter 1/2", 1" and 2-1/2") .....	37
Planning Knock Outs Examples .....	41
Planning Wiring Examples .....	44
<b>Chapter 5 Fan Motors</b> .....	<b>47</b>
Fan Motors Wiring and Installing Air Switch Tubing .....	47
<b>Chapter 6 Air Switches</b> .....	<b>53</b>
Install 3/8" Copper Tubing for Air Switches .....	53
<b>Chapter 7 Metering Device Motor</b> .....	<b>57</b>
<b>Chapter 8 Interior High-Limits, Thermostat, Plenum Temperature Sensor</b> .....	<b>62</b>
<b>Chapter 9 Exterior High-Limits</b> .....	<b>67</b>
Exterior High-Limits (Overheats) .....	67
<b>Chapter 10 Sensors</b> .....	<b>70</b>
Indicator(s) and Grain Temperature Sensors (RTDs) .....	70
Indicator(s) .....	70
Grain Temperature Sensors Probe .....	72
Moisture Sensor Kit .....	77
<b>Chapter 11 Ignitor and Flame Sensor</b> .....	<b>89</b>
<b>Chapter 12 Fuel Train</b> .....	<b>96</b>
Fuel Train Installations (Natural Gas or Liquid Propane) .....	96
Fuel Train - Demonstration Close Ups .....	97
Fuel Train - Demonstration Close Ups (Continued) .....	100
Pilot Fuel Line .....	100
Pilot Fuel Line (Continued) .....	101
Pilot Fuel Line (Continued) .....	103
Fuel Train Wiring .....	103
Example - Installing Conduit for Fuel Train Wiring .....	104

# Table of Contents

---

<b>Chapter 13</b>	<b>Lights and Safety Horn</b> .....	<b>111</b>
	Work Light, Safety Light and Safety Horn .....	111
<b>Chapter 14</b>	<b>Appendix A</b> .....	<b>113</b>
	Recommended Tools and Equipment List .....	113
<b>Chapter 15</b>	<b>Appendix B</b> .....	<b>115</b>
	Hardware .....	115
<b>Chapter 16</b>	<b>Appendix C</b> .....	<b>120</b>
<b>Chapter 17</b>	<b>Appendix D</b> .....	<b>122</b>
	Tower Dryer Control Panel Wiring Diagram .....	122
	Gas Train Wiring Schematic Diagram .....	124
<b>Chapter 18</b>	<b>Appendix E</b> .....	<b>126</b>
	Fuel Train with Pilot Fuel Line .....	126
<b>Chapter 19</b>	<b>Appendix F</b> .....	<b>127</b>
	Cutaway - Ignitor and Flame Sensor Conduits .....	127
	Sensor and Conduit Location .....	128
<b>Chapter 20</b>	<b>Appendix G</b> .....	<b>129</b>
	Exterior Sensors Conduits .....	129
<b>Chapter 21</b>	<b>Appendix H</b> .....	<b>130</b>
	Tower Cutaway .....	130
<b>Chapter 22</b>	<b>Appendix I</b> .....	<b>132</b>
	Glossary of Installation Terms .....	132
<b>Chapter 23</b>	<b>Appendix J</b> .....	<b>133</b>
	U.S. to Metric Conversion Tables .....	133
<b>Chapter 24</b>	<b>Appendix K</b> .....	<b>135</b>
	Dryer Decals Used on Structure .....	135
<b>Chapter 25</b>	<b>Warranty</b> .....	<b>137</b>

**READ THIS MANUAL and construction manual PNEG-707** carefully to learn how to properly use and install equipment. Failure to do so could result in personal injury or equipment damage.

As with all GSI shipments, inspect shipment immediately. The customer is responsible for ensuring that all quantities are correct. The customer should report and note any damage or shortage on the bill of lading to justify their claim to the transport company.

**THIS MANUAL SHOULD BE CONSIDERED** a permanent part of your equipment and should be easily accessible when needed.

This warranty provides you the assurance that the company will back its products when defects appear within the warranty period. In some circumstances, the company also provides field improvements, often without charge to the customer, even if the product is out of warranty. Should the equipment be abused, or modified to change its performance beyond the factory specifications, the warranty will become void and field improvements may be denied.



Figure 1A

### Safety Guidelines

Safety guidelines are general-to-specific safety rules that must be followed at all times. This manual is written to help you understand safe operating procedures and problems that can be encountered by the operator and other personnel when using this equipment. Read and save these instructions.

As owner or operator, you are responsible for understanding the requirements, hazards, and precautions that exist and to inform others as required. Unqualified persons must stay out of the work area at all times.

Alterations must not be made to the equipment. Alterations can produce dangerous situations resulting in **SERIOUS INJURY** or **DEATH**.

This equipment must be installed in accordance with the current installation codes and applicable regulations, which must be carefully followed in all cases. Authorities having jurisdiction must be consulted before installations are made.

When necessary, you must consider the installation location relative to electrical, fuel and water utilities.

Personnel operating or working around equipment must read this manual. This manual must be delivered with equipment to its owner. Failure to read this manual and its safety instructions is a misuse of the equipment.

**ST-0001-4**

## Cautionary Symbols Definitions

Cautionary symbols appear in this manual and on product decals. The symbols alert the user of potential safety hazards, prohibited activities and mandatory actions. To help you recognize this information, we use the symbols that are defined below.



This symbol indicates an imminently hazardous situation which, if not avoided, **will result in serious injury or death.**



This symbol indicates a potentially hazardous situation which, if not avoided, **can result in serious injury or death.**



This symbol indicates a potentially hazardous situation which, if not avoided, **can result in minor or moderate injury.**



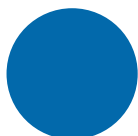
This symbol is used to address practices not related to personal injury.



This symbol indicates a general hazard.



This symbol indicates a prohibited activity.



This symbol indicates a mandatory action.

ST-0005-2

### Safety Cautions

#### Use Personal Protective Equipment

- Use appropriate personal protective equipment:

**Eye Protection**



**Respiratory Protection**



**Foot Protection**



**Hearing Protection**



**Head Protection**



**Fall Protection**



**Hand Protection**



- Wear clothing appropriate to the job.
- Remove all jewelry.
- Tie long hair up and back.

ST-0004-1

#### Follow Safety Instructions

- **Warning:** If the information in the manual is not followed exactly, a fire or explosion can result, causing property damage, personal injury or loss of life.
- Carefully read all safety messages in this manual and safety signs on your machine. Keep signs in good condition. Replace missing or damaged safety signs. Be sure new equipment components and repair parts include the current safety signs. Replacement safety signs are available from the manufacturer.
- Learn how to operate the machine and how to use controls properly. Do not let anyone operate without instruction.
- If you do not understand any part of this manual or need assistance, contact your dealer.
- Retain these instructions for future reference.



ST-0025-3



### Install and Operate Gas-Fired Equipment Properly

- Gas-fired equipment should be installed by a qualified pipe fitter and must conform with local codes.
- For Canada: The equipment shall be installed in accordance with the *Natural Gas and Propane Installation Code, CSA B149.1*, or the *Propane Storage and Handling Code, CSA B149.2*, or applicable provincial regulations, which should be carefully followed in all cases. Authorities having jurisdiction should be consulted before installations are made.
- For the United States: The equipment shall be installed in accordance with the *National Fuel Gas Code ANSI Z223.1/NFPA 54*.



ST-0016-2

### For Your Safety

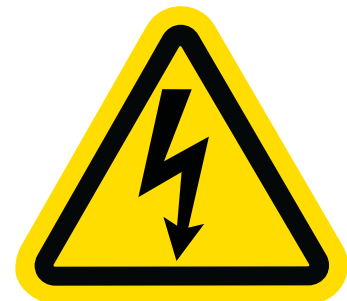
- If you smell gas:
  - Do not try to light any appliance.
  - Extinguish any open flames.
  - Do not touch any electrical switch.
  - Immediately call your gas supplier. Follow the gas supplier's instructions.
  - If you cannot reach your gas supplier, call the fire department.
- The use and storage of gasoline and other flammable vapors and liquids in open containers in the vicinity of this appliance is hazardous.
- Improper installation, adjustment, alteration, service or maintenance can cause property damage, injury or death. Read the installation, operating and maintenance instructions thoroughly before installing or servicing this equipment. Installation and service must be performed by a qualified installer, service agency or the gas supplier.



ST-0024-1

### Install and Operate Electrical Equipment Properly

- Electrical controls must be installed by a qualified electrician and must meet the standards set by applicable local codes (National Electrical Code for the US, Canadian Electric Code, or EN60204 along with applicable European Directives for Europe).
- Lock-out power source before making adjustments, cleaning, or maintaining equipment.
- Make sure all equipment and bins are properly grounded.



ST-0075-1

## 2. Safety

### Maintain Equipment and Work Area

- Understand service procedures before doing work.
- Keep area clean and dry.
- Do not service equipment while it is operating. Disconnect and lock-out power and fuel supply before entering equipment or before performing maintenance.
- Keep your equipment in proper working condition. Replace worn or broken parts immediately.
- Depressurize the fuel train before disassembling for service.
- Allow the fan to operate for 20 minutes with the burner off to purge products of combustion and to cool the components before entering.
- Check regularly for any developing gas plumbing leaks. Do not operate the dryer if any gas leak is detected. Shut down and repair before further operation.



ST-0030-2

### Exercise Caution When Drying Flammable Grains

- Be aware that some grains are highly flammable including, but not limited to, rapeseed, canola, linseed, sunflower and milo.
- All grain and seed must be whole (minimal cracking or crushing), clean, and dust free before drying.
- Avoid dust and chaff from being drawn into the fan and heater.
- To reduce risk of fire, keep the fan, heater, drying plenum, and ducts clean at all times.
- In the event of a fire (or suspected fire):
  1. Shut down the entire dryer.
  2. Turn off fuel at the tank or supply valve.
  3. Shut off and lock electrical power.
  4. Evacuate the area.
  5. Call the fire department.



ST-0032-1

### Fall Hazard

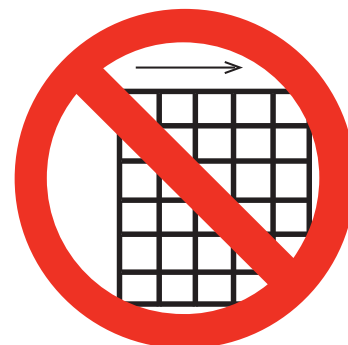
- Keep access door closed while on a platform to avoid falls.
- Always use proper personal protective equipment and proper clothing when using equipment. Failure to follow safety precautions can result in severe injury or death.



ST-0042-2

### Maintain Equipment and Work Area

- Equipment is intended for the use of grain drying only. Any other use is a misuse of this equipment.
- The operating instructions in this manual pertain to the common cereal grains as indicated. When drying any other grain, contact GSI for additional recommendations.
- Be certain that capacities of auxiliary conveyors are matched to dryer metering capacities.
- On LP fired units, set pressure regulator to avoid excessive gas pressure applied to the burner during ignition and operation. Do not exceed maximum recommended drying temperatures.
- Equipment has sharp edges that can cause serious injury. To avoid injury, handle sharp edges with caution and use proper protective clothing and equipment at all times.
- All guards must be in place before and during operation. Images of guards removed in this manual are for illustration purposes only.
- Use caution when working around high-speed fans, gas burners, augers and auxiliary conveyors which can start automatically.
- Keep hands, feet, and clothing away from moving parts.
- Do not bypass any safety device or interlock.
- Do not enter the dryer or bin while it is operating.
- Do not operate in an area where combustible material will be drawn into the dryer.



ST-0034-2

### Stay Clear of Hoisted Equipment

- Always use proper lifting or hoisting equipment when assembling or disassembling equipment
- Do not walk or stand under hoisted equipment.
- Always use sturdy and stable supports when needed for installation. Not following these safety precautions creates the risk of falling equipment, which can crush personnel and cause serious injury or death.



ST-0047-1

## 2. Safety

### Confined Space Hazards and Entry Procedures

- Note that the interior of this equipment is considered a confined space. Maintenance of this equipment can require access to the confined space.
- Access doors must be shut and locked except when access is required.
- Doors giving access to dangerous equipment must be safety interlocked.
- The following entry procedures must be followed:
  - Be aware of all possible hazards present inside the confined space and wear personal protective equipment (PPE) as needed.
  - Complete a permit to work and follow all permit required confined space entry procedures defined by the site manager.
  - Make sure that the area has been purged of any hazardous products or gases. Check the atmosphere for harmful gases or vapors with a suitable gas analyzer and make sure levels are safe before entering.
  - Do not smoke or use naked flames.
  - Lock out and tag out power supplies and fuel supplies to all equipment.
  - Do not work alone. Work in teams of at least three so that help is immediately available in the event of an emergency.
  - Confirm that all personnel have safely exited the equipment and tools have been recovered once work is complete.



ST-0055-1

### Fall Hazard

- Ladders, stairways and platforms are for use by competent and trained personnel only. Do not allow children or other unauthorized persons to have access to the equipment.
- Access to the equipment must be restricted by the use of security fencing and lockable gates.
- Lower sections of ladders must be fitted with a lockable safety gate to prevent unauthorized access.
- Make sure that hot surfaces have had adequate time to cool before working on or in the equipment.
- Lock out and tag out power supplies and fuel supplies to all equipment.
- Do not attach lifting equipment to ladders or platforms.
- Do not go outside of the safety rails provided on elevated platforms.
- Do not work at heights during high winds, rain, snow, or ice storms.



ST-0056-1



### Plan Ahead for Electrical Safety

- Read this entire manual before beginning electrical installations.
- Plan ahead to assure safe and proper installation of all parts.
- Electrical safety starts with the design of the facility. Proper design provides for the correct relationship between energy supplies, existing equipment and structures.
- Technical support is available at all times for support should any un-for seen complications arise.
- Use common sense when installing electrical connections.
- Obtain any permits and/or licenses required for work at the electrical installation location.
- Make sure power supply is turned OFF. Lock and tag the equipment on which you are working. Test to make sure it is *really* locked out.
- Check the work.

**NOTE:** *Electrical wiring should be installed to tower dryers in accordance with national and local codes. The United States National Electric Code (NEC) and/or the Canadian Standards Association (CSA) code provide basic standards for the design and installation of the electrical system.*

### Electrical Power Supply

GSI recommends you contact your local power company and request that a representative inspect the dryer installation to ensure that the wiring is compatible with the power company's system and that adequate power will be supplied to the dryer. ([See Page 118.](#))

**NOTE:** *If power being supplied by local supply company becomes an issue or is known to be an issue, please consult with GSI technical service immediately for possible available solutions.*

### Material Safety Data Sheets (MSDS)

MSDS are available upon request.

Some of the required safety decals are placed on the dryer before shipping. The remainder of the decals are placed on the dryer during electrical installations. The purpose of the safety decals is to immediately alert all personnel to the hazards of operating a grain dryer. However, safety decals do not replace the need for all personnel to know and understand safe dryer operations and requirements. **Read the “Tower Dryer Operations and Service Manual”**.

**NOTE:** *Safety decals should be read and understood by all people in or around the dryer area.*

Safety decals are shown on [Pages 19-26](#). They identify and give the location of all safety decals to be displayed on every tower dryer. Safety decals are listed in numerical order.

If the safety decals on the following pages are not on the dryer or if they are damaged, immediately contact GSI Group for replacement safety decals.

#### **GSI Decals**

1004 E. Illinois St.  
Assumption, IL. 62510  
Phone: 1-217-226-4421

### 3. Safety Decals

## Apply Safety Decals

### DC-GBC-1A, DC-889, DC-985, DC-987 and DC-988

The “Safety Decals on Dryer” section in the beginning of this manual identifies all safety decals and gives their location on the tower grain dryer. The safety decals are listed in numerical order.

The purpose of the safety decals is to immediately alert all personnel working near the tower dryer to the hazards of an operating dryer.

If the required safety decals are not available or if they are damaged, immediately contact GSI Group for replacement safety decals.

For proper placement of safety decals, refer to the “Safety Decals on Dryer” section in this manual.

## WARNING

Rotating flying could  
kill or dismember.

Flowing material could  
trap and suffocate.

Crusted material could  
collapse and suffocate.

### Keep clear of all augers. DO NOT ENTER this bin!

If you must enter the bin:

1. Shut off and lock out all power.
2. Use a safety harness and safety line.
3. Station another person outside the bin.
4. Avoid the center of the bin.
5. Wear proper breathing equipment or respirator.

**Failure to heed these  
warnings could result in  
serious injury or death.**

GSI GROUP, INC. 217-226-4421 DC-GBC-1A

## DANGER

**HIGH VOLTAGE**

Will cause injury  
or death.

Lockout power  
before servicing.

DC-889

GSI Group Inc. 217-226-4421

### FUSE TABLE 1

#### TABLEAU DE FUSIBLE 1

F #	TYPE	AMP	F #	TYPE	AMP
FU1	_____	_____	FU8	_____	_____
FU2	_____	_____	FU9	_____	_____
FU3	_____	_____	FU10	_____	_____
FU4	_____	_____	FU11	_____	_____
FU5	_____	_____	FU12	_____	_____
FU6	_____	_____	FU13	_____	_____
FU7	_____	_____	FU14	_____	_____

DC-985

## WARNING AVERTISSEMENT

Line side of disconnect is energized.

La ligne de débranchement de côté est dynamisée.

Hazardous voltage can shock, burn or cause death.

Une tension dangereuse peut causer un choc, peut brûler ou peut causer la mort.

This unit may contain one or more voltages.

Cette unité peut contenir une ou plusieurs tensions.

DC-987

## WARNING AVERTISSEMENT

To maintain overcurrent short circuit and ground fault protection, the manufacturer’s instructions for selecting overload relays and setting the instantaneous trip circuit breaker must be followed.



Pour maintenir la protection de surcharge d’un court circuit ou de mise à la terre, les instructions du fabricant doivent être suivies en ce qui concerne la sélection des relais de surintensité et le positionnement du disjoncteur de déclenchement instantané.

DC-988



## Apply Safety Decals (Continued)

DC-989, DC-990, DC-991, DC-1061 and 420-1473-8

<p><b>WARNING</b> <b>AVERTISSEMENT</b></p> <p>Insure that the incoming AC power and all separate power sources are turned off and locked before working on this equipment. Failure to observe this practice may result in severe injury, death, and/or equipment damage. S'assurer que la puissance AC venant de l'extérieur et toutes autres sources de puissance indépendantes soient en arrêt et bloquées avant de travailler sur cet équipement. L'omission d'observer cette pratique peut résulter à des blessures sévères, la mort et/ou des dommages à l'équipement.</p> <p style="text-align: right;">DC-989</p>	<p><b>WARNING</b> <b>AVERTISSEMENT</b></p> <p>All maintenance procedures must be performed by qualified personnel who are familiar with the operation of this equipment. Failure to observe this warning can result in serious or even fatal injury and/or equipment damage. Toutes les procédures d'entretien doivent être exécutées par un personnel qualifié étant familier avec le fonctionnement de cet équipement. L'omission d'observer cet avertissement peut résulter à des blessures sérieuses et même mortelles. Peut aussi causer des dommages à l'équipement.</p> <p style="text-align: right;">DC-990</p>	<p><b>WARNING</b></p>  <p>Flame and pressure beyond door. May cause serious injury. Do not enter when dryer is running.</p> <p style="font-size: small;">GSI Group Inc. 217-226-4421 <span style="float: right;">DC-1061</span></p>
 <p style="text-align: right; font-size: small;">420-1473-8</p>		
<p>Be sure that charge light and all LED's are out before touching any componenets. Soyez assuré que la lumière de charge et toutes les LED soient fermés avant de toucher tout composants.</p> <p>All test equipment should be connected and disconnected with power off. Tout l'équipement de test devrait être branché et débranché quand tout est éteint.</p> <p>Grounded test equipment, such as oscilloscopes, may damage the inverter. L'équipement de test de mise à la terre, tel que les oscilloscopes, peut endommager l'onduleur de courant.</p> <p>Isolate all instruments from ground before using. The DC bus remains charged for several minutes after power is removed. Isoler tous les instruments au sol avant d'utiliser. Le DC bus reste chargé durant plusieurs minutes suivant la mise en arrêt de la puissance.</p> <p style="text-align: right;">DC-991</p>		

### 3. Safety Decals

## Apply Safety Decals (Continued)

DC-1063, DC-1064 and DC-1223

### CAUTION



**AIRBORNE PARTICLES  
DURING OPERATION.**

May impair vision and breathing.  
Do not enter when dryer is running.

GSI Group Inc. 217-226-4421

DC-1063

**Main Electrical Disconnect**  
Disconnects load side power.

DC-1223



### WARNING



**High speed belt drive  
operating overhead.**  
Can cause serious injury.  
Keep head and hands clear. Do not enter when dryer is running.

GSI Group 217-226-4421

DC-1064

GSI Group - Flora, IL 62839  
**Tower Dryer**

Model 7 5046  
Serial twr000270  
Fuel NATURAL GAS

Supply Voltage 3 Phase 460 Volts 60 HZ  
Max. Amps 371 Short Circuit 5

**FLAME CONTROL PANEL**

	Size Fans	HP	AMP
	3	100	113

	HP	AMP	HP	AMP
Metering	2	3.4	Wet Top	
Wet ConvA			Dry Conv	10 14
Wet ConvB	10	14	Dry Aux	
Wet Aux			Dry Leg	
Wet Leg			Dry Top	

Ref. Dwg. : XX-01 thru XX17

## Safety Decal # DC-GBC-1A

### Location of Decal

English and spanish decals are placed on inside of hatch door prior to shipping.

		
 <p>Rotating flighting could kill or dismember.</p>	 <p>Flowing material could trap and suffocate.</p>	 <p>Crusted material could collapse and suffocate.</p>
<p><b>Keep clear of all augers. DO NOT ENTER this bin!</b></p>		
<p>If you must enter the bin:</p> <ol style="list-style-type: none"> <li>1. Shut off and lock out all power.</li> <li>2. Use a safety harness and safety line.</li> <li>3. Station another person outside the bin.</li> <li>4. Avoid the center of the bin.</li> <li>5. Wear proper breathing equipment or respirator.</li> </ol>		
<p><b>Failure to heed these warnings could result in serious injury or death.</b></p>		
<p><small>GSI GROUP, INC. 217-226-4421</small> <span style="float: right;"><small>DC-GBC-1A</small></span></p>		



Inside view - Hatch door installed with decals in place.



Hatch door with decals in place.

### 3. Safety Decals

## Safety Decal # DC-889

### Location of Decal

On outside of main power panel, on right door to the left of main disconnect OFF position.

 <p>GSI Group Inc. 217-226-4421</p>	<p><b>⚠ DANGER</b></p> <p><b>HIGH VOLTAGE</b> Will cause injury or death. Lockout power before servicing.</p> <p>DC-889</p>	
<p>Example - Standard completed installations included with tower dryers.</p>		

# Safety Decals # DC-985, DC-987 and DC-988

## Location of Decal

Inside main power box door, on same side as main electrical disconnect.

**WARNING**  
**AVERTISSEMENT**

To maintain overcurrent short circuit and ground fault protection, the manufacturer's instructions for selecting overload relays and setting the instantaneous trip circuit breaker must be followed.

Pour maintenir la protection de surcharge d'un court circuit ou de mise à la terre, les instructions du fabricant doivent être suivies en ce qui concerne la sélection des relais de surintensité et le positionnement du disjoncteur de déclenchement instantané.

**DC-988**

**WARNING**  
**AVERTISSEMENT**

Line side of disconnect is energized.

La ligne de débranchement de côté est dynamisée.

Hazardous voltage can shock, burn or cause death.

Une tension dangereuse peut causer un choc, peut brûler ou peut causer la mort.

This unit may contain one or more voltages.

Cette unité peut contenir une ou plusieurs tensions.

**DC-987**

NEMA 4 RATED ENCLOSURE  
 USE NEMA 4, 4X, OR  
 EQUIVALENT FITTINGS ONLY

SN 9798

Complies With:  
 UL 508A  
 CSA C22.2 No. 14  
 Essential Industrial  
 Control Panel  
 Listing #E1210074

CAUTION

Be sure that charge light and all LED's are out before touching any components.  
All test equipment should be connected and disconnected with power off.  
Grounded test equipment, such as oscilloscopes, may damage the inverter.  
Isolate all instruments from ground before using. The DC bus remains charged for several minutes after power is removed.

DC-991

WARNING

Insure that the incoming AC power and all separate power sources are turned off and locked before working on this equipment. Failure to observe this practice may result in severe injury, death, and/or equipment damage.

DC-989

WARNING

To maintain overcurrent short circuit and ground fault protection, the manufacturer's instructions for selecting overload relays and setting the instantaneous trip circuit breaker must be followed.

DC-988

WARNING

All maintenance procedures must be performed by qualified personnel who are familiar with the operation of this equipment. Failure to observe this warning can result in serious or even fatal injury and/or equipment damage.

DC-990

WARNING

Line side of disconnect is energized.  
Hazardous voltage can shock, burn or cause death.  
This unit may contain one or more voltages.

DC-987

WARNING

If an overload or a fault current interruption occurs, circuits must be checked to determine the cause of the interruption. If a fault condition exists, the current-carrying components should be examined and replaced if damaged, and the integral current sensors must be replaced to reduce the risk of fire or electric shock.

DC-2017

FUSE TABLE 1

F#	TYPE	AMP	F#	TYPE	AMP
FU1	ATDR	6	FU8	_____	_____
FU2	ATDR	6	FU9	_____	_____
FU3	ATDR	6	FU10	_____	_____
FU4	_____	_____	FU11	_____	_____
FU5	_____	_____	FU12	_____	_____
FU6	_____	_____	FU13	_____	_____
FU7	_____	_____	FU14	_____	_____

DC-985

FUSE TABLE 1

TABLEAU DE FUSIBLE 1

F #	TYPE	AMP	F #	TYPE	AMP
FU1	_____	_____	FU8	_____	_____
FU2	_____	_____	FU9	_____	_____
FU3	_____	_____	FU10	_____	_____
FU4	_____	_____	FU11	_____	_____
FU5	_____	_____	FU12	_____	_____
FU6	_____	_____	FU13	_____	_____
FU7	_____	_____	FU14	_____	_____

DC-985

### 3. Safety Decals

## Safety Decals # DC-989, DC-990 and DC-991

### Location of Decal

Inside main power box door, on same side as main electrical disconnect.

**WARNING  
AVERTISSEMENT**

Insure that the incoming AC power and all separate power sources are turned off and locked before working on this equipment. Failure to observe this practice may result in severe injury, death, and/or equipment damage.

S'assurer que la puissance AC venant de l'extérieur et toutes autres sources de puissance indépendantes soient en arrêt et bloquées avant de travailler sur cet équipement. L'omission d'observer cette pratique peut résulter à des blessures sévères, la mort et/ou des dommages à l'équipement.

**DC-989**

**WARNING  
AVERTISSEMENT**

All maintenance procedures must be performed by qualified personnel who are familiar with the operation of this equipment. Failure to observe this warning can result in serious or even fatal injury and/or equipment damage.

Toutes les procédures d'entretien doivent être exécutées par un personnel qualifié étant familier avec le fonctionnement de cet équipement. L'omission d'observer cet avertissement peut résulter à des blessures sérieuses et même mortelles. Peut aussi causer des dommages à l'équipement.

**DC-990**

Be sure that charge light and all LED's are out before touching any componenets.

Soyez assuré que la lumière de charge et toutes les LED soient fermés avant de toucher tout composants.

All test equipment should be connected and disconnected with power off.

Tout l'équipement de test devrait être branché et débranché quand tout est éteint.

Grounded test equipment, such as oscilloscopes, may damage the inverter.

L'équipement de test de mise à la terre, tel que les oscilloscopes, peut endommager l'onduleur de courant.

Isolate all instruments from ground before using. The DC bus remains charged for several minutes after power is removed.

Isoler tous les instruments au sol avant d'utiliser. Le DC bus reste chargé durant plusieurs minutes suivant la mise en arrêt de la puissance.

**DC-991**

## Safety Decals # DC-1061, DC-1063 and 420-1473-8

### Location of Decal

All heat access entry ways and/or doors must be labeled with this sticker.



 <b>CAUTION</b>

<p><b>AIRBORNE PARTICLES DURING OPERATION.</b></p> <p>May impair vision and breathing.</p> <p>Do not enter when dryer is running.</p>
<p>GSI Group Inc. 217-226-4421 <span style="float: right;">DC-1063</span></p>

 <b>WARNING</b>

<p>Flame and pressure beyond door.</p> <p>May cause serious injury.</p> <p>Do not enter when dryer is running.</p>
<p>GSI Group Inc. 217-226-4421 <span style="float: right;">DC-1061</span></p>

	
	<p><b>CONFINED SPACE</b></p>
<p><b>AUTHORIZED PERSONNEL ONLY</b></p>	
<p>420-1473-8</p>	

### 3. Safety Decals

## Safety Decals # DC-1063 and DC-1064

### Location of Decal

On outside of louvered access door to cooling section.



**CAUTION**

**AIRBORNE PARTICLES DURING OPERATION.**  
May impair vision and breathing.  
Do not enter when dryer is running.

GSI Group Inc. 217-226-4421 DC-1063

**WARNING**

**High speed belt drive operating overhead. Can cause serious injury. Keep head and hands clear. Do not enter when dryer is running.**

GSI Group 217-226-4421 DC-1064

**DANGER**

**CONFINED SPACE**

**AUTHORIZED PERSONNEL ONLY**

420-1473-8

**DANGER**

**HIGH VOLTAGE**  
Will cause injury or death.  
Lockout power before servicing.

GSI Group Inc. 217-226-4421 DC-889



## Safety Decals # DC-1223 and DC-1317

### Location of Decal

1. On outside of main power box door, to left of main electrical disconnect.
2. On outside of main power box door, above emergency stop disconnect.

### Main Electrical Disconnect

Disconnects load side power.

DC-1223



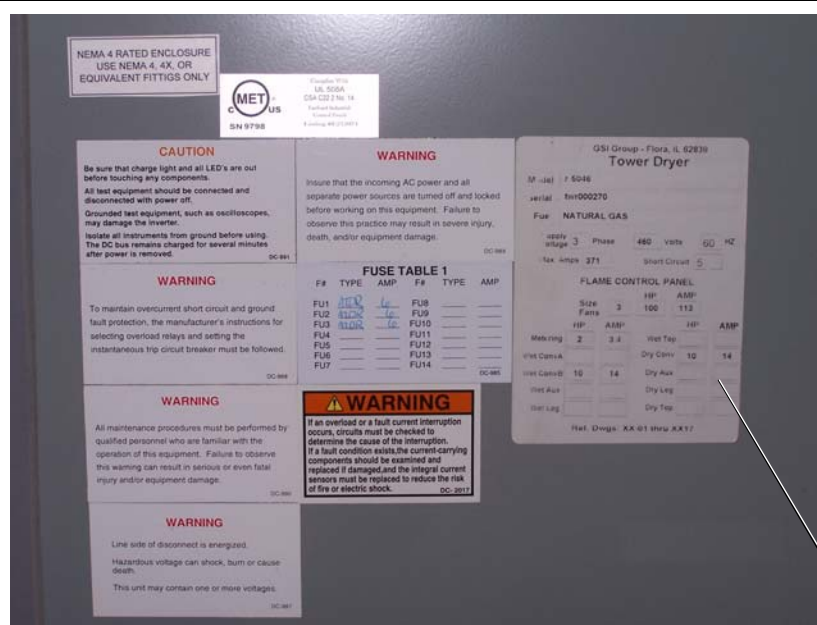
### 3. Safety Decals

## Information Decals

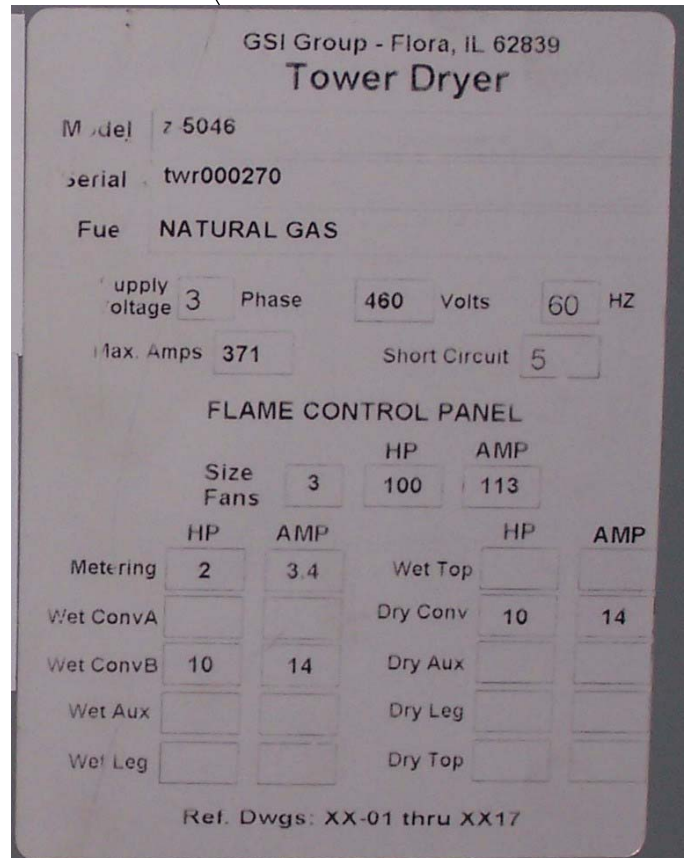
### Nameplate for Main Power Box

### Location of Decal

Inside main power box door, on same side as main electrical disconnect.



Example - Information decal





**Important Safety Precaution:**  
**All electrical installations must be made by qualified personnel.**

See appendices [on Pages 113-125](#) for wiring notes and electrical drawings, etc. ([See Pages 120 and 121.](#))

## Installation Summary

**NOTE:** *Below is a general overview on how to complete field wiring. The installation procedures may vary due to site location and position of the dryer.*

1. This installation summary applies to GSI Tower Grain Dryers of any diameter, voltage or number of fans.
2. The dryer has a **PLC based control system** that consists of a main **power box** and a **control box**.

The **power box** contains all of the power components necessary to operate the dryer. This power box is a free standing NEMA 4 enclosure of varying sizes, based upon the size of the dryer. The power box is generally anchored on the outer edge of the dryer foundation beneath one of the windows on the dryer. All of the conduit runs will come out of the lower back of the power box. The conduits either run up the exterior of the dryer, into the dryer or to the fuel train.

The **control box** contains the computerized controller (**electronic monitoring control system**), operator's controls, switches, etc. The control box can be installed at the base of the dryer with provided mounting equipment or remote mounted. Note, remote mounting control box will require additional materials based upon mounting distance from the dryer.

3. The **fuel train** (with **maxon gas valves**, **modutrol motor**, **pilot fuel train** and **pilot solenoid**) is anchored to the foundation beneath the dryer or secured to dryer legs.
4. Other installations are made during dryer construction as noted.

\* See all "Electrical Installations manual PNEG-708" sections of this manual for additional installation instructions. All work needs to meet the GSI GROUP specifications and meet all NATIONAL ELECTRICAL CODES.

After the tower grain dryer is erected, wire the dryer electrical components to the **power box** as follows. ([See Pages 120 and 121.](#))

5. **Fan motors** (Use 1, 3 or 4 runs of conduit. Size of conduit depends on dryer size and voltage.) ([See Appendix B Fan Motor Wiring Guide on Page 119.](#))

During dryer construction, the fan motors are hung in the walk-in cooling section of the dryer.

Run a conduit for each fan motor from back of power box, up side of dryer (parallel with other conduits) to the motor window. Turn each conduit into the dryer (parallel with other conduits) and run to its fan motor. (Use flexible conduit at the fan motors so the motor mount can be moved back and forth when tightening the fan belts.) The motor conduit needs to be installed so the motor can be removed or serviced.

Wire each fan motor from its fan (blower) motor starter in the power box. TIP; Turning the 'head' of the motor is an option.

## 4. Overview and Planning

### Installation Summary (Continued)

#### 6. Air switch tubing (one for each fan)

(Use 3/8" copper tubing - same tubing used for pilot fuel line.)

Air switches are installed in the power box at the factory.

Brass connectors for the air switch tubing are installed on the side of the power box at the factory prior to shipping. (The brass connections are installed on the side opposite the control box.)

Air switches are numbered for ease of installation. Run air switch tubing for each fan from its brass connector on the outside of the power box to the fan. Wire tie the air switch tubing to the fan motor conduit as it runs up through motor window to the fan. Extend the air switch tubing up inside fan no more than 1" to 2" past top of venturi. Air switch tubes must connect to the same number on the motor starter.



Figure 4A

**NOTE:** Thread sealant is required at all threaded connections.

#### 7. Metering unload device (Use 1/2" conduit)

During dryer construction, metering unload device is installed below walk-in cooling section of dryer, down the discharge hopper area.

Run conduit from back of power box, up side of dryer (parallel with other conduits) to dryer window. Turn conduit into dryer motor window, run down through walk-in cooling section floor. (Keep conduit as close to side of dryer as possible.) Clamp conduit along inner hopper and run to metering unload device.

Wire metering unload device wires to inverter drive in power box at U, V and W terminal points.

#### 8. Interior high-limits (overheat) (with copper capillaries), adjustable plenum high-limit thermostat (overheat), plenum temperature sensor (RTD)\* (Wire all three (3) in one 1/2" conduit.)

Run conduit from back of power box, up side of dryer (parallel with other conduits) to dryer window (usually the motor window). Turn conduit into dryer, run up above motor window. Install interior high-limits and adjustable plenum high-limit thermostat just above motor window. (Inside walk-in cooling section of dryer.)

Extend the conduit from the adjustable plenum high-limit thermostat up through divider hopper to approximately 3' above heating section walkway. Install black probe sensor on top of the conduit. Pull copper capillaries from adjustable plenum high-limit thermostat (in walk-in cooling section below), roll capillaries up, attach to the dryer with insulated clamp and ties and install copper capillaries on dryer wall (parallel to heating section walkway).

Wire from terminal strip in power box to each electrical component in walk-in heating or cooling sections of dryer. (Connect the plenum temperature sensor in the power box to terminals.

Run shielded cable (two (2) wire) from sensor PC. Connect red to red and white to white.

*(See Pages 120 and 121.)*

*See Appendix C Field Notes on Pages 120 and 121 and "wiring diagrams manual".*

## Installation Summary (Continued)

### 9. Exterior high-limits (overheats) (Wire all three (3) high-limits in one 1/2" conduit.)

During dryer construction, upper high-limit, middle high-limit, lower high-limit and their respective copper capillaries are installed on the exterior of the dryer.

During dryer construction, one conduit for all three (3) exterior high-limits is installed behind or directly to the left or right of the ladder and down to approximately 10' above foundation.

Run conduit from back of power box (up parallel with other conduits), around dryer to the ladder and then up side of dryer to connect with existing conduit.

Wire from the terminal strip in power box to each exterior high-limit. (*See Pages 120 and 121.*)

*See Appendix C Field Notes on Pages 120 and 121* and "wiring diagrams manual".

\* Resistance temperature device.

### 10. Bindicator(s)

Use one 1/2" conduit - also contains grain temperature sensors wiring. Even if the dryer only requires one bindicator, pull wires for two (2) bindicators. This will allow for the addition of a second bindicator if required.

During dryer construction, bindicator(s) are installed on the exterior of the dryer, within reach of the ladder. The standard bindicator is installed on the side of the dryer, within reach of ladder, approximately 15" to 20" below the dryer roof eave. The optional bindicator is installed on the dryer roof, one sheet to left of the hatch, approximately 40" to 48" above roof eave depending on safety wind ring positioning.

During dryer construction, one conduit for the bindicator(s) and grain temperature sensor is installed down to approximately 10' above the foundation.

Run conduit from back of power box (up parallel with other conduits), around dryer to ladder and then up the side of the dryer to connect with existing conduit. Install tee to conduit for grain temperature sensors approximately 12" below bottom grain temperature sensors.

Pull bindicator wires and grain temperature shielded cables at the same time from terminal strip in power box to bindicator(s).

*See Appendix C Field Notes on Pages 120 and 121* and "wiring diagrams manual".

### 11. Grain temperature sensors (RTDs) Use one 1/2" conduit - also contains wiring for bindicators.

Run conduit from back of power box (up parallel with other conduits), around dryer to ladder and then up side of dryer to connect with existing 1/2" bindicator conduit.

Pull shielded cable (when bindicator wires are pulled), from terminal points MC8, MC7 and MC6 on terminal strip in power box to grain temperature sensors.

*See Appendix C Field Notes on Pages 120 and 121* and "wiring diagrams manual".

## 4. Overview and Planning

### Installation Summary (Continued)

#### 12. Ignitor - ignition, spark plug

Use 1/2" conduit - **MUST RUN SEPARATE FROM AND PARALLEL TO FLAME SENSOR CONDUIT.** Ignitor and flame sensor conduits run parallel from power box to burner.

During dryer construction, the burner with installation point for the ignitor is installed in the walk-in heating section.

Run conduit parallel with flame sensor conduit and other conduits up the side of dryer to the dryer window. Turn up and run through divider hopper. Turn and run through burner housing, then extend conduit approximately 4" beyond burner housing. **NOTE:** *Conduit must run within 16" of ignitor to protect ignition cable.* Install 1/2" liquid-tight cable connector to conduit. Install ignitor to burner. Wires must be pulled snug and tied up so they cannot blow upon the burner. Conduit must be installed below the burner manifold.

Pull ignition cable from ignition transformer in power box to ignitor in burner.

#### 13. Flame sensor - flame probe, flame rod

Use 1/2" conduit - **MUST RUN SEPARATE FROM AND PARALLEL TO IGNITOR CONDUIT.** Flame sensor and ignitor conduits run parallel from power box to burner.

During dryer construction, the burner with installation point for the flame sensor is installed in the walk-in heating section.

Run conduit parallel with ignitor conduit and other conduits up side of dryer to dryer window. Turn conduit up and run through divider hopper. Turn and run through burner housing, then extend conduit approximately 4" beyond burner housing. Install 1/2" liquid-tight cable connector to conduit. Install flame sensor to burner.

Pull wires (14 gauge) from protectofier (terminal E) in power box to flame sensor in burner. Wire must be pulled snug and tied down tight. Wires must be installed below the burner manifold and conduit.

#### 14. Fuel train

**Pilot fuel line** - Use 3/8" copper tubing - same tubing used for air switches.

**Fuel train wiring** - Use one 1/2" conduit to wire pilot solenoid, maxon gas valves and modutrol motor.

During dryer construction, the fuel train is anchored to the foundation under the dryer or secured to the dryer legs, includes pilot fuel train assembly, pilot solenoid, maxon gas valves and modutrol motor.

**Pilot fuel line:** Connect 3/8" copper pilot fuel line from pilot fuel train assembly on fuel train to connecting point on burner. Wire tie 3/8" copper pilot fuel line to fuel piping. Fuel piping runs from fuel train up exterior of dryer, through motor window into walk-in cooling section and up along fuel line to burner.

**Fuel train:** Run conduit up dryer leg closest to power box, around dryer parallel with other conduits, down dryer leg closest to fuel train using flexible conduit and then over to the fuel train.

Wire from respective points on terminal strip in power box to pilot solenoid, maxon gas valves and modutrol motor on fuel train.

*See Appendix C Field Notes on Pages 120 and 121 and "wiring diagrams manual".*

## Installation Summary (Continued)

15. **Work light and safety package** - Use one 1/2" conduit.

Locate and install according to dryer owner preference.

The work light and safety package usually are installed on dryer, just above power box.

See [Appendix C Field Notes on Pages 120 and 121](#) and “wiring diagrams manual”.

## Planning Electrical Control System Examples

The **electrical control system** consists of **power box** in NEMA 4 cabinet and **control box** with **electronic monitoring control system**. (See [Figure 4B](#).)

**NOTE:** Power box is shipped pre-assembled. (See [Figure 4C on Page 32](#).)

**NOTE:** Control box or display box with PLC control system is provided with all necessary hardware for a typical mounting at base of dryer. (See [Figure 4D on Page 32](#).)



Figure 4B

Planning Electrical Control System Examples (Continued)



Figure 4C Interior of Power Box



Figure 4E Close Up - Air switches (for 3 fan dryer) as shipped.



Figure 4D Interior of control box with electronic monitoring control system.



Figure 4F Close Up - Blower motor starters (for 4 fan dryer) as shipped.



## Planning Electrical Control System Examples (Continued)

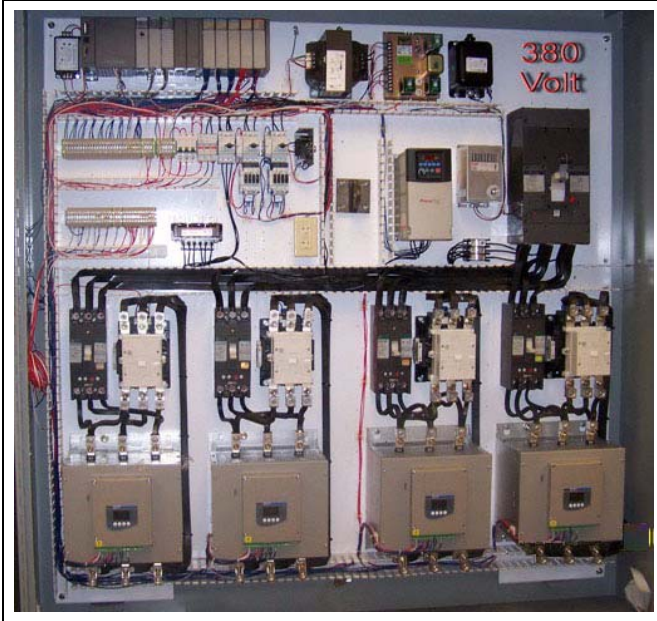


Figure 4G

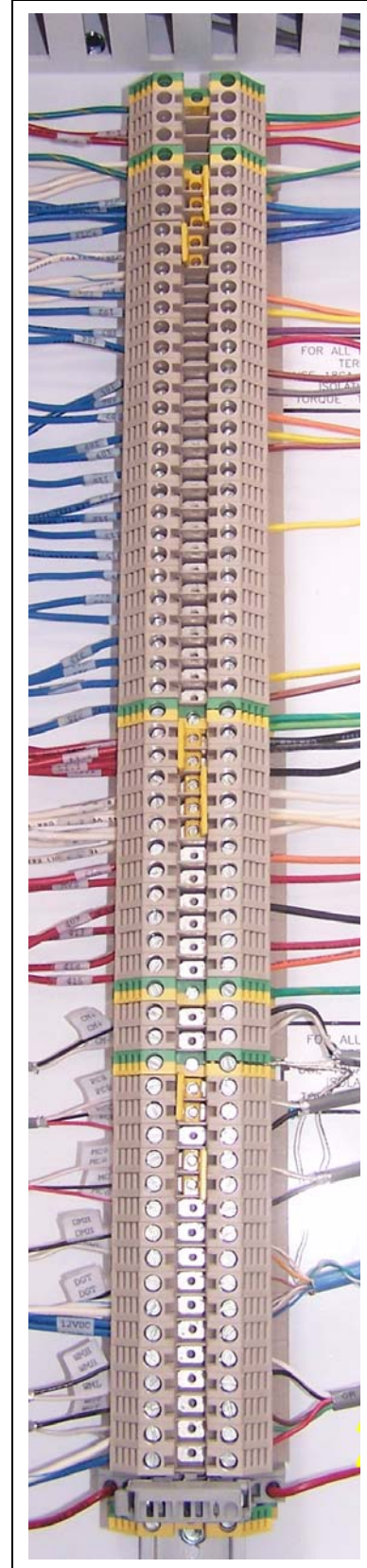


Figure 4H Close Up - Terminal strip, etc., as shipped.

## 4. Overview and Planning

### Planning Electrical Control System Examples (Continued)

The location of the electrical control system is determined by the tower dryer owner or by someone designated by the tower dryer owner, such as the elevator manager.

#### Tools and materials

Four (4) 1/2" x 5-1/2" heavy duty expanding anchor bolts with four (4) washers and four (4) nuts.

Drill and 1/2" masonry bit 3/4" wrench.

Forklift or tractor to place the power box under a dryer window.



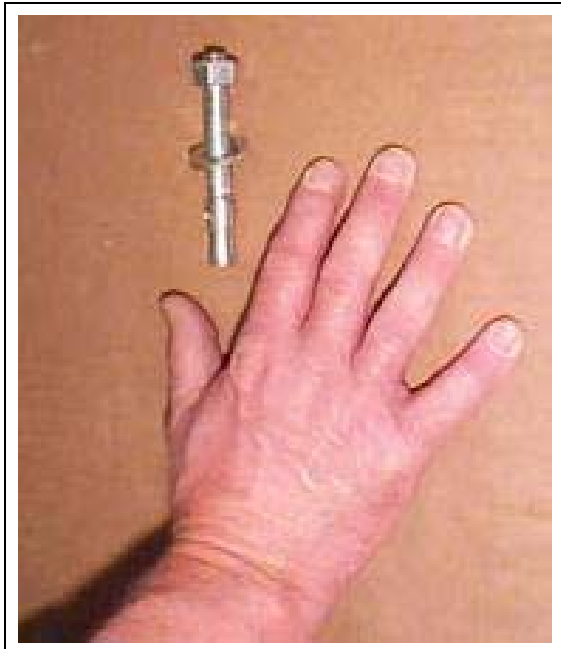
**Lift the power box using eyelets on top of box - box may tip if lifted from below.**

### Steps to Anchor Power Box on Foundation

1. Determine location for electrical control system.
2. Center power box under dryer window.
3. Measure, mark and drill four (4) holes in concrete of tower dryer foundation.
4. Bolt power box legs into concrete with heavy duty expanding anchor bolts.

**NOTE:** PLC monitoring control display systems panel comes separately packaged. Operators panel package does include mounting rails, mounting backer panel, hood and all hardware needed. All interconnects are done during the field wiring process.

**NOTE:** Elevator electrician will wire electrical supply feed.



**Figure 4I** Heavy Duty Expanding Anchor Bolt



**Figure 4J** Heavy duty expanding anchor bolts (red heads) anchor power box to dryer foundation.

## Planning Electrical Control System Examples (Continued)

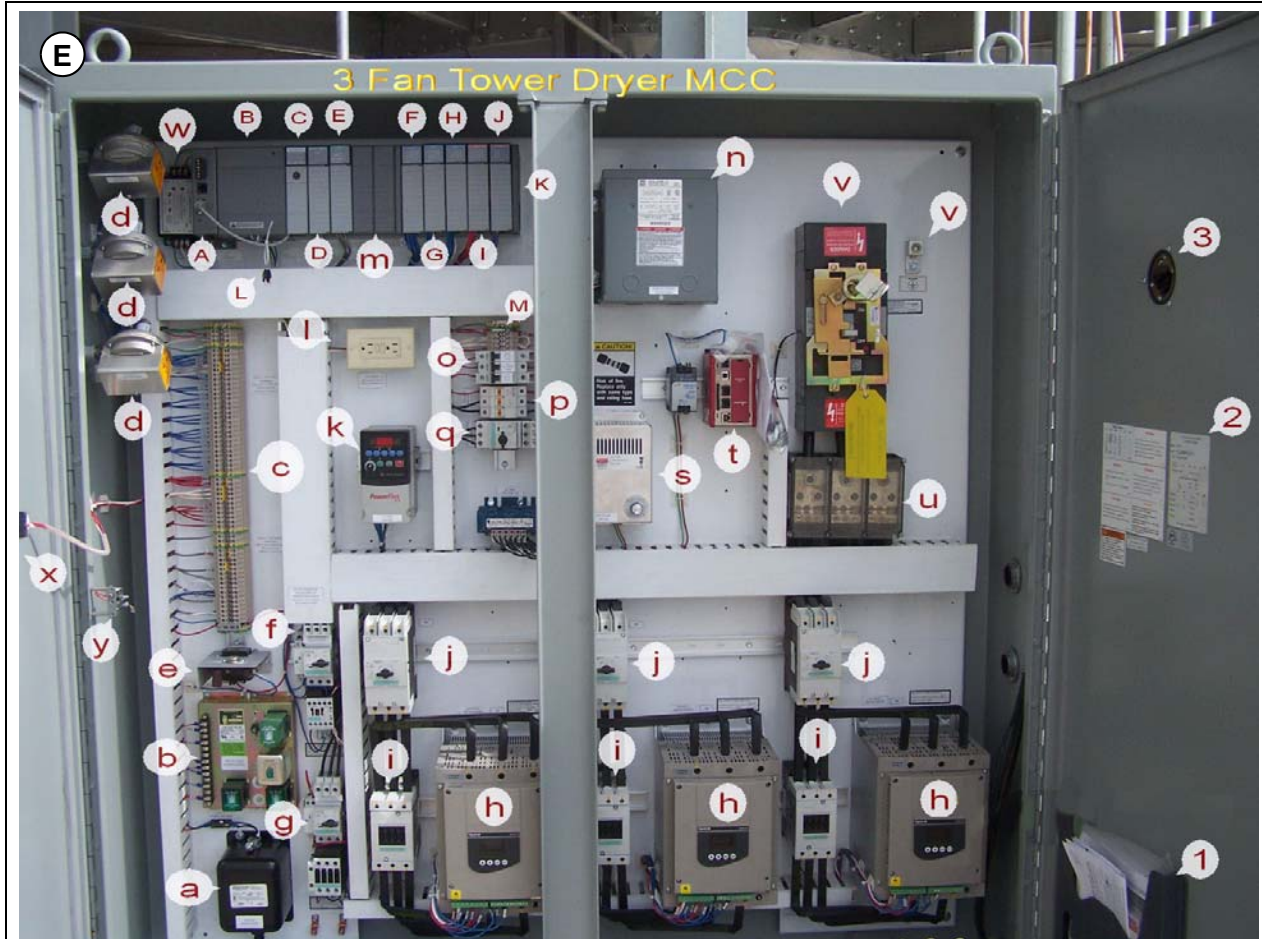


**Figure 4K** Control box with electronic monitoring control system installed.



**Figure 4L** Power Box Installed (3 Fan Dryer).

Planning Electrical Control System Examples (Continued)



- |                                     |                             |
|-------------------------------------|-----------------------------|
| A. Ignition transformer             | 1. Dryer manual compartment |
| B. Protector burner control         | 2. Dryer informations       |
| C. Terminal strip                   | 3. Main disconnect assembly |
| D. Air pressure switches            |                             |
| E. 15V MC power supply              |                             |
| F. Dry conveyor starter/contactor   |                             |
| G. Wet conveyor starter/contactor   |                             |
| H. Fan/blower soft starts           |                             |
| I. Fan/blower contactors            |                             |
| J. Fan/blower starter-breaker       |                             |
| K. Toshiba inverter                 |                             |
| L. 120V 6 Amp receptical            |                             |
| M. Main PLC components              |                             |
| N. Control voltage transformer      |                             |
| O. Control power breakers           |                             |
| P. Control power fuses block        |                             |
| Q. Unload motor starter             |                             |
| R. In-line reactor                  |                             |
| S. Block heater                     |                             |
| T. WatchDog and power supply system |                             |
| U. Main power distribution block    |                             |
| V. Main disconnect/ground lug       |                             |
| W. In-line filter                   |                             |
| X. Main panel emergency stop        |                             |
| Y. Door safety switch               |                             |

Figure 4M Interior of Power Box Wired

## Planning Electrical Control System Examples (Continued)

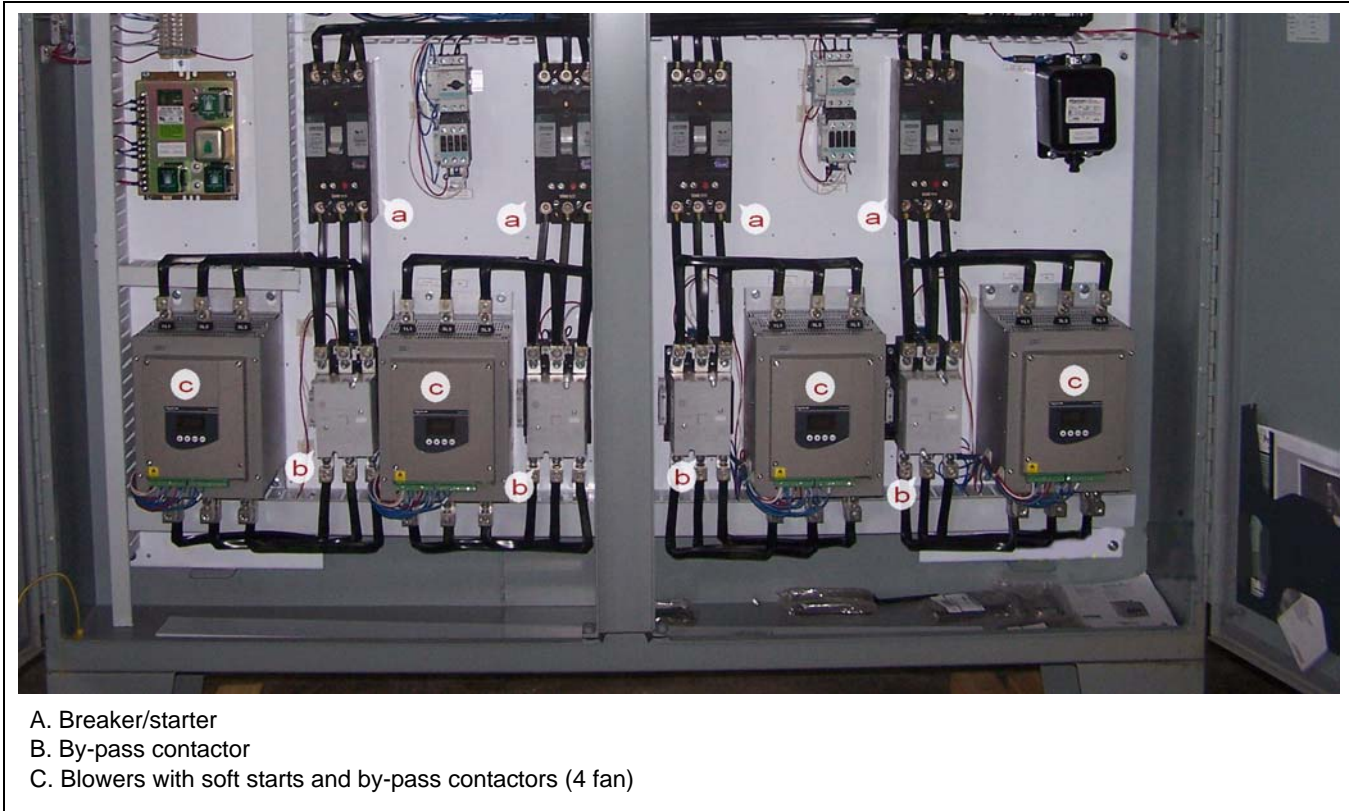


Figure 4N Close Up - Power Box Wired

## Planning Conduit Examples (10' Lengths, Diameter 1/2", 1" and 2-1/2")

### Guidelines

1. If power box is to be located under dryer, place it so that there is enough room for all conduits to exit the back of the power box and run directly up to the dryer window, which is usually the motor window.
2. Fan motor conduits are usually run through the center of the motor window, with all 1/2" conduits placed to either side as space permits. There are a minimum standard of ten (10) 1/2" conduits required. *(See List on Page 39.)*
3. Run conduit parallel or perpendicular to other conduits.
4. Vertical conduit runs should be plumb, neat, sealed and tight.
5. Note orientation of electrical components both inside and outside of dryer with respect to direction of conduit leaving power box.
6. Support conduit systems with superstrut channels. Install Z-bracket where conduits enter motor window and behind parallel conduits to keep them in line.
7. Electrical boxes should be readily accessible.
8. **All electrical '4 way gang' style box connections completed in the field wiring process must be installed to be completely and safely accessible.**
9. Use heavy duty thread sealing compound on conduit connections to tighten seals and prevent leaks.
10. Dryers must be wired to NECA standards and surpass local codes.

Planning Conduit Examples (10' Lengths, Diameter 1/2", 1" and 2-1/2") (Continued)

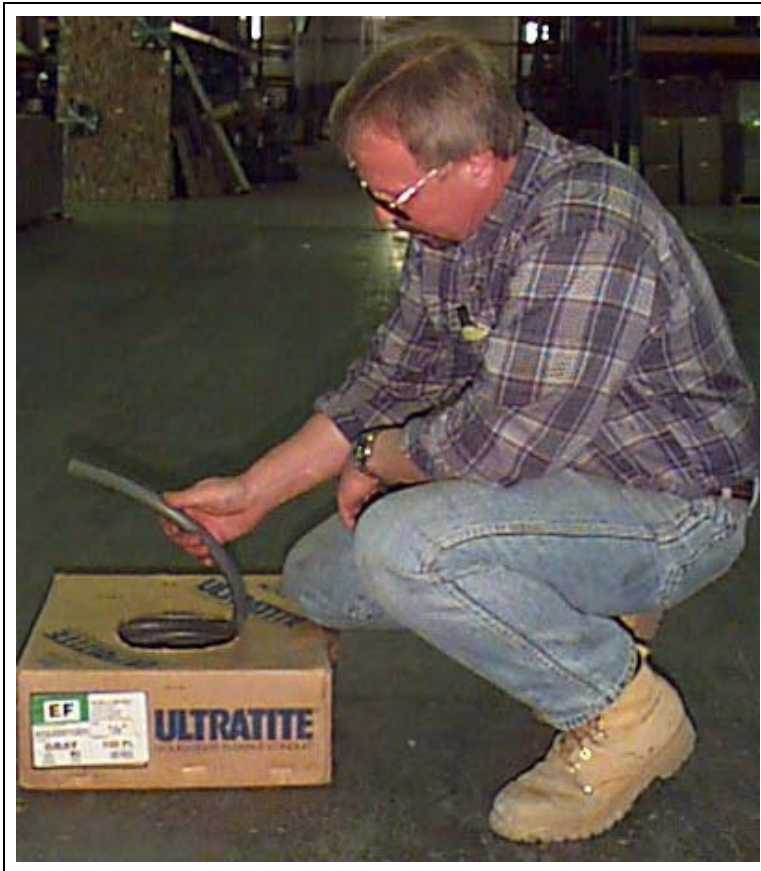


Figure 4O Flexible Conduit

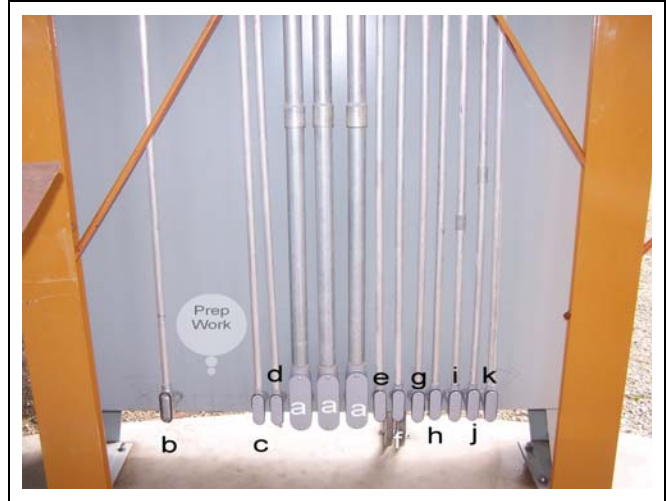


Figure 4P IMC Rigid, Threaded Conduit

## Planning Conduit Examples (10' Lengths, Diameter 1/2", 1" and 2-1/2") (Continued)



**Figure 4Q** Front View - Conduit installed on 4 fan dryer.



**Figure 4R** Rear View - Conduit installed on 3 fan dryer.

### There are Ten (10) 1/2" Conduits on all Dryers - Three (3) External and Five (5) Internal

Exterior conduits to top of dryer:

1. Exterior upper, middle and bottom high-limits receives 1. (See "H" in Figure 4R.)
2. Upper and lower bindicator and GT RTD receives 1. (See "J" in Figure 4R.)
3. Wet moisture sensor when applicable receives 1. (See "I" in Figure 4R.)

Other exterior conduits:

1. Operators panel receives 1 (two (2) preferred). (See "K" in Figure 4R.)
2. Gas and pilot fuel train receives 1. (See "B" in Figure 4R.)
3. Work light, alarm light and horn receives 1. (See "G" in Figure 4R.)
4. Dry moisture sensor when applicable receives 1. (See "I" in Figure 4R.)
5. One conduit to fuel train electrical components.

Interior conduits are normally 4-1/2" conduits and applicable fan/blower motor conduits:

1. Flame sense conduit. (See "E" in Figure 4R.)
2. Spark wire conduit. (See "F" in Figure 4R.)
3. Unload metering device. (See "D" in Figure 4R.)
4. Inside high-limit, adjustable plenum high-limit and plenum temperature RTD. (See "C" in Figure 4R.)
5. Fan/blower motor conduits range from 1 to 4. (See "A" in Figure 4R.)

Planning Conduit Examples (10' Lengths, Diameter 1/2", 1" and 2-1/2") (Continued)



Figure 4S Rear View - Lights and horn installed on 3 fan dryer.



1. Bindicator and grain temperature RTD conduit.
2. Wet/dry moisture sensor conduit.
3. Outside high-limit thermal sensor conduit

Figure 4T Side View - Conduit installed on all dryers with the tri-point moisture sensor option.



## Planning Knock Outs Examples

### Guidelines

1. All of the dryer's electrical wiring exits the lower back of the power box through knock outs.
2. Plan ahead for the correct number, size and spacing of knock outs.
3. Space knock outs as close together as possible and run conduits straight up dryer. **NOTE:** *Avoid bending conduits whenever possible.*
4. Carefully mark and drill knock outs.
5. In power box, install weather-tight myers hubs to each conduit hole to protect wires.



**Figure 4U** Hydraulic punch driver set with 1/2" to 2" knock out punches.



**Figure 4V** Interior View of Power Box - With myers hubs installed to knock outs.

### Planning Knock Outs Examples (Continued)



Figure 4W



Figure 4Y

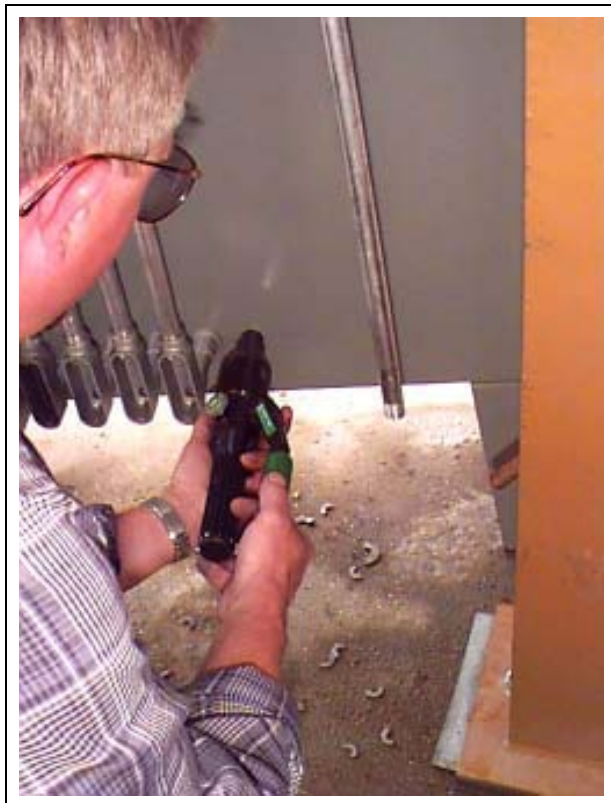


Figure 4X



Figure 4Z

### Planning Knock Outs Examples (Continued)

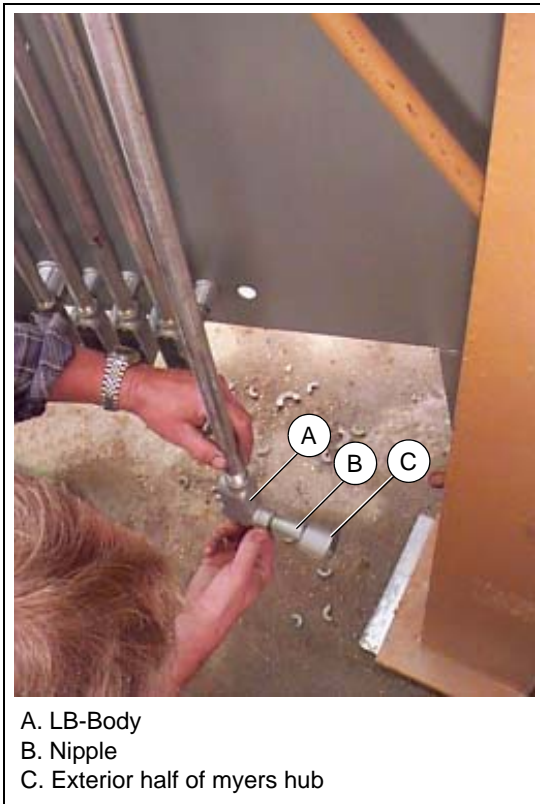


Figure 4AA



D. Interior half of myers hub

Figure 4AC



A. LB-Body  
B. Nipple  
C. Exterior half of myers hub

Figure 4AB

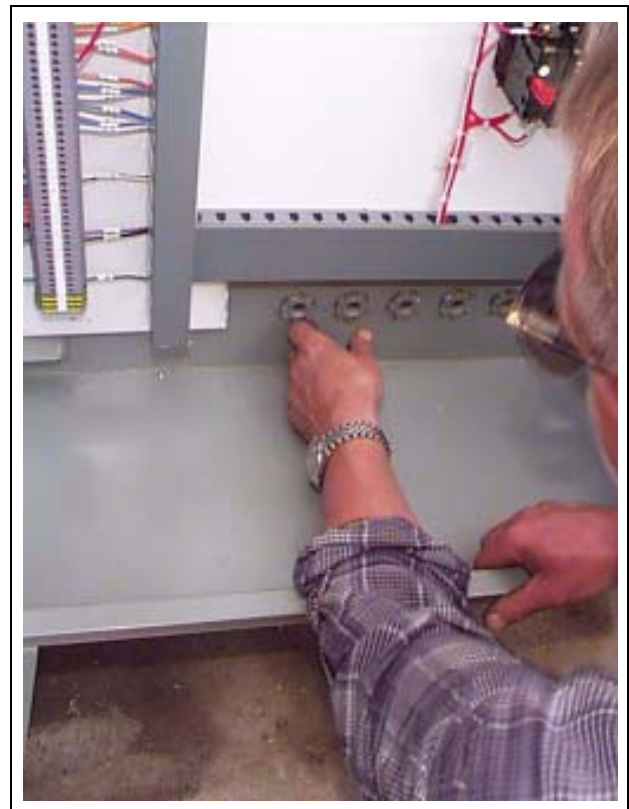


Figure 4AD

**NOTE:** Verify all these connections to panel are located correctly and sealed tight.

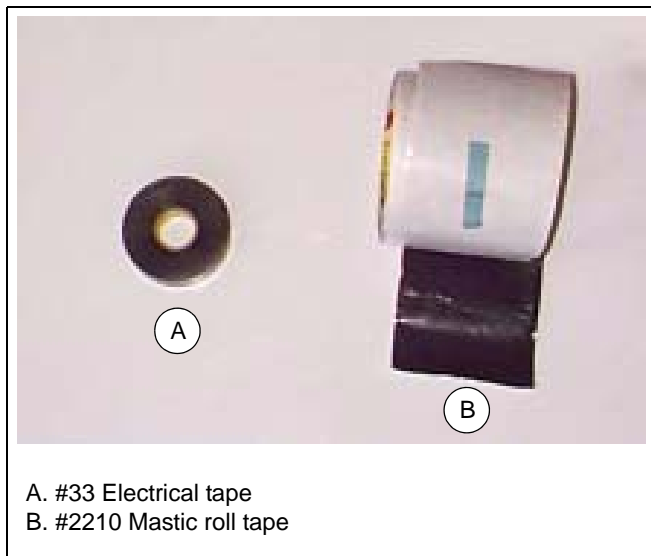
### Planning Wiring Examples

#### Guidelines

1. Run wires within wireways inside the power box.
2. Wires that cross wireways should run underneath raceways, especially high-voltage wires such as the ignition cable.



**No wires should run over the top of any wireway.**



**Figure 4AE**



**Figure 4AF Wire Rack**



**Figure 4AG Wire #1 THW Black**

## Planning Wiring Examples (Continued)



**Figure 4AH** *Pairing off wires for pilot fuel train.*



**Figure 4AI** *Close Up - Pulling wires from rear of power box.*

## Planning Wiring Examples (Continued)



**Figure 4AJ** *Tying wire to fish tape prior to pulling it through conduit.*



**Figure 4AK** *Pulling wires to exterior high-limits.*



**Important Safety Precaution:**  
All electrical installations must be made by qualified personnel.

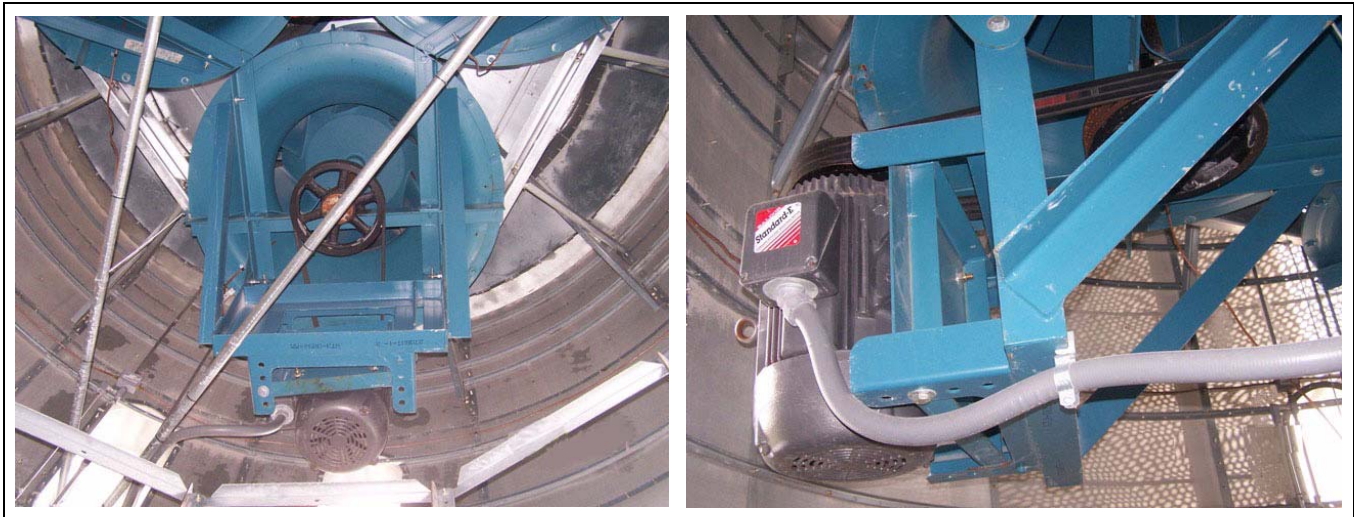
See appendices [on Pages 113-125](#) for wiring notes and schematics, etc. (See [Pages 120 and 121.](#))

## Fan Motors Wiring and Installing Air Switch Tubing

1, 3 or 4 Fan motors are installed during construction based upon dryer size.



**Figure 5A** Example: 100 HP, 230V/460V Fan Motor



**Figure 5B** Example: Wiring for 3 fan motors installed. Note 3/8" copper tubing for each air switch is wire tied to fan motor conduit. **NOTE:** Fan cover is not yet installed.

## 5. Fan Motors

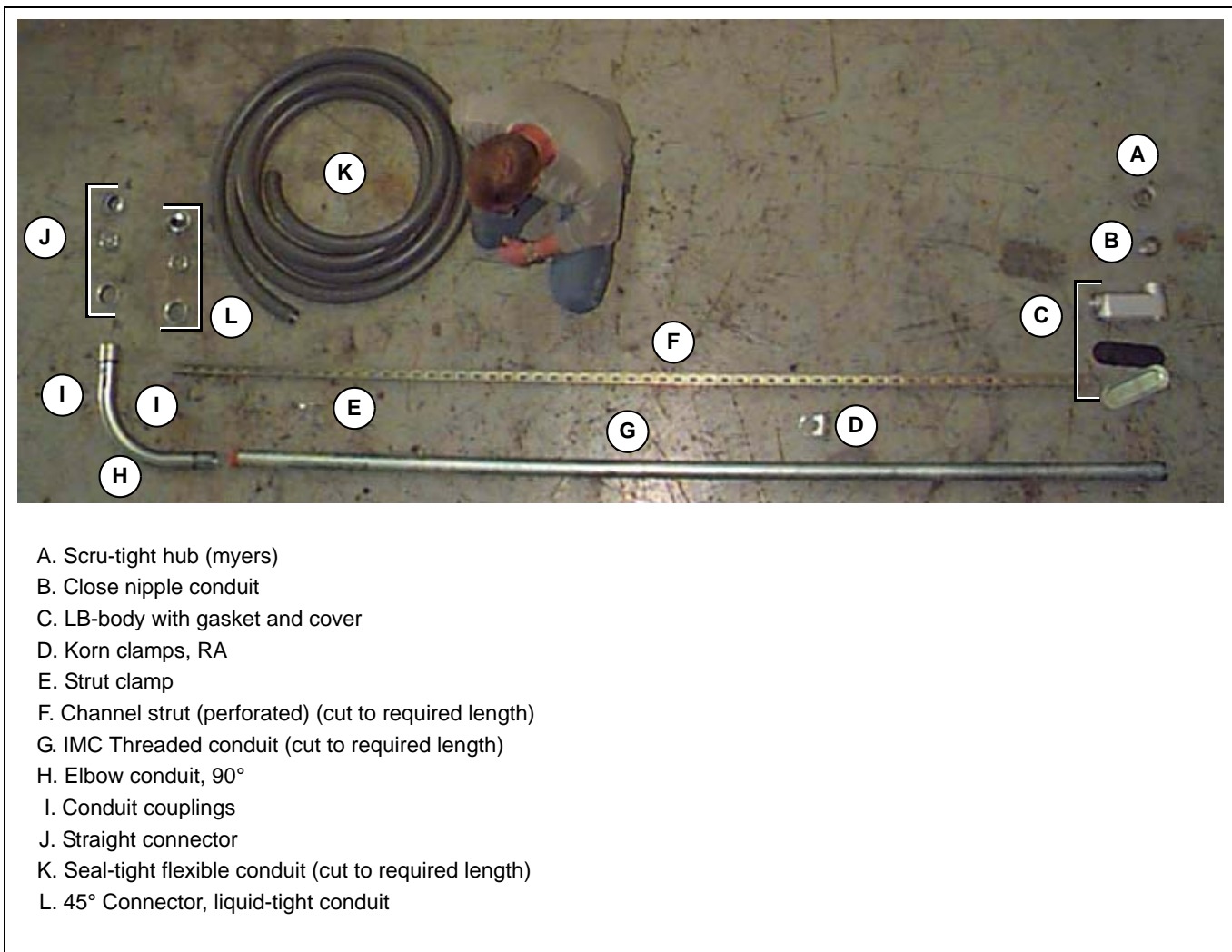
### Wire (1, 3 or 4) Fan Motor(s) as Required by Dryer Size

1. Determine where conduit for each fan motor(s) will exit the power box and knock out hole(s) in power box for conduit (size 1" to 2-1/2" depending on motor size). Install myers hubs. For 3 or 4 fan dryers position conduits as close together as korn clamps will allow. This will leave room for other 1/2" conduits that will exit power box in later steps.

**NOTE:** Conduit and fittings for fan motor(s) are shown in [Figure 5C](#).

**NOTE:** Close up photos of fittings are shown [on Page 49](#).

2. Install LB-bodies at back of power box and run conduit up dryer.
3. Turn conduit into motor window and run conduit or seal-tight into dryer. Install seal-tight from fan motor conduit to fan motor. This allows the motor mount to be adjusted.
4. Pull wires and terminate. Wrap split bolt connections in electrical tape, then mastic tape. Follow manufacturer's instruction manual and terminal wiring diagram on motor nameplate.



**Figure 5C** Fan Motor Electrical Fittings

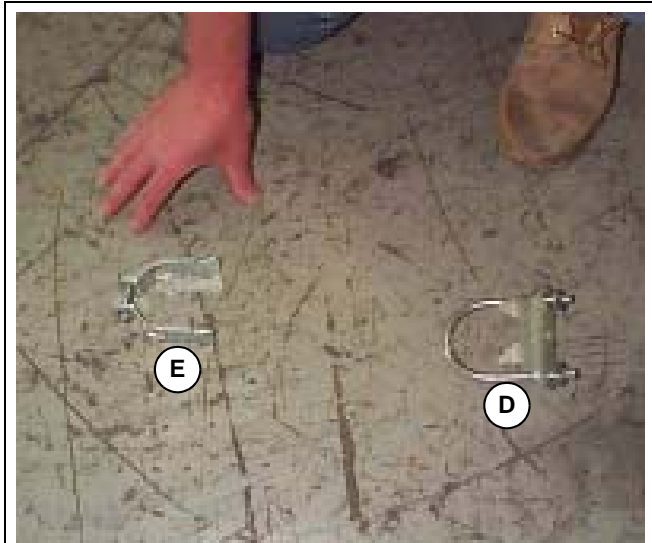


Fittings for Fan Motor Electrical Installation



- A. 1-1/2" Scru-tight hub
- B. Close nipple
- C. 1-1/2" LB-body with gasket and cover

Figure 5D



- D. 1-1/2" Korn clamp
- E. 1-1/2" Strut clamp

Figure 5F



Figure 5E Split Bolt Connectors (6 per fan motor).



- J. 1-1/2" Straight connector
- L. 1-1/2" 45° Seal-tight connector

Figure 5G

## 5. Fan Motors

### Example - Pulling Fan Motor Wires



Figure 5H



Figure 5J



Figure 5I



Figure 5K *Drill hole in angle iron for mini clamp.*

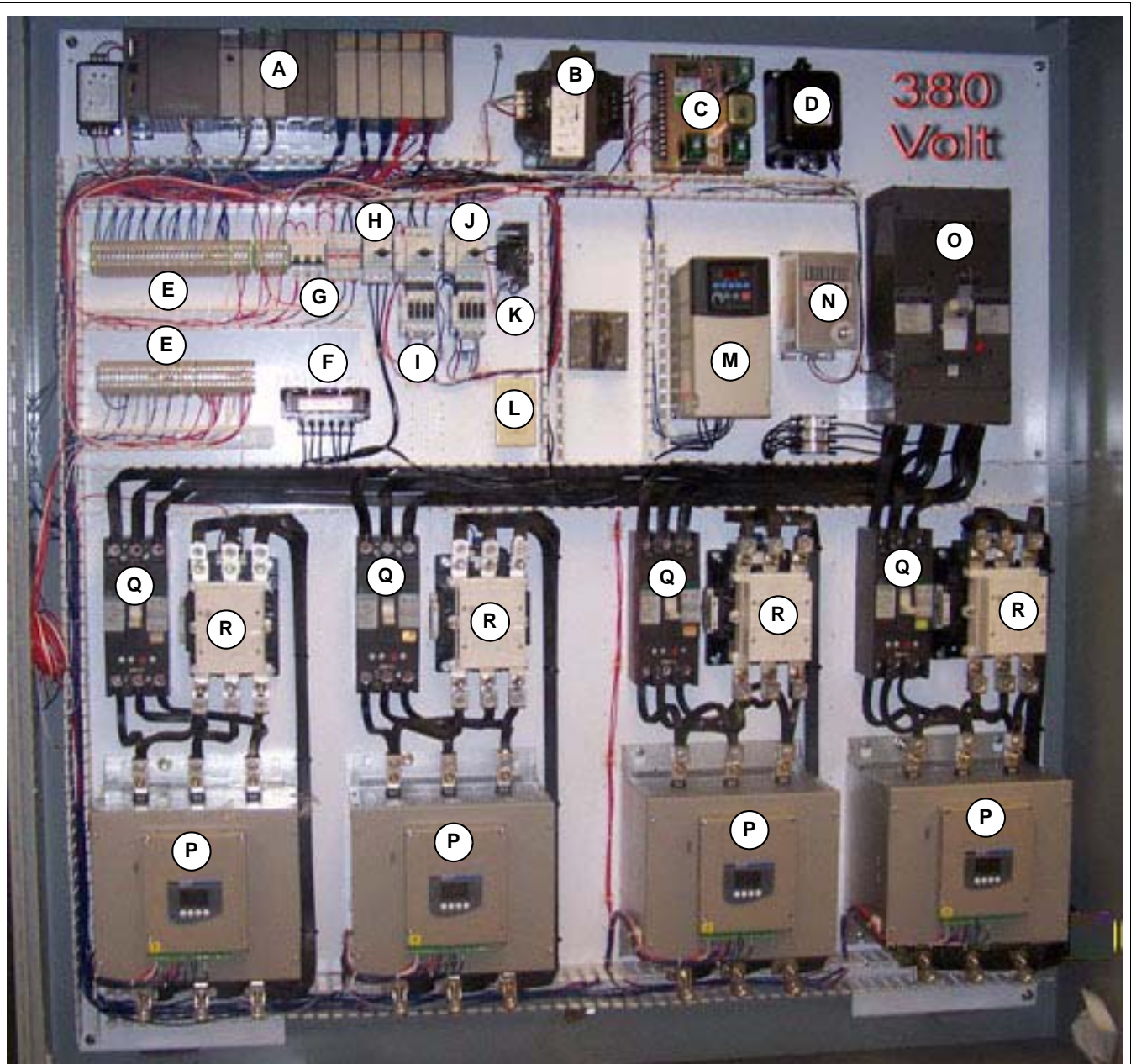
**Example - Making Up Motor Connections**

**Figure 5L** Connections (split bolt connectors) wrapped in electrical tape, then in mastic tape.

## 5. Fan Motors

### Example - Fan Motors Wired in Power Box

**NOTE:** Special ordered 380 VAC package, Ukraine's first 10K tower dryer.



- A. PLC
- B. Transformer
- C. Protectifier
- D. Ignition transformer
- E. Field completed terminations point terminal strip's
- F. In-line reactor
- G. Safety control power
- H. Unload metering device motor starter
- I. Wet conveyers motor starter/contactator

- J. Dry conveyers motor starter/contactator
- K. Moisture sensor 12 VDC power supply
- L. Receptical (for testing purposes only)
- M. Power flex variable drive for metering device
- N. Panel heater
- O. Main disconnect
- P. Fan motor soft start
- Q. Fan motor starter/breaker
- R. Fan motor starter by-pass contactor

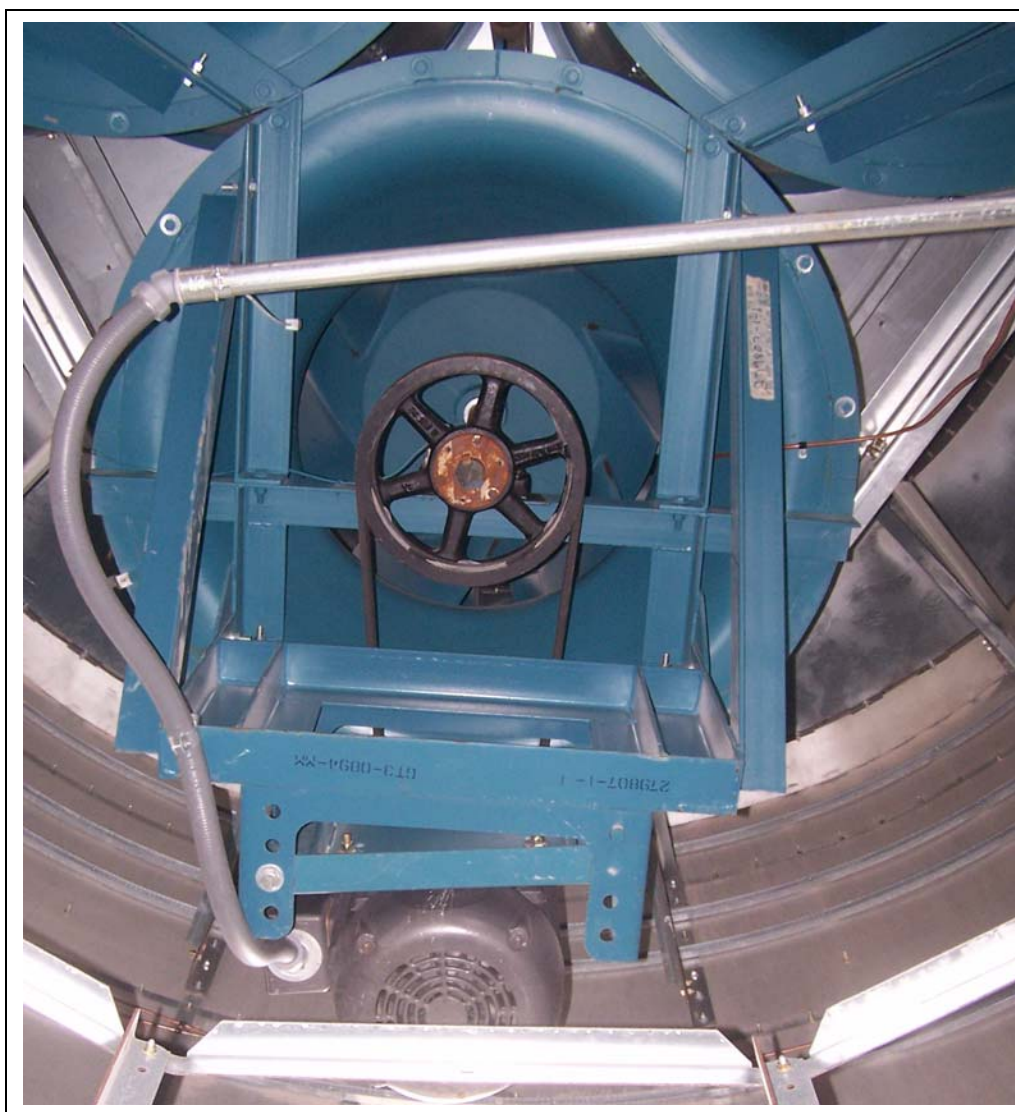
**Figure 5M** Interior View of Power Box

## Install 3/8" Copper Tubing for Air Switches

**NOTE:** 3/8" Copper tubing is same tubing used for pilot fuel train.

1. Run 3/8" copper tubing in motor window - one for each fan.
2. Extend 3/8" copper tubing into fan, but not past the top edge of fan inlet venturi (curved interior of fan).
3. Clamp 3/8" copper tubing inside each fan at midpoint and at bottom edge of venturi.
4. Run 3/8" copper tubing from each fan to power box along respective fan motor conduit. Secure with wire ties.
5. With brass compression fittings, screw 3/8" copper tubing to brass fittings on side of power box. The 3/8" copper air switch tubing must be located properly as described in order for the correct amount of negative pressure/vacuum to register a closed state at the air pressure switch inside the main power panel. (These pressure switches are preset and need no adjustment.)

This in turn signals the computer that all needed safety signals at this point of the start up have been satisfied and that the blowers are running correctly.



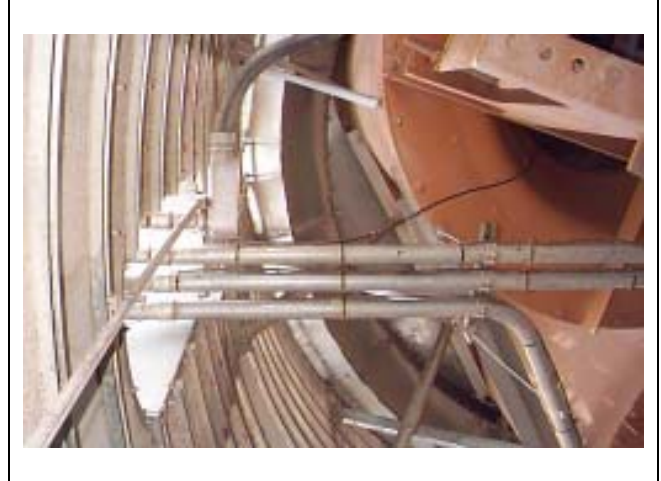
**Figure 6A** Air switch tubing runs to no more than 1" to 2" above top of venturi.

## 6. Air Switches

### Example - Fan Motors Wired and Air Switch Tubing Installed in Dryer



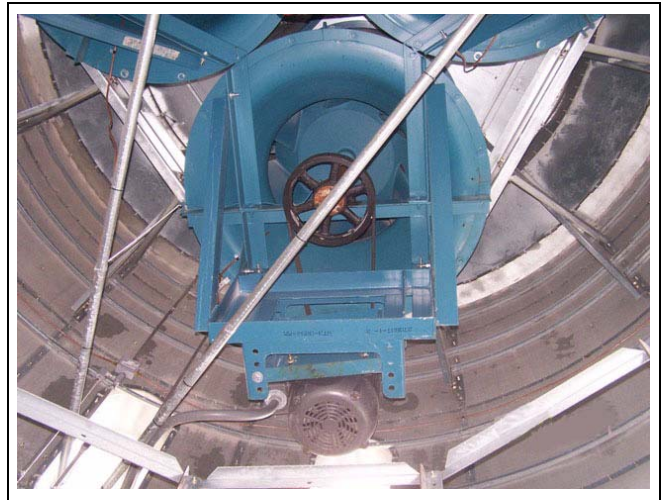
**Figure 6B** L.H. View - Fan motors wired and air switch tubing installed.



**Figure 6D** L.H. View - Fan motors wired and air switch tubing installed.



**Figure 6C** R.H. View - Fan motors wired and air switch tubing installed.



**Figure 6E** Tower dryer electrical access free air window. Looking upward and standing on the metering device access floor. Each fan motor conduit has air switch copper tubing installed and tied securely.

Example - Running Air Switch Tubing



Figure 6F



Figure 6G

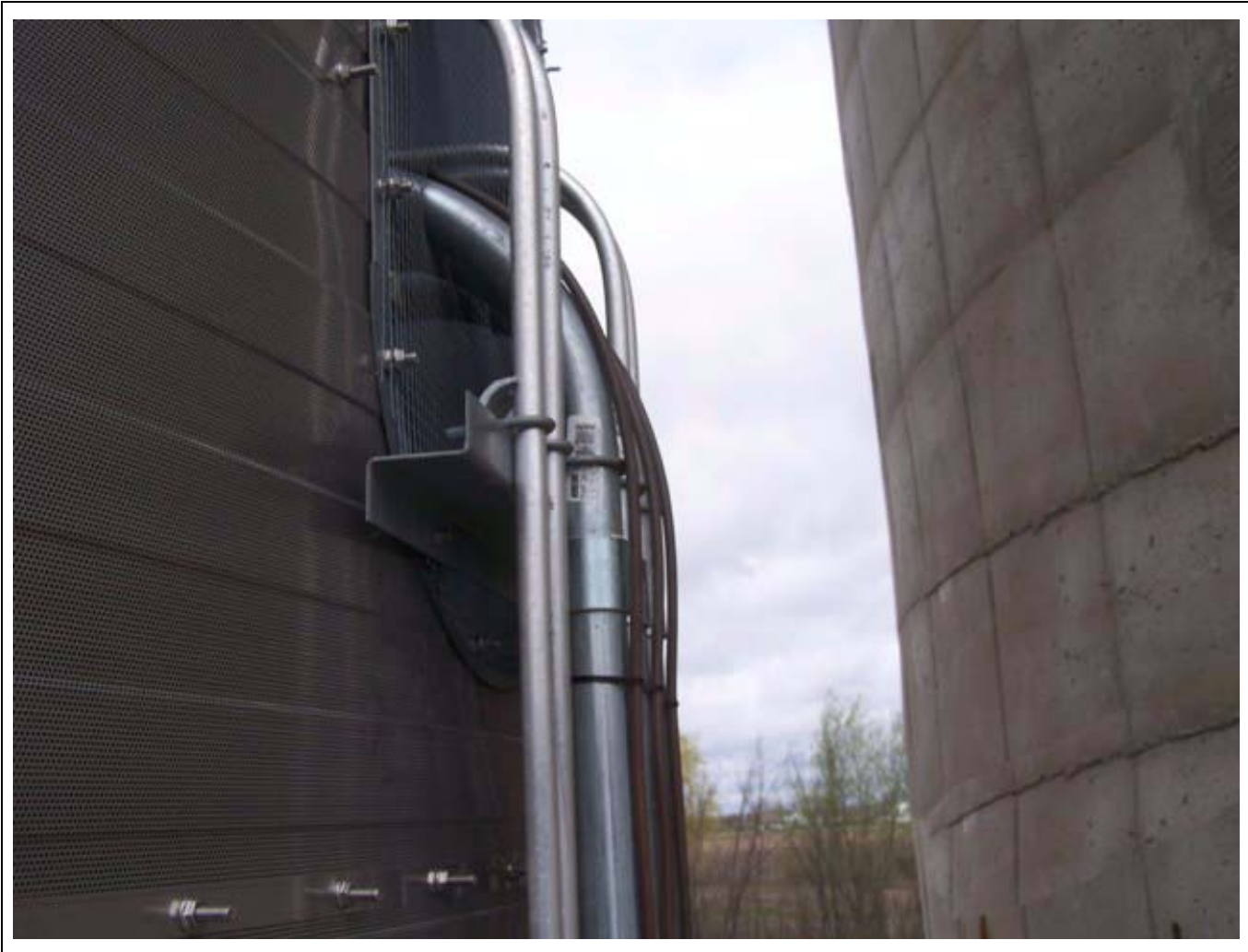


Figure 6H

## 6. Air Switches

### Example - Running Air Switch Tubing (Continued)



**Figure 6I**



**Figure 6J** Brass connectors connect 3/8" copper tubing to air switches.



**Figure 6K** Air Switch Tubing Installed

**NOTE:** Use wire ties to secure the 3/8" copper air lines to the appropriate motor conduit. Wire ties should be secure and spaced evenly along the length of the dryer conduit to each respective motor. Verify that the correct air line is positioned to the correct motor conduit.





**Important Safety Precaution:**  
*All electrical installations must be made by qualified personnel.*

See appendices [on Pages 113-125](#) for wiring notes and schematics, etc. ([See Pages 120 and 121.](#))

During dryer construction, metering device motor is installed to gearbox on metering device.  
Specifications: Toshiba, inverter-duty, 3 phase, AC. ([See Figure 7A.](#))



**Figure 7A** Toshiba Motor as Shipped

1. Determine where conduit for metering device motor exits back of power box and knock out hole for 1/2" conduit. Install myers hub.
2. Install LB-body at back of power box and run conduit up dryer.
3. With 90° bend (parallel to other conduits) turn conduit into motor window.
4. Install LB-body and run conduit down inside dryer. Keep conduit as close to inside wall of dryer as possible.
5. Use knock out set to punch 1/2" hole in bottom of walk-in cooling section floor and run conduit through floor.
6. With 45° bend turn and run conduit to approximately 4' from metering device. Clamp conduit to inner wall of hopper.
7. Connect to metering device motor with flexible conduit.
8. Pull wires and terminate. Follow terminal wiring diagram on motor nameplate.

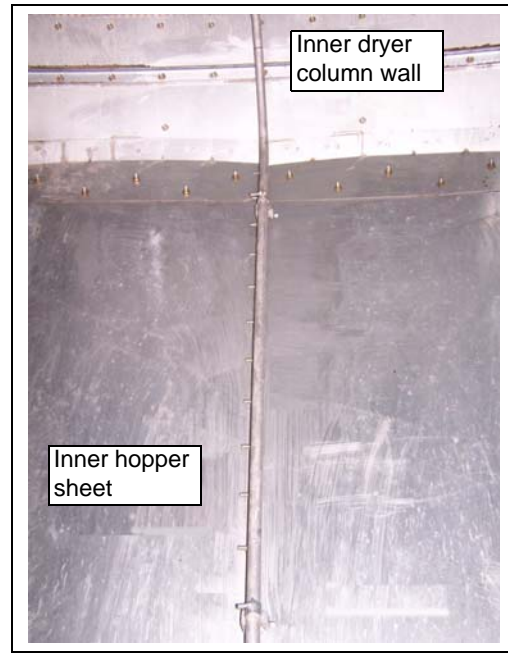
**NOTE:** *Wire size varies with application.*

**NOTE:** [Refer to Appendix C Power Box Wiring - Field Notes on Page 120 and 121](#), for wires, colors and connections.

## 7. Metering Device Motor

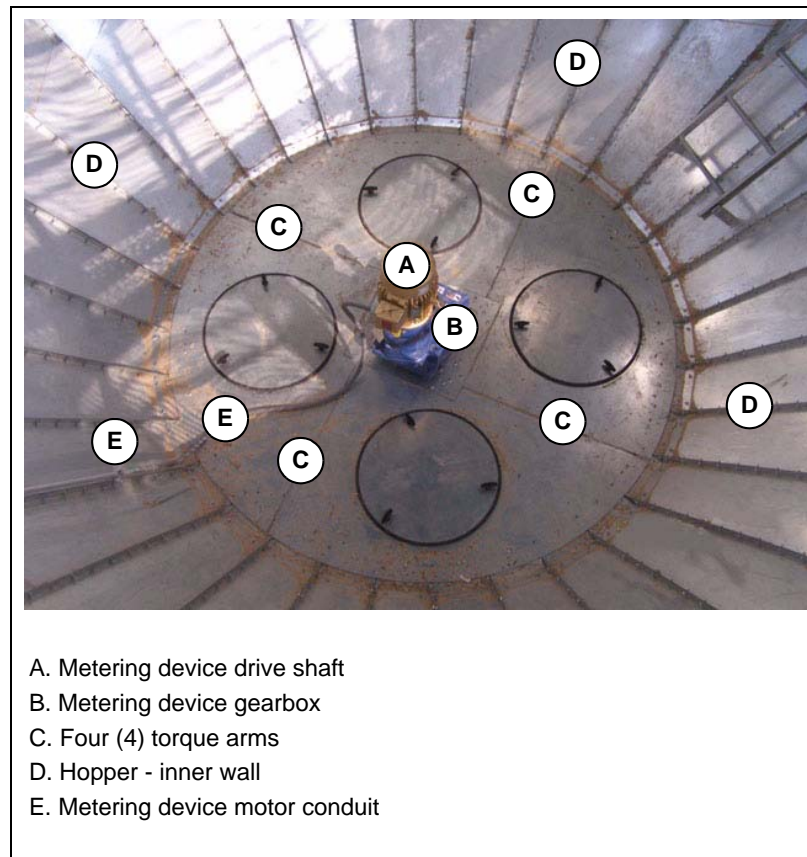


**Figure 7B** Typical conduit installations for a Zimmerman unload system.



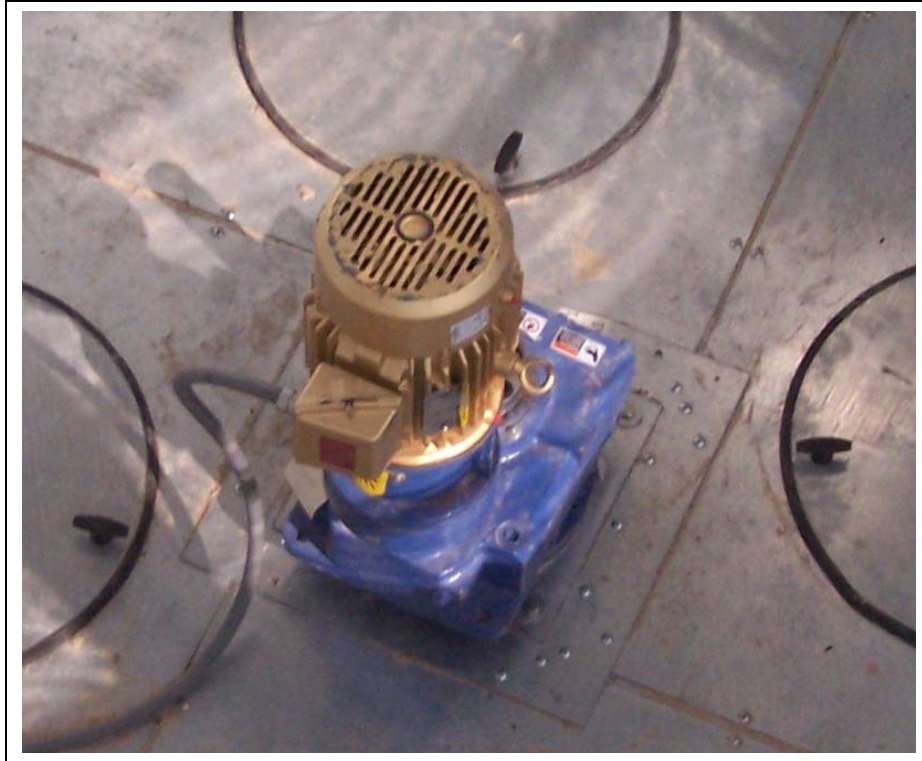
**Figure 7C** Conduit GSI style unload system, the conduit comes in window and straight down to metering device floor. Then attach a short length seal-tight to motor.

### Example 1 - Metering Unload Device Components



**Figure 7D** Metering Device Motor Installed

**Example 2 - Metering Unload Device Wiring (Dryer Shown After Operation)**



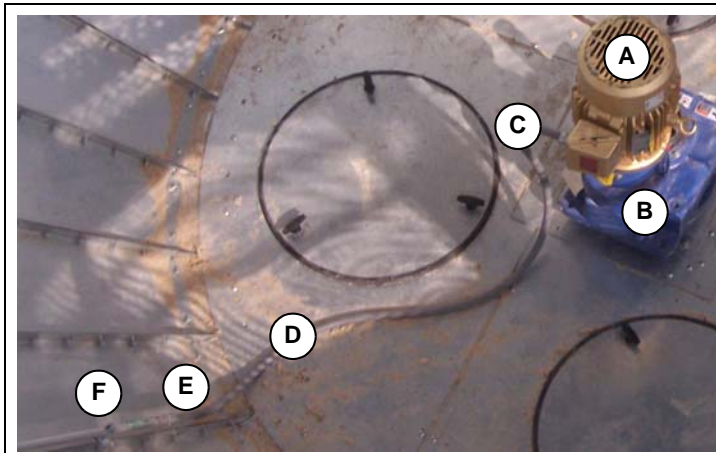
**Figure 7E** *Typical GSI Style Metering Device Install*



**Figure 7F** *Typical Zimmerman Style Unload Metering Device Installations*

## 7. Metering Device Motor

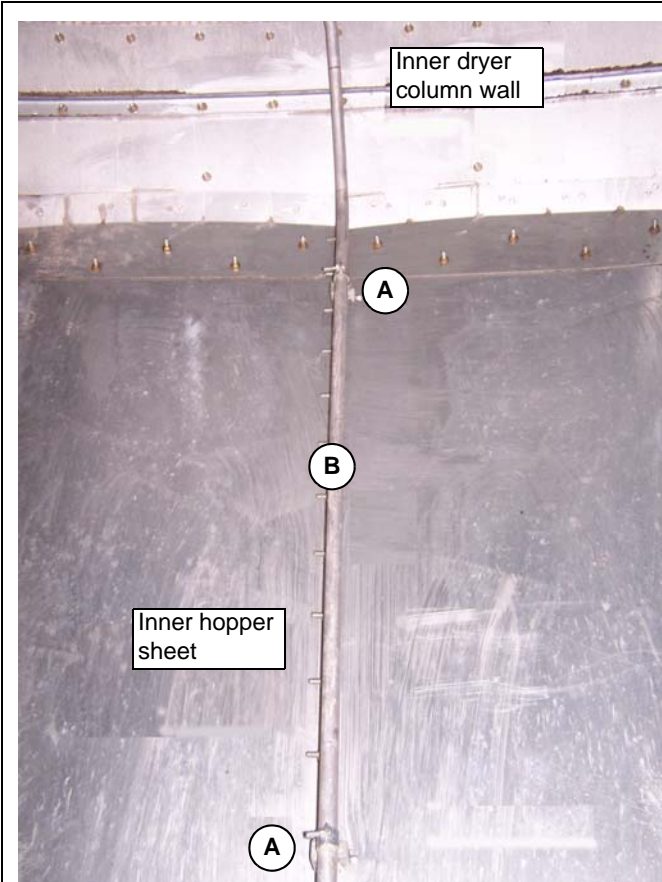
### Example 2 - Metering Unload Device Wiring (Dryer Shown After Operation) (Continued)



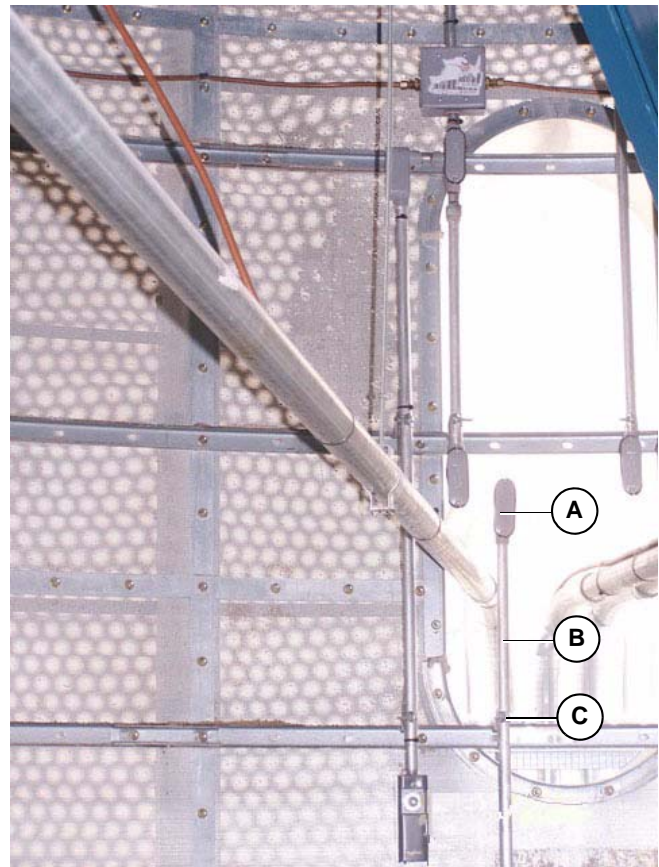
Conduit installed to metering unload device and along inner wall of hopper with the following fittings.

- A. Unload motor
- B. Unload reducer
- C. Seal tight fitting with 3/4" to 1/2" reducer washers installed
- D. Flex seal-tight conduit
- E. Seal-tight to rigid conduit connections
- F. Conduit 'mini' and beam clamps used to secure conduit to the inner hopper.

**Figure 7G** Below Inside walk around platform at metering device level.



- A. 1/2" Conduit clamps and beam clamps used to secure conduit to inner hopper.
- B. 1/2" Aluminum conduit.



- A. 1/2" Conduit LB junction
- B. 1/2" Aluminum conduit
- C. Mini and beam clamp for securing conduits.

**Figure 7H** Below inside walk around platform, down interior wall sheet and continuing down the inner hopper sheet. Changing into seal-tight and completed to motor.

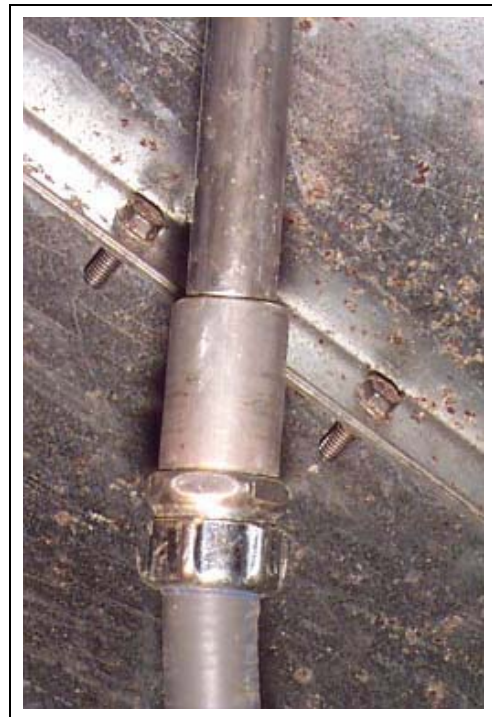
**Example 2 - Metering Unload Device Wiring (Dryer Shown After Operation) (Continued)**



**Figure 7I** *Close Up - Beam Clamp*



**Figure 7J** *Close Up - Conduit Coupling*



**Figure 7K** *Liquid-Tight Conduit Straight Connector*

## 8. Interior High-Limits, Thermostat, Plenum Temperature Sensor



**Important Safety Precaution:**  
*All electrical installations must be made by qualified personnel.*

See appendices [on Pages 113-125](#) for wiring notes and schematics, etc. ([See Pages 120 and 121.](#))

### **Interior High-Limits, Adjustable Plenum High-Limit Thermostat (Overheat), Plenum Temperature Sensor (RTD)**

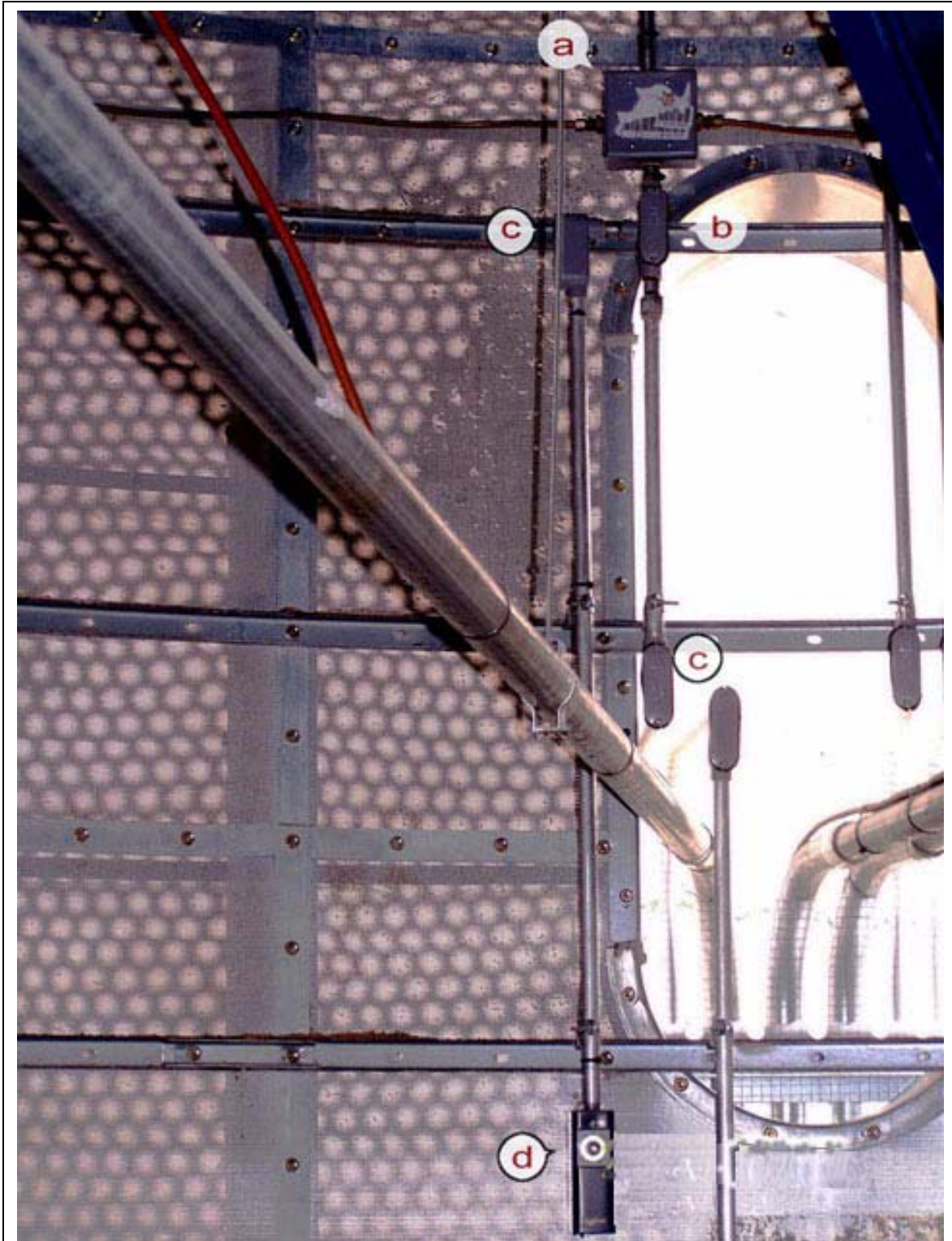
1. Determine where conduit for interior high-limit, adjustable plenum high-limit thermostat and plenum temperature sensor exits power box and knock out hole for a single 1/2" conduit. Install myers hub.
2. Install LB-body at back of power box and run conduit up dryer.
3. Bend conduit 90° to turn conduit into dryer window (usually the motor window) and run conduit into dryer. Install LB-body and run conduit up inside walk-in cooling section to just above motor window.
4. Connect interior high-limit to conduit.
5. Extend copper capillaries from interior high-limit (horizontally to right and left) and secure with insulated clips and 5/16" whiz nuts to be located for easy access.
6. Install 4" junction box above interior high-limit with 1/2" x 2" nipple.
7. Install adjustable plenum high-limit thermostat to 4" junction box with 1/2" close nipple.

#### **NOTICE**

***High-limit copper capillaries and 3/8" O.D. copper lines can be damaged easily. These sensors need care in placement.***

- a. Verify that the lines wrapping around the dryer are directly level with the 4 way connections box and remain as straight and level as possible all the way around the dryer.
- b. Verify that all lids and fittings are tight and gaskets are used where applicable.

Example 1

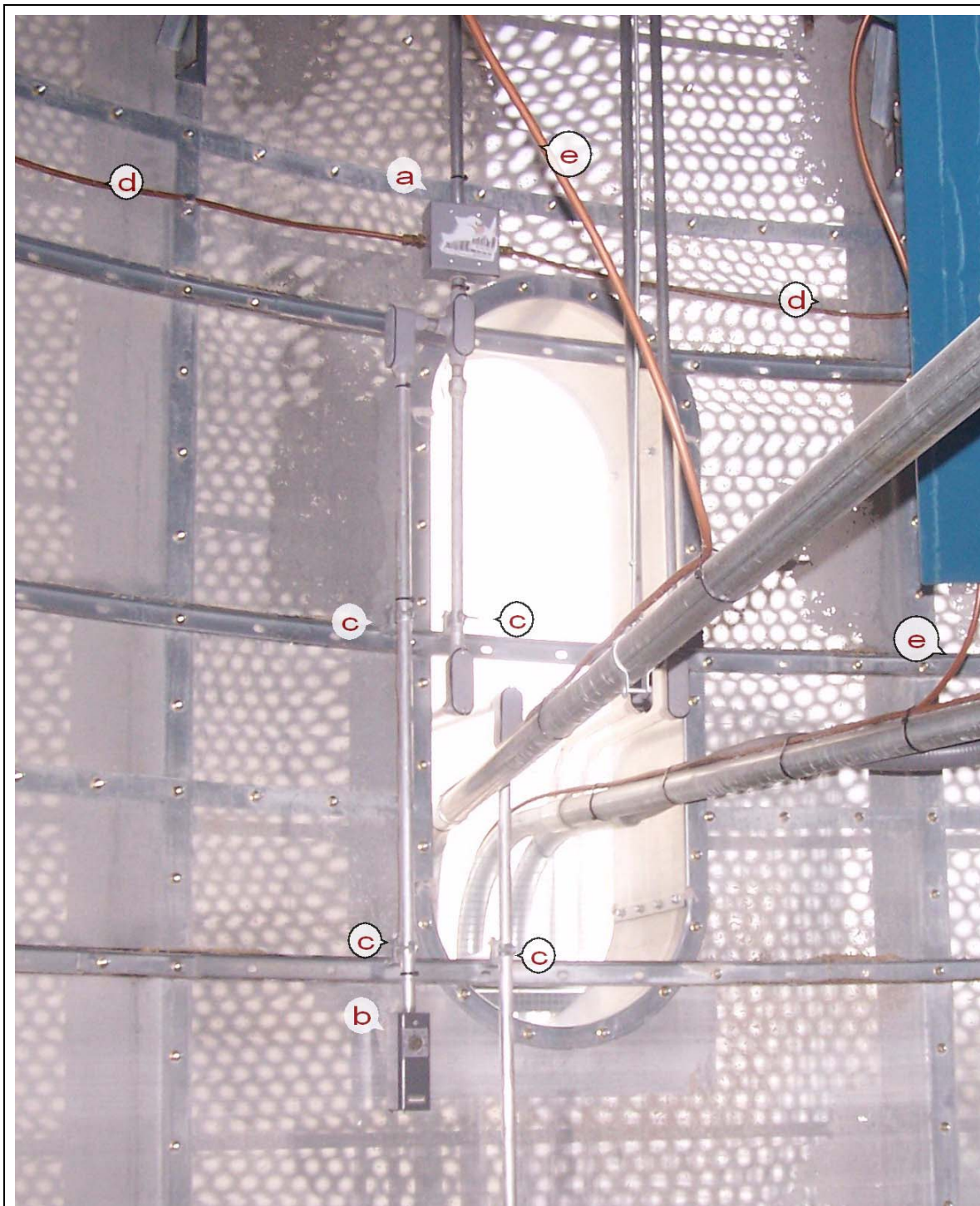


- A. Double inside high-limit junctions box and capillaries
- B. 1/2" Conduit tee junction
- C. 1/2" Conduit LB junctions
- D. Adjustable plenum high-limit sensor

Figure 8A

## 8. Interior High-Limits, Thermostat, Plenum Temperature Sensor

### Example 2 - 4 Fan, 7000 BPH Dryer After Operation



- A. Double/inside high-limit
- B. Adjustable plenum high-limit
- C. Conduit supported to plenum rolled channel
- D. Left/right capillary for inside high-limit
- E. 3/8" Copper air line for proof at fan/blower

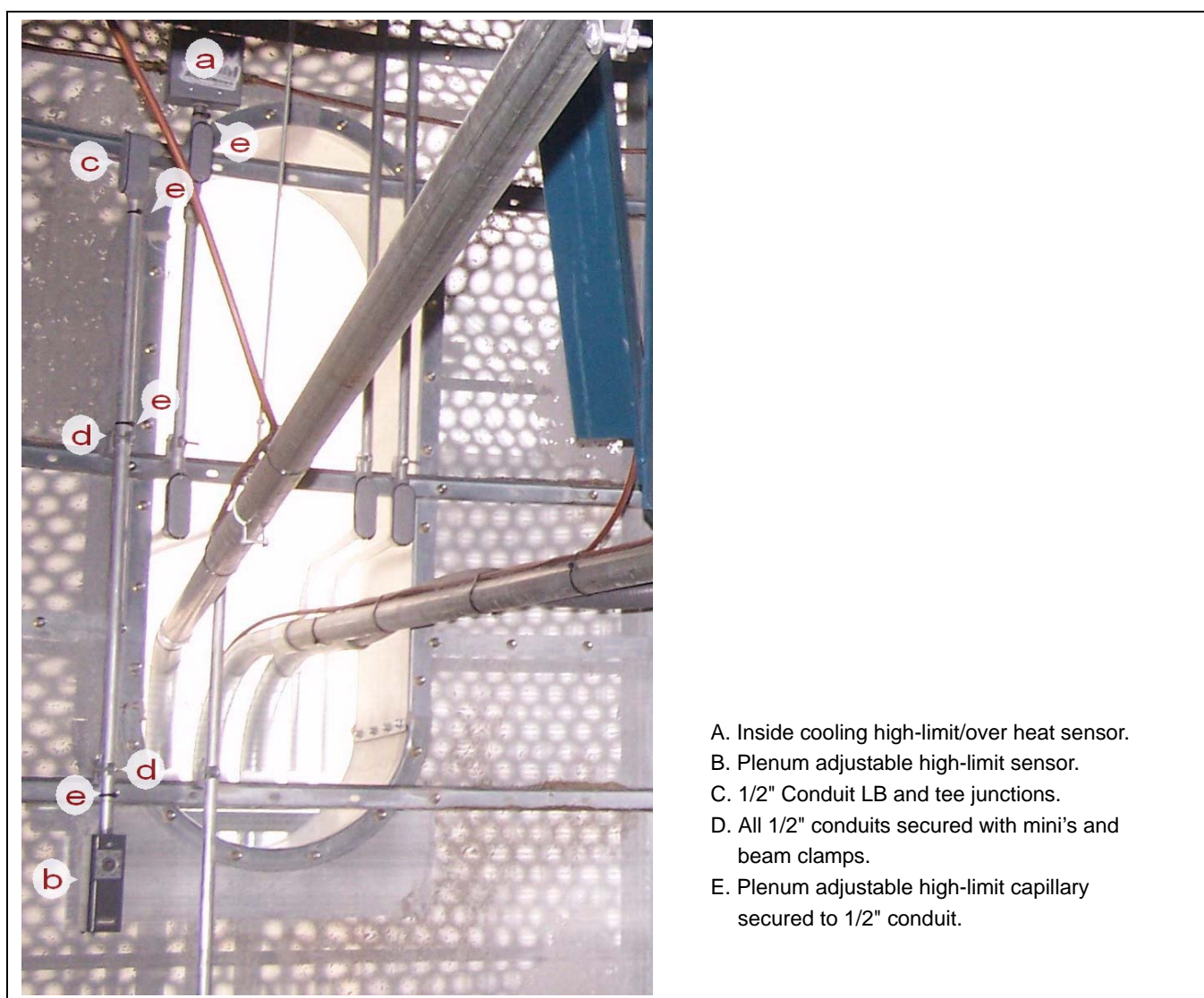
Figure 8B



## 8. Interior High-Limits, Thermostat, Plenum Temperature Sensor

8. Drill hole in hopper divider from above and run conduit up from 4" junction box to walk-in heating section of dryer.
  9. Secure conduit to dryer with mini clamps. *(See Figure 8A on Page 63 and Figure 8B on Page 64.)*
  10. Approximately 3' above heat section walkway, the plenum RTD temperature sensor will be installed later at the correct level in the burner section.
  11. Feed adjustable plenum high-limit thermostat capillary up outside of conduit to conduit tee in walk-in heating section. Roll up access tube tie with wire ties.
  12. Secure copper capillary to dryer wall with insulated clips and 5/16" whiz nuts.
- NOTE:** Do not mount capillary on plenum channels.
13. Pull wire or cable and terminate.

*See Appendix C Power Box Wiring - Field Notes on Pages 120 and 121.*



**Figure 8C**

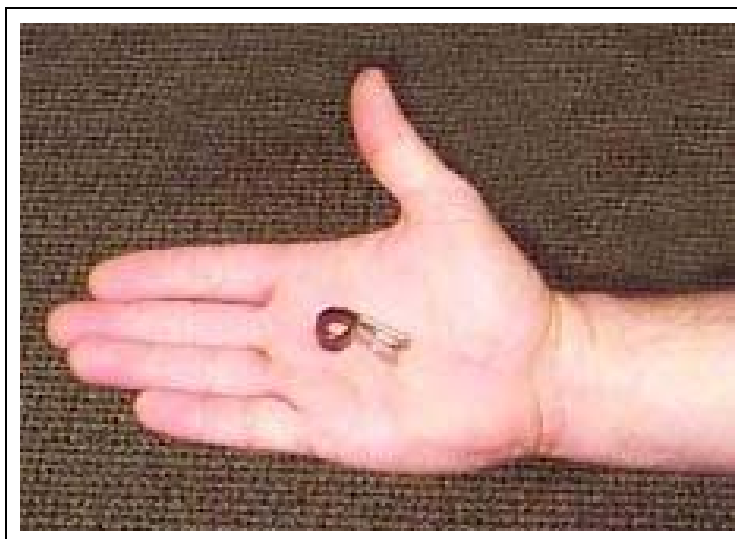
**NOTE:** Notice the placement of the plenum adjustable high-limit. Positioning is vital for end-user accessibility during changing seasonal drying conditions and grains.

## 8. Interior High-Limits, Thermostat, Plenum Temperature Sensor



- A. 1/2" Conduit for plenum temperature sensor
- B. Installed through divider hopper also
- C. Note 1/2" conduits for flame sensor and ignitor

**Figure 8D**



**Figure 8E** Insulated Clip for Copper Capillary (GT4-0057 and GT4-0148)



**Important Safety Precaution:**  
*All electrical installations must be made by qualified personnel.*

See appendices [on Pages 113-125](#) for wiring notes and schematics, etc. ([See Pages 120 and 121.](#))

## Exterior High-Limits (Overheats)

During construction, upper, middle and lower exterior high-limits (and their copper capillaries which encircle dryer) are installed on exterior of dryer.

During dryer construction, one 1/2" conduit for the three (3) exterior high-limits is installed behind ladder to approximately 10' above foundation.

1. Determine where conduit for exterior high-limits exits power box and knock out hole for 1/2" conduit. Install myers hub.
2. Install LB-body at back of power box. Run conduit up and around dryer to existing conduit.
3. Pull wires and terminate. [See Appendix C Power Box Wiring - Field Notes on Page 120 and 121.](#)



**Figure 9A** Exterior high-limit sensor with gas-filled copper tubing is installed inside copper capillary at factory.



**Figure 9B** One exterior high-limits with copper capillaries.



**Do not cut off end of gas-filled copper tubing.**

## During Dryer Construction

**Upper exterior high-limits** are installed on perforated sheets approximately 5" below top rows of solid sheets.

**Middle exterior high-limits** are installed on perforated sheets between the upper and lower exterior high-limits.

**Lower exterior high-limits** are installed on perforated sheets, above or below middle row of solid sheets, 20' below upper exterior high-limits. ([See Page 9C on Page 68.](#))

## 9. Exterior High-Limits

### NOTICE

*High-limit copper capillaries and 3/8" O.D. copper lines can be damaged easily. These sensors need care in placement.*

1. Verify that the lines wrapping around the dryer are directly level with the 4 way connections box and remain as straight and level as possible all the way around the dryer.
2. Verify that all lids and fittings are tight and gaskets are used where applicable.



- A. Being the top/upper high-limit over heat.
- B. Being the middle high-limit over heat.
- C. Being the bottom/lower high-limit over heat.

**Figure 9C** Outside high-limit positions are as indicated.



- A. Upper and lower bindicators and grain temperature RTD sensor
- B. Wet moisture sensor
- C. Dry moisture sensor
- D. Outside high-limits/overheats
- E. Grain temperature sensor
- F. Bottom/lower high-limit sensor

**Figure 9D** Side View - Conduit installed on 4 fan dryer.

## 10. Sensors



**Important Safety Precaution:**  
*All electrical installations must be made by qualified personnel.*

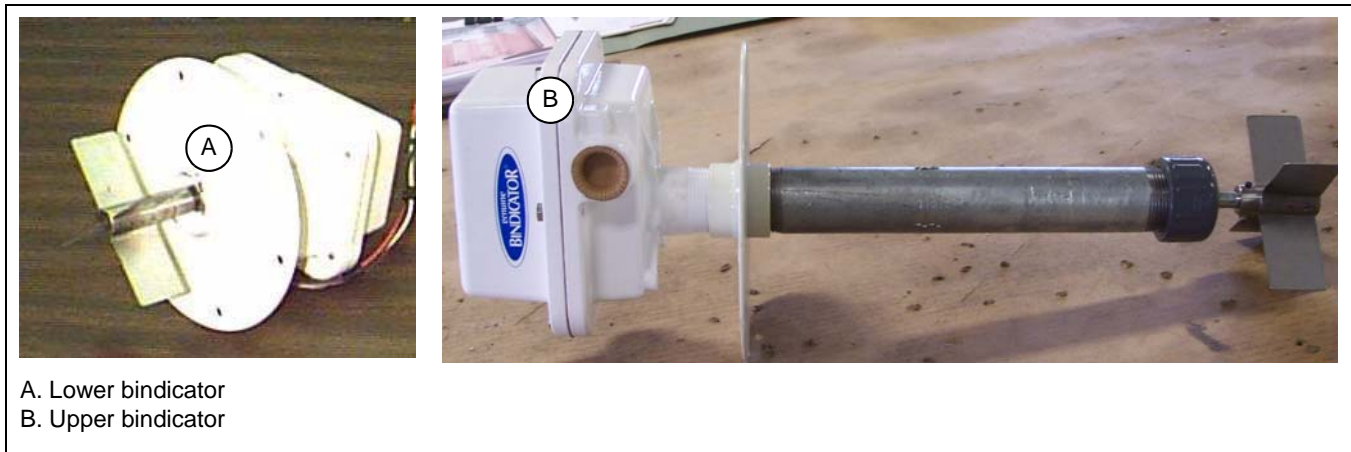
See appendices [on Pages 113-125](#) for wiring notes and schematics, etc. ([See Pages 120 and 121.](#))

### Bindicator(s) and Grain Temperature Sensors (RTDs)

During dryer construction, bindicator(s) are installed on exterior of roof garner section.

[See Figure 10A](#) for standard upper and lower bindicator placements.

One 1/2" conduit for bindicator and grain temperature sensors is installed beside ladder (and to left of exterior high-limits conduit) to approximately 10' from top of discharge hopper.



**Figure 10A** Bindicators (Wired for demonstration.)

### Bindicator(s)

1. Determine where 1/2" conduit for bindicator(s) exits power box and knock out hole. Install myers hub.
2. Install LB-body at back of power box.

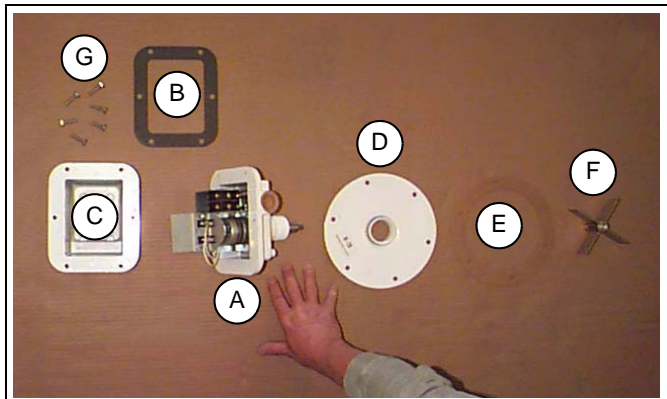
**IMPORTANT:** [See Grain Temperature Sensors Probe on Page 72](#) before installing bindicator conduit. Grain temperature sensor cables are run in same conduit with bindicator wires.

3. After installing conduit tee for grain temperature sensors, run 1/2" conduit to existing bindicator conduit.
4. Pull wire/cable and terminate. ([See Figure 10B on Page 71.](#))

[See Appendix C Power Box Wiring - Field Notes on Pages 120 and 121.](#)



Figure 10B #14 Fork



- A. Bindicator
- B. Gasket
- C. Cover
- D. Mounting bracket
- E. Mounting gasket ring
- F. Blades
- H. Hardware

Figure 10C Bindicator as Shipped

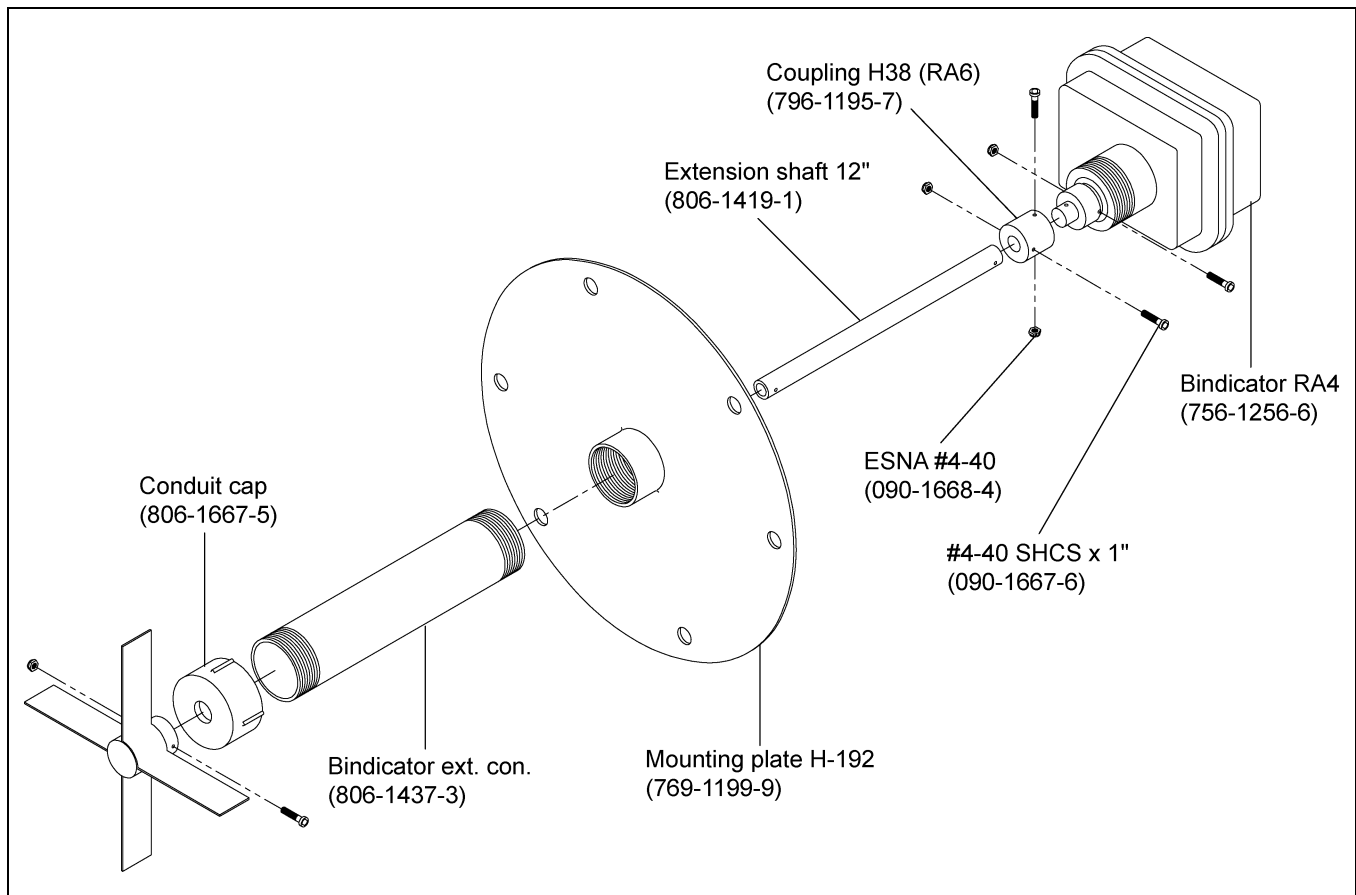


Figure 10D RA6 Bindicator

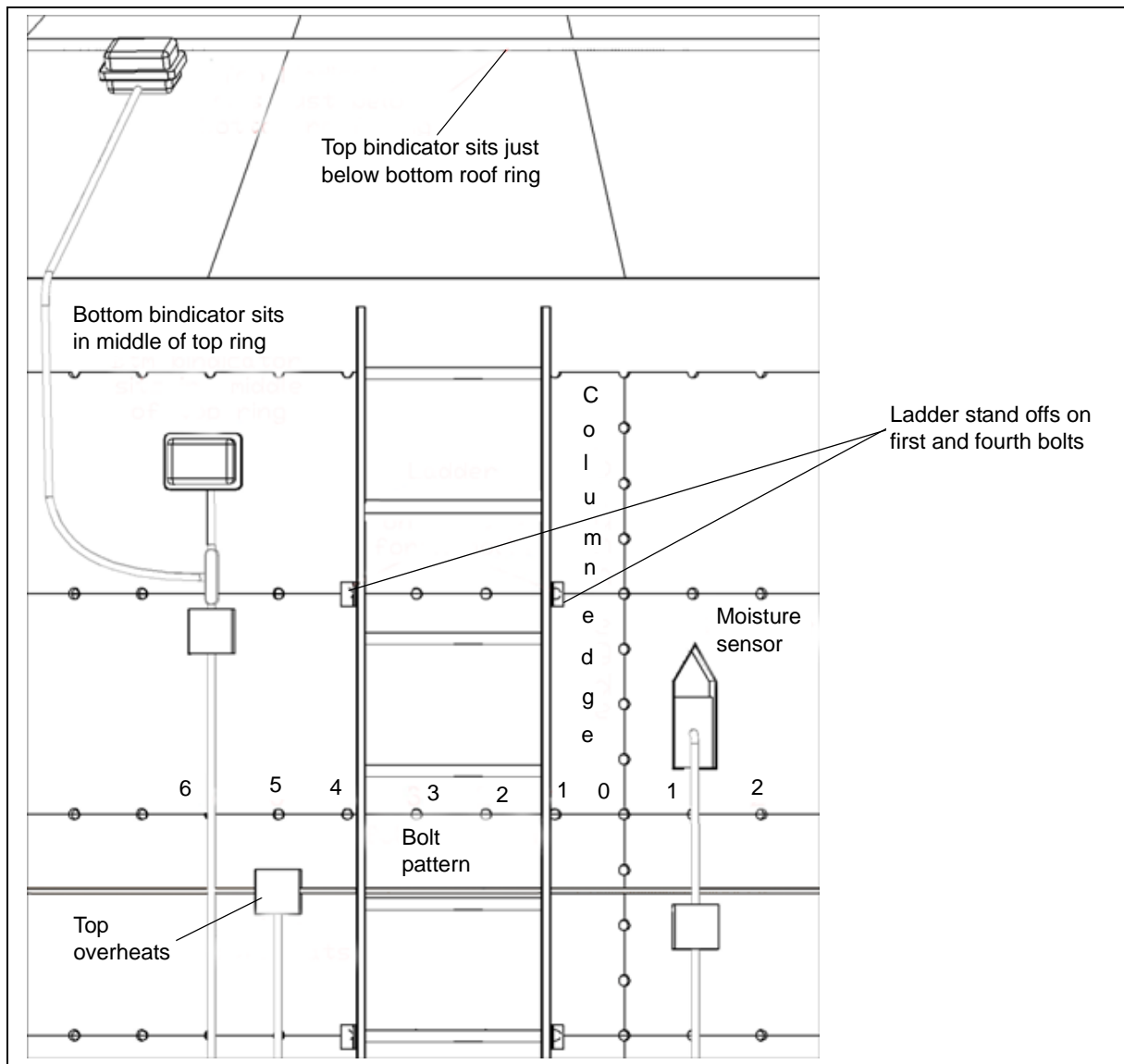
## 10. Sensors

### Grain Temperature Sensors Probe

**NOTE:** Grain temperature sensor (RTD) cables are pulled in the 1/2" bindicator conduit and RTD's were replaced with grain temperature probe.

1. While running 1/2" bindicator(s) conduit, install conduit tee for grain temperature RTD sensors at screen 15" to 20" above the top of divider hopper.
2. Run flexible conduit from conduit tee to sensor probe.
3. Run flexible seal-tight conduits from 4 way junction box and/or conduit tee connector to bottom bindicator. Continue from the top of 4 way junction box and/or conduit tee connector with aluminum 1/2" conduit up the outside of the dryer to the outer roof sections within 16" of the upper bindicator. Use flexible seal-tight conduit and fittings to connect to bindicator. **NOTE:** Be sure to secure all lines to dryer for stability.
4. Pull shielded cable for grain temperature sensor with bindicator wires and terminate.

[See Appendix C Power Box Wiring - Field Notes on Pages 120 and 121.](#)



**Figure 10E** Sensor and Conduit Location



## Example - Wiring Bindicator(s)



**Figure 10F** One option available for installations. Lower bindicator.



**Figure 10G** Typical install at bindicator's with the wet moisture = Sensor housing installed.



**Figure 10H** Excessive length's of flex seal-tight conduit is discouraged.

Wiring Bindicator(s) (Continued)

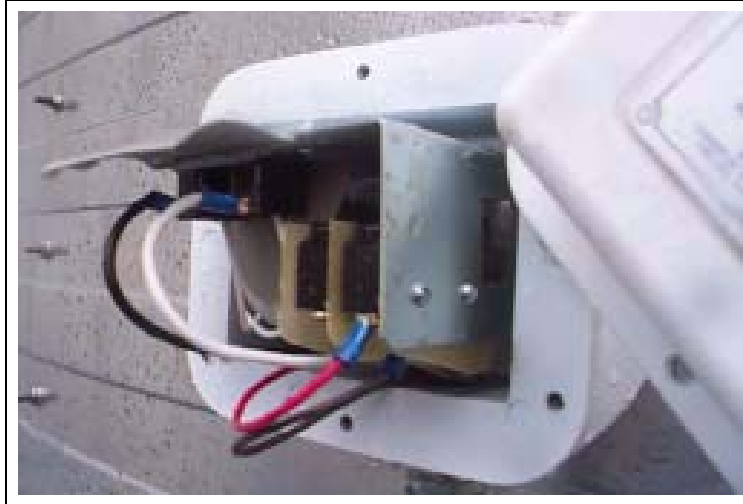


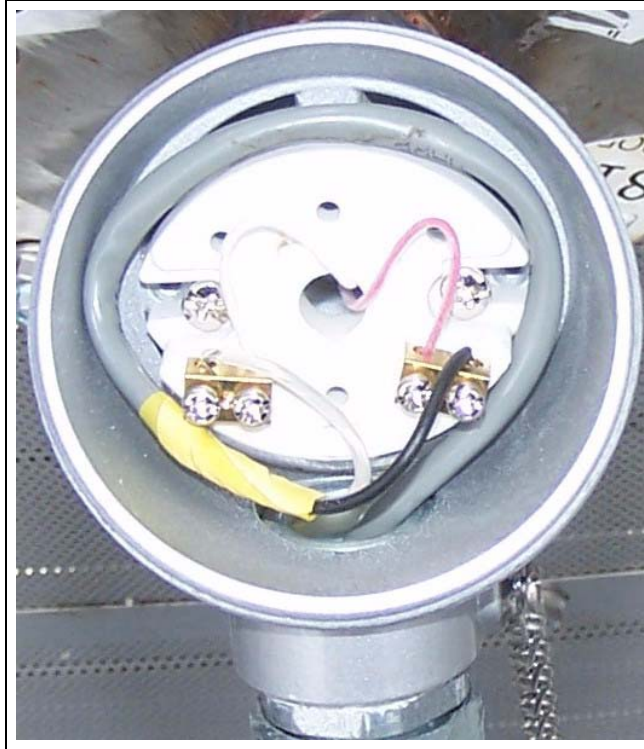
Figure 10I Close Up - Bindicator Wired

Example - Grain Temperature Sensors Installed



- A. Grain temperature RTD sensor conduit tee.
- B. Upper and lower bindicator and grain temperature RTD sensor conduit.

Figure 10J Installing conduit tee on bindicator conduit for grain temperature sensors cables.

**Example - Grain Temperature Sensors Installed (Continued)**

**Figure 10K** *Connections at Grain Temperature RTD Sensor.*



**Figure 10L** *Grain RTD mounted and conduit tee with seal-tight completed and tight.*

Example - Bindicator(s) and Grain Temperature Sensors Installed



- A. Conduit tee installations
- B. Outside bottom/lower high-limit/overheat
- C. Conduit LB installations
- D. Top/bottom bindicator and grain temperature RTD sensor conduit.
- E. Dry moisture sensor conduit
- F. Wet moisture sensor conduit
- G. Outside high-limit/overheat sensors

Figure 10M Side View - Conduit installed on 4 fan dryer.

## Moisture Sensor Kit



**Figure 10N** Low Noise GT4-1659 Series

**NOTE:** Moisture kit arrives together in the dryers load with operators panel, main panel and specified supply of an aluminum 1/2" conduit package.



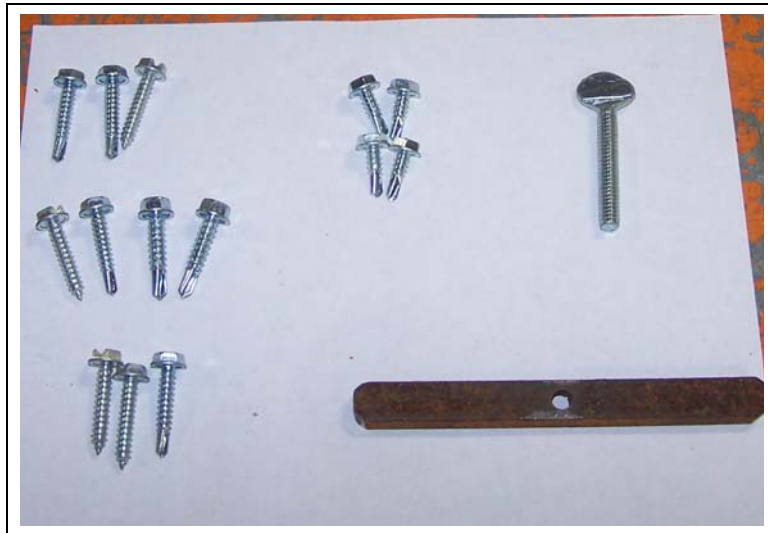
**Figure 100**

## 10. Sensors

### Moisture Control Optional Tower Panel (GT4-0417)

Part #	Description	Qty	U/M
1EL3039	Cable, 20/5 Cable	250	FT
2EL0212	Power Supply, 15V, Single Alternate Power	1	EA
GT4-1659	Moisture Sensor Assembly for D04-1418 - 32' Cable	2	EA
602N175	Column Sensor Bracket with Decal	1	EA
GT1-1214	Plate, DMC Sensor Mount	1	EA
GT1-1214C	Sensor Cover - Bracket	2	EA
S-280	Screw, SDS #10-16 x 5/8" HWH ZN	4	EA
S-7466	Screw, SDS #10-16 x 3/4" HWH ZN Grade 2	4	EA
GT3-0898	Conduit, 1/2" Threaded Aluminum	120	FT
006-1309-1	Fuse, Terminal Block - Cage CLA	1	EA
1EL0719	Fuse, AGC2 250V 2 Amp 1/4 " x 1-1/4"	1	EA

**NOTE:** Quantities at conduit and cable may vary with tower dryer height sizing.



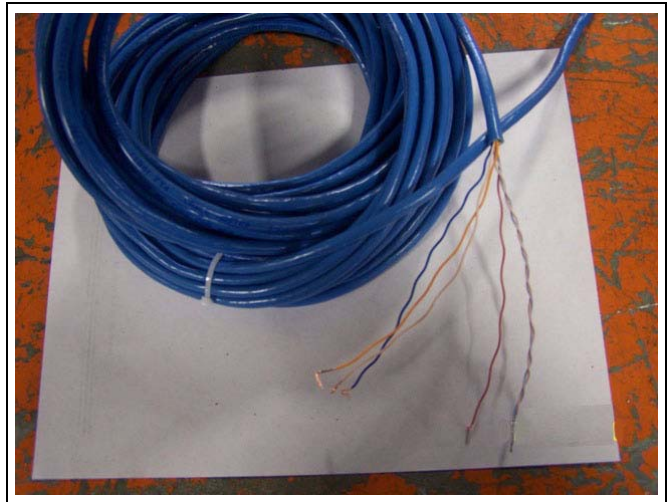
**Figure 10P** Wet/Dry Hardware



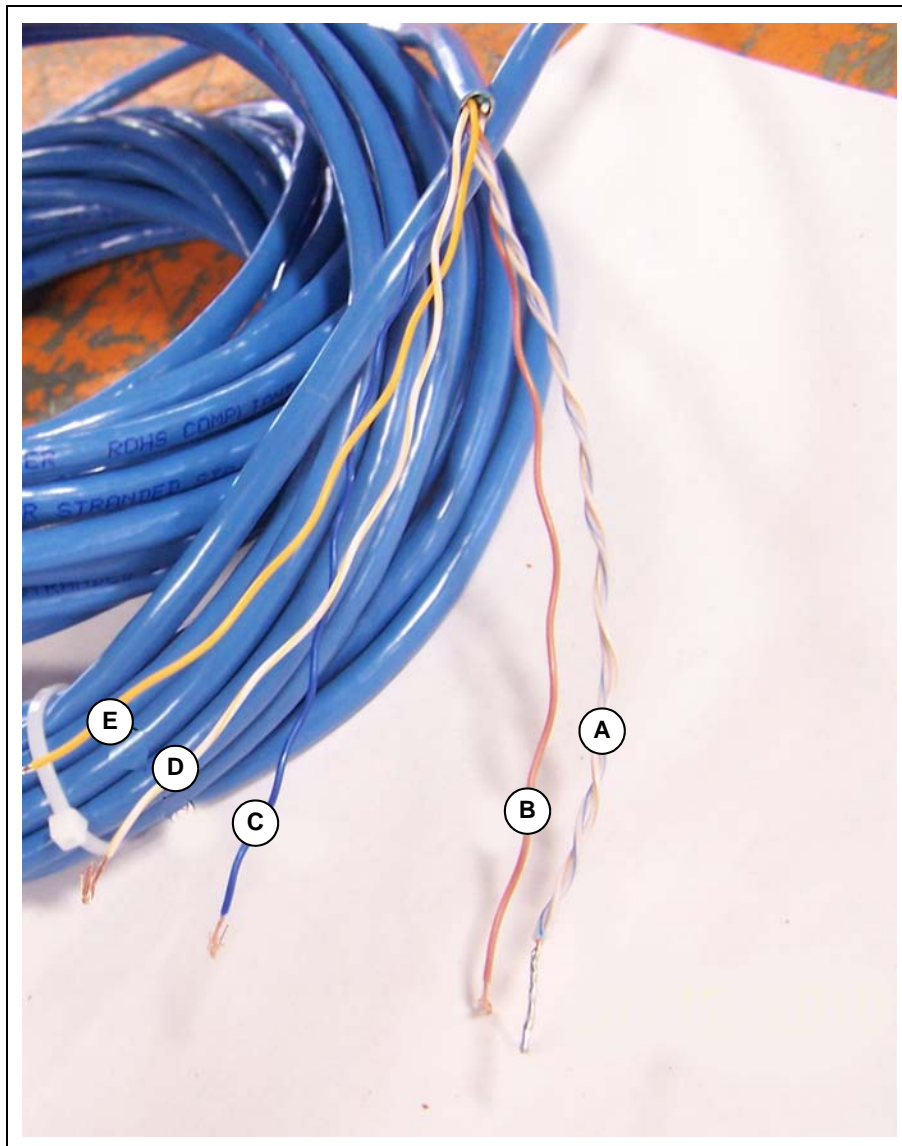
**Figure 10Q** Dry Sensor Mounting Plate and Bracket



**Figure 10R** Flow Directional Sticker



**Figure 10S** sensor 20/5 cable attached too moisture Sensor - As supplied from factory.



**Figure 10T** Moisture sensors 20/5 cable prepared from factory.

## 10. Sensors

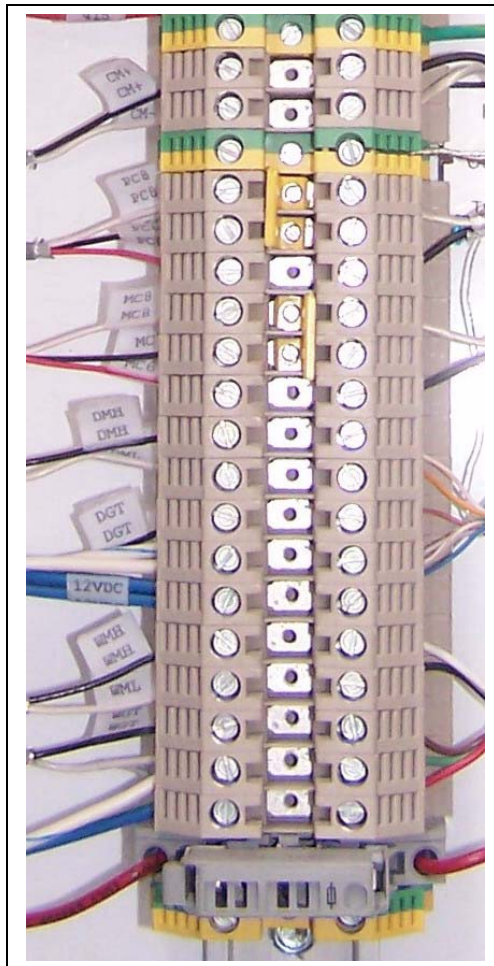
Dry sensor terminations depicted: (20/5 Line shielded cable)

- a. White with blue strip and white with brown strip. Twisted, soldered, "OVDC (12V-) at terminal strip".
- b. Brown. Dry grain temperature or DGTAT terminal strip.
- c. Blue. 12 VDC (12V+) at terminal strip.
- d. White with orange strip. Dry moisture high or DMH at terminal strip.
- e. Orange. Dry moisture low or DML at terminal strip.
- f. Shields are always grounded at green/yellow term locations.

Wet sensor terminations depicted: (Another style 5 line)

- a. White. Wet moisture high or WMH at terminal strip.
- b. Black. Wet moisture low or WML at terminal strip.
- c. Brown. Wet grain temp or WGT at terminal strip.
- d. Green: OVDC (12V+) at terminal strip.
- e. Red. 12 VDC (12V+) at terminal strip.

**NOTE:** *No shielding wires at wet sensor connections.*



**Figure 10U** *Both styles wiring depicted in terminal.*





**Figure 10V** *Moisture Sensor Power Supply and Terminal Strip Locations*

2 Amp fused power supply for 12 VDC sensor systems at tower dryer panel.



**Figure 10W** *Wet Moisture Sensor Housing*

Installations are at top heat section of tower dryer. In the second solid stainless steel sheet down from the roofs eave.



**Figure 10X** *Thumb Screw*



**Figure 10Y**

## 10. Sensors

- Thumb screw and hardware are included to simplify installations.
- **NOTE:** *Attach sensor housing to stainless sheets with provided stainless steel nuts and bolts.*
- When drilling stainless steel remember, a 1/4" sharp pilot bit, a 3/8" sharp drill bit, slow drill speeds and a lot of pressure helps.



**Figure 10Z** *Tower Dryer Roof Sections with Bindicators and Wet Sensor Housing Mounted*

Bindicators could be wired to the Junctions box at this time. (First section of dryer erections.)  
(See Page 128.)



**Figure 10AA** *Dry Sensor Installations at GSI Tower Dryer*



**Figure 10AB** *Dry Sensor Installations at Zimmerman Tower Dryer*

**NOTE:** Upon install, verify ease of access of the housing assembly for inspect at sensor and sample port.

## Dry Moisture Sensor Housing Assembly



Figure 10AC Dry Moisture Sensor Housing Assembly

## Universal Fit Dry Sensor Housing



Figure 10AD Grain Moisture Mounting Location



Figure 10AE Sample Port (180° of Mounting Location)

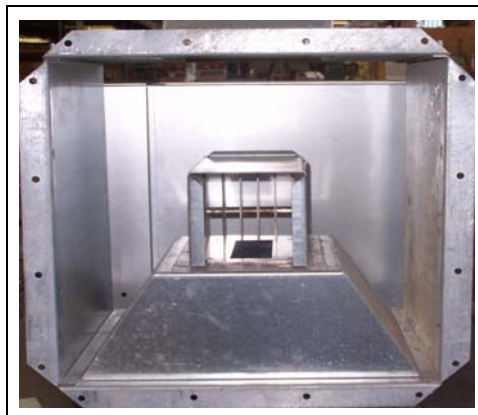


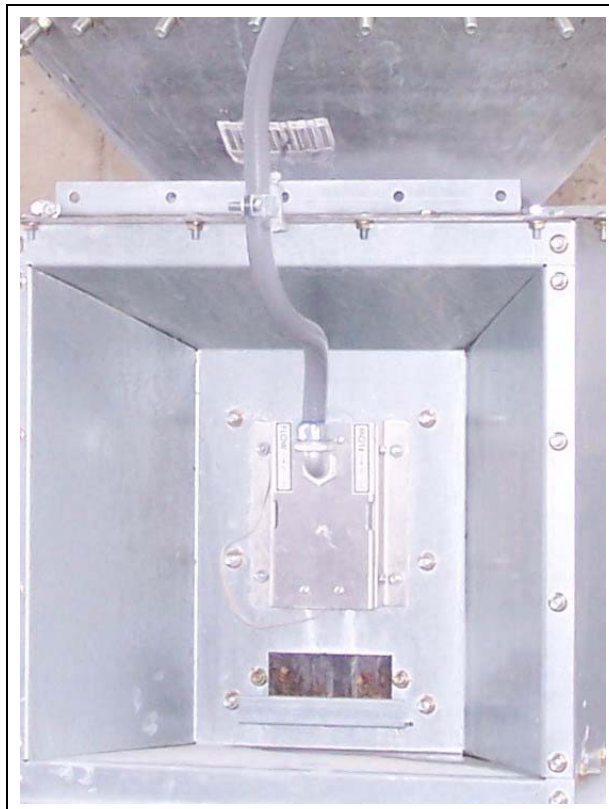
Figure 10AF Sensor/sample basket area with cleaning grill installed. (Grain discharge side.)



**Figure 10AG** Sensor basket with gate and grills installed.

**NOTE:** Restriction gates are provided for adjustment at grain flow through sensor mounting basket. The grills are provided to keep any larger materials from getting lodged in the sensor basket and disrupting sensor performance.

### **Dryer Moisture Sensor Assembly Completed with Dry Sensor Installed**

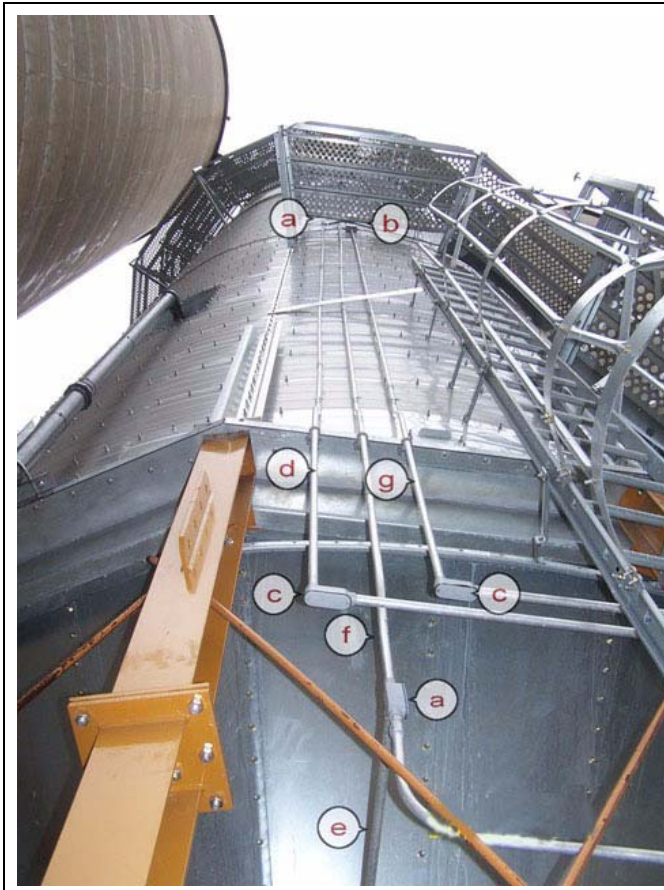


**Figure 10AH** GSI Tower Dryer



**Figure 10AI** Zimmerman Tower Dryer

**NOTE:** When install is complete, seal the sensor housing assembly. Inspect all equipment attached, is secured for tight with applicable safety stickers in place. (Secure all four (4) gates with end user.)



- A. Conduit tee installations.
- B. Outside bottom/lower high-limit/overheat.
- C. Conduit LB installations.
- D. Top/bottom bindicators and grain temperature RTD sensor conduit.
- E. Dry moisture sensor conduit.
- F. Wet moisture sensor conduit.
- G. Outside high-limit/overheat sensors.

**Figure 10AJ** Wet and Dry Moisture Sensor Conduits



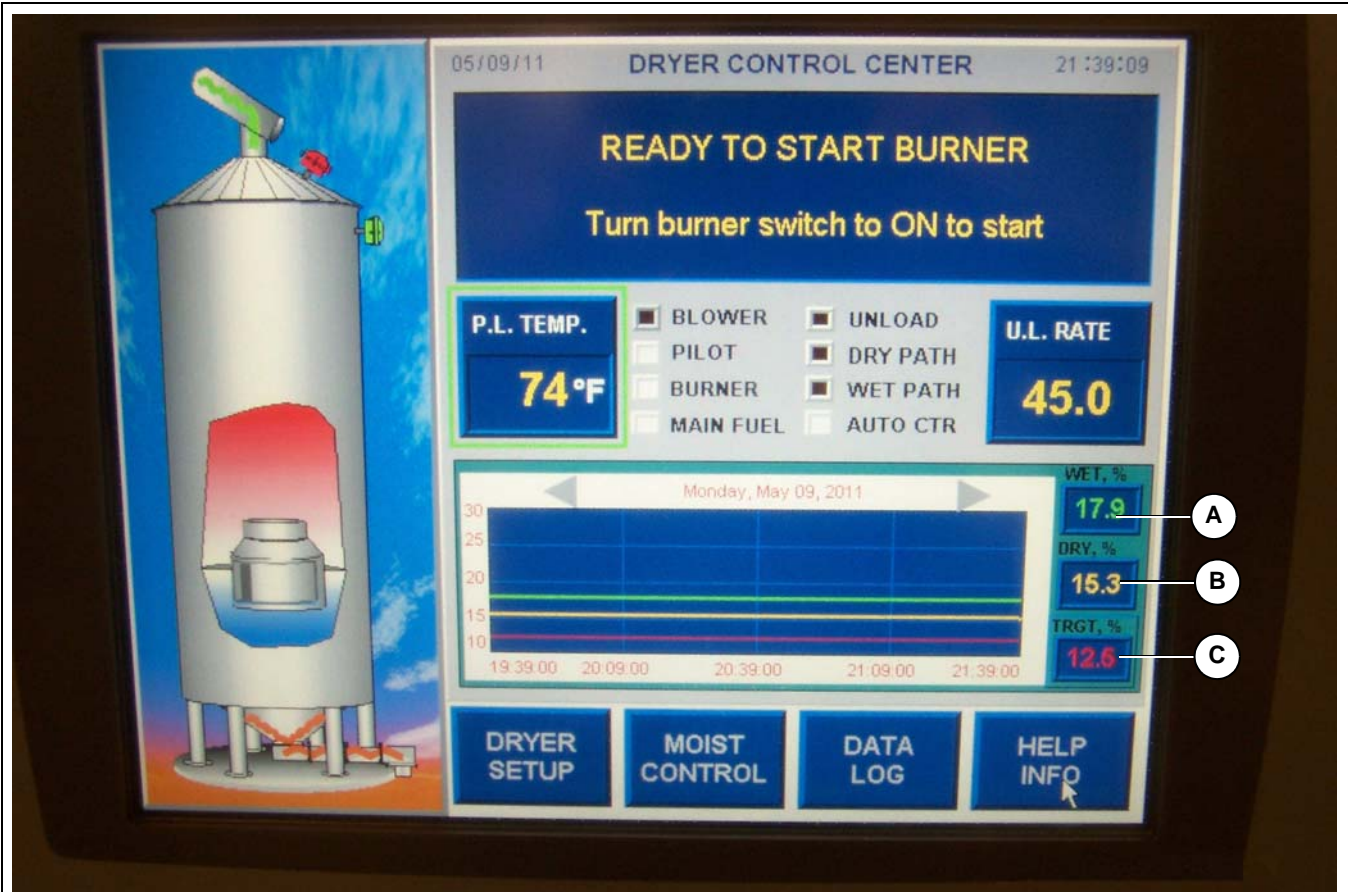
Figure 10AK Wet/Dry Sensor Package



Figure 10AL Sample Port Lid Warning Label

## 10. Sensors

### Dryer Control Center's Virtual Touch Screen Operations Display



- A. Wet moisture sensor located at the top of the tower dryer. Depicted in Green.
- B. Dry moisture sensor located at the bottom of the tower dryer. Depicted in Yellow.
- C. Target moisture percentage and touch screen set point location. Depicted in Red.
  1. Touching the display at this point will produce a number key pad for adjustments.
  2. A graph is also displayed in color.

**Figure 10AM** Sensor basket with gate and grills installed.

**NOTE:** Graph may assist in predicting possible swings in percentages.

**NOTE:** The tower dryer's wet and dry moisture sensors must be calibrated to verify (%) percentages to be accurate.





**Important Safety Precaution:**

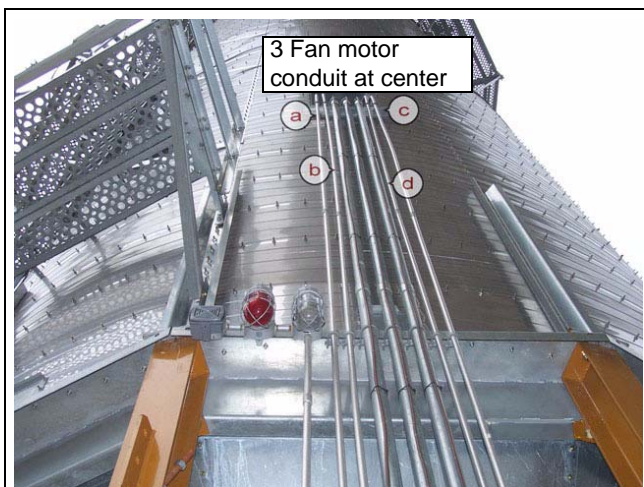
**All electrical installations must be made by qualified personnel.**

See appendices [on Pages 113-125](#) for wiring notes and schematics, etc. (See [Pages 120 and 121.](#))

1. Locate burner pilot section for ignitor and flame sensor installation.

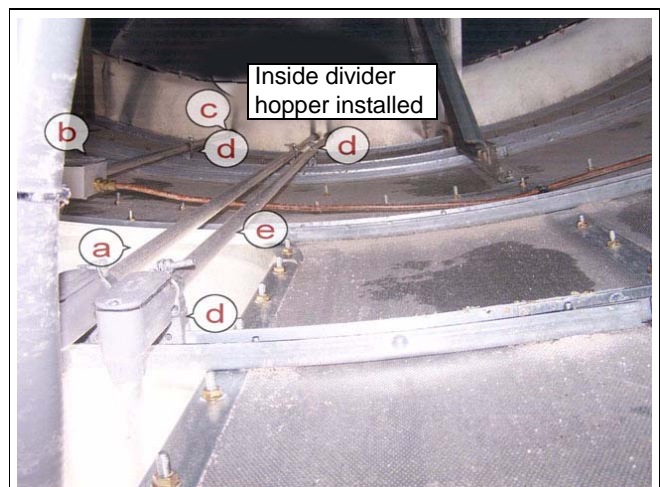
**NOTE:** Run one conduit for ignitor. Run separate and parallel conduit for flame sensor.

- a. Determine where ignition cable exits power box and knock out hole for 1/2" conduit. Install myers hub.
  - b. Determine where #14 wire (THW or THHN) for flame sensor exits power box and knock out opening for 1/2" conduit. Install myers hub.
2. Install LB-bodies for ignitor and flame sensor at back of power box.
  3. Run two (2) conduits parallel with other conduits up to dryer window (usually the motor window). Bend conduits 90° and run in motor window to walk-in cooling section.
  4. Install LB-bodies and run conduits up inside of dryer to divider hopper. Stay as close as possible to inside wall of dryer. Drill through divider hopper. Run conduits up to level with bottom of burner.



- A. 7 mm Spark wire conduit.
- B. 14 Gauge and ground wire conduit.
- C. Inside high-limit/overheat and adjustable high-limit conduit.
- D. Unload device motor conduit.

**Figure 11A** Conduits for ignitor and flame sensor installed.



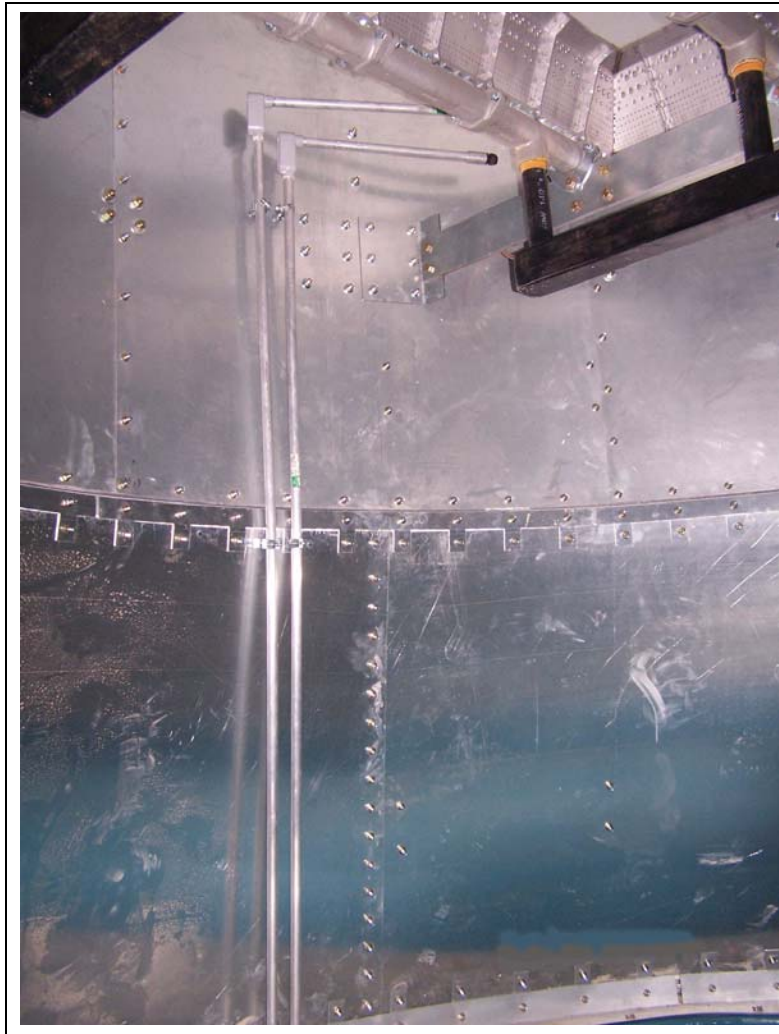
- A. 14 Gauge and ground wire conduit installed.
- B. Inside high-limit/overheat installed.
- C. Plenum RTD and adjustable high-limit capillary conduit.
- D. Mini and beam clamps used to secure all 1/2" conduits.
- E. 7 mm Spark wire conduit.

**Figure 11B** Conduits for ignitor and flame sensor installed through motor window and up through hopper divider.

5. Turn conduits 90° toward burner housing. Drill through burner housing. Extend conduit 4" through burner housing.

**NOTE:** Conduits must run within 16" of ignitor to protect ignition cable.

## 11. Ignitor and Flame Sensor



**Figure 11C** Note conduit has been extended inside burner can housing and is securely mounted to reducer and burner housing.

6. Install 1/2" appleton (liquid-tight cable connector) to each conduit.

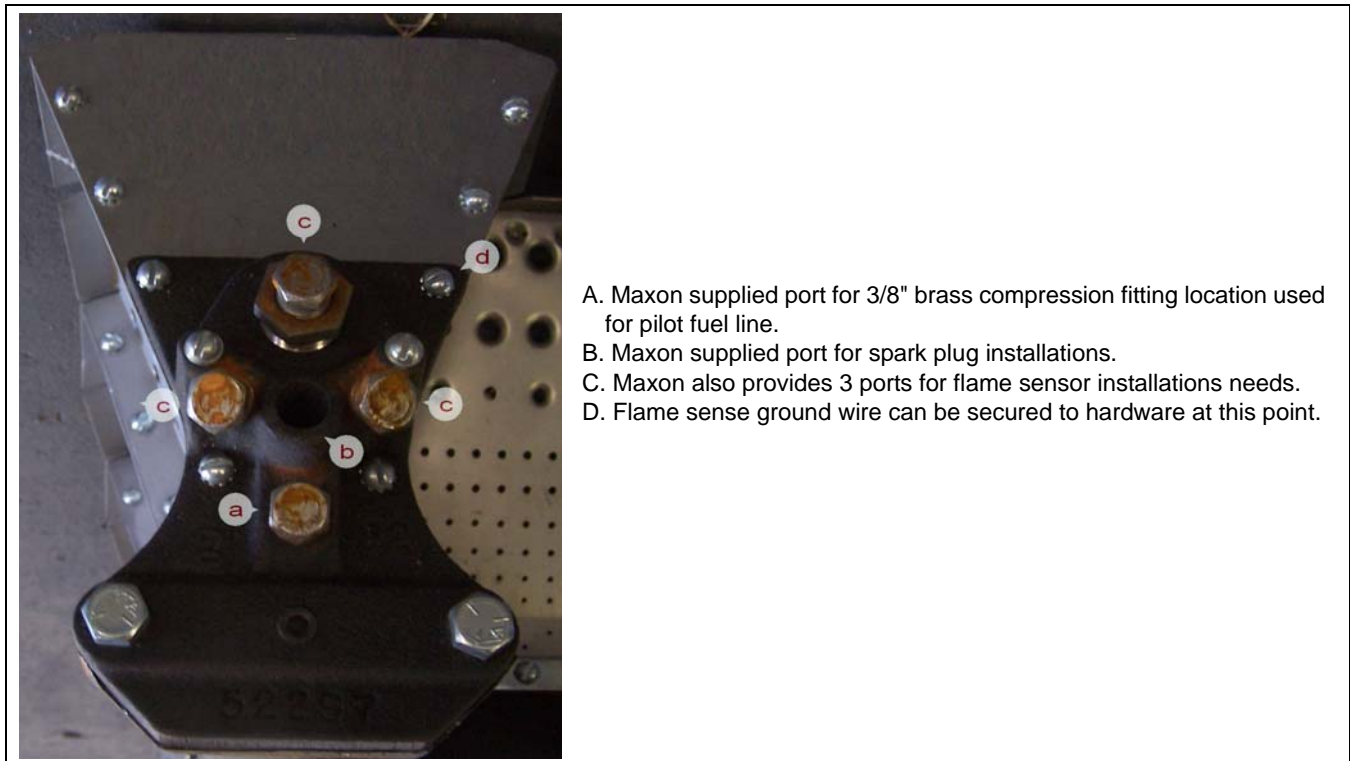


- A. Maxon burner
- B. Maxon burner ignition end plate
- C. Pilot line completed
- D. Maxon supplied spark plug installed
- E. Maxon supplied flame rectification sensor
- F. Black 1/2" heyco fittings at each conduit installed.
- G. 1/2" Conduit LB junctions installed
- H. Mini's installed and ready to be secured.
- I. 14 Gauge and ground wire for flame sensor conduit
- J. 7 mm Spark wire for spark plug conduit

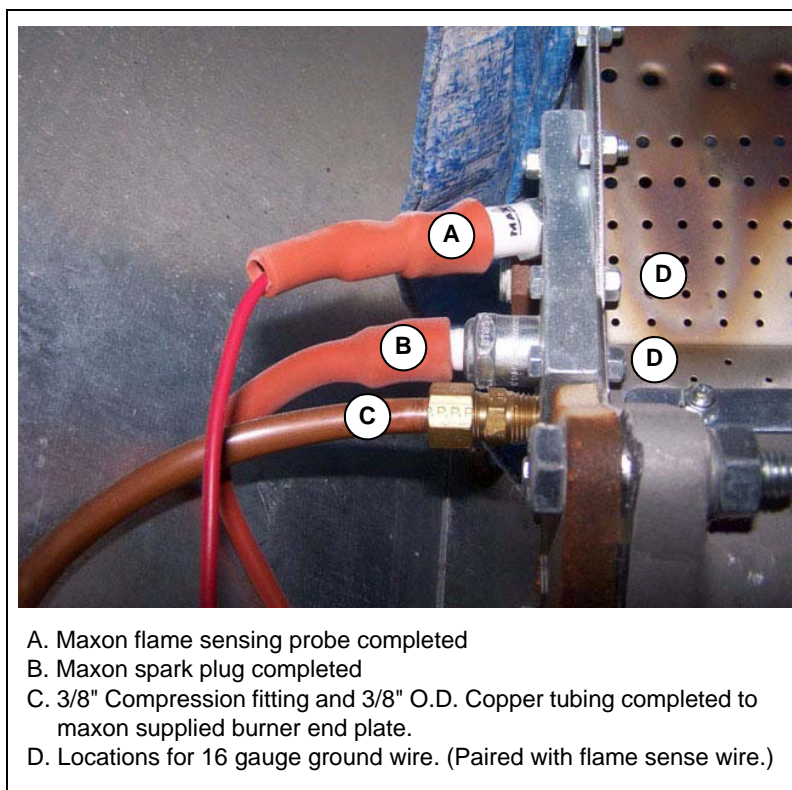
**Figure 11D**

7. Install ignitor and flame sensor (with rubber boots) to installation points on burner.

**NOTE:** Make any necessary adjustments to flame sensor after dryer start-up.



**Figure 11E** Installed to Pilot Section



**Figure 11F** Close up installed to pilot section.

## 11. Ignitor and Flame Sensor

8. Pull ignition cable to ignitor and terminate at ignition transformer in power box. (See Figure 11G on Page 92.)

Pull #14 wire red flame sensor wire and terminate at protectofier terminal E in power box. (See Figure 110 on Page 95.)

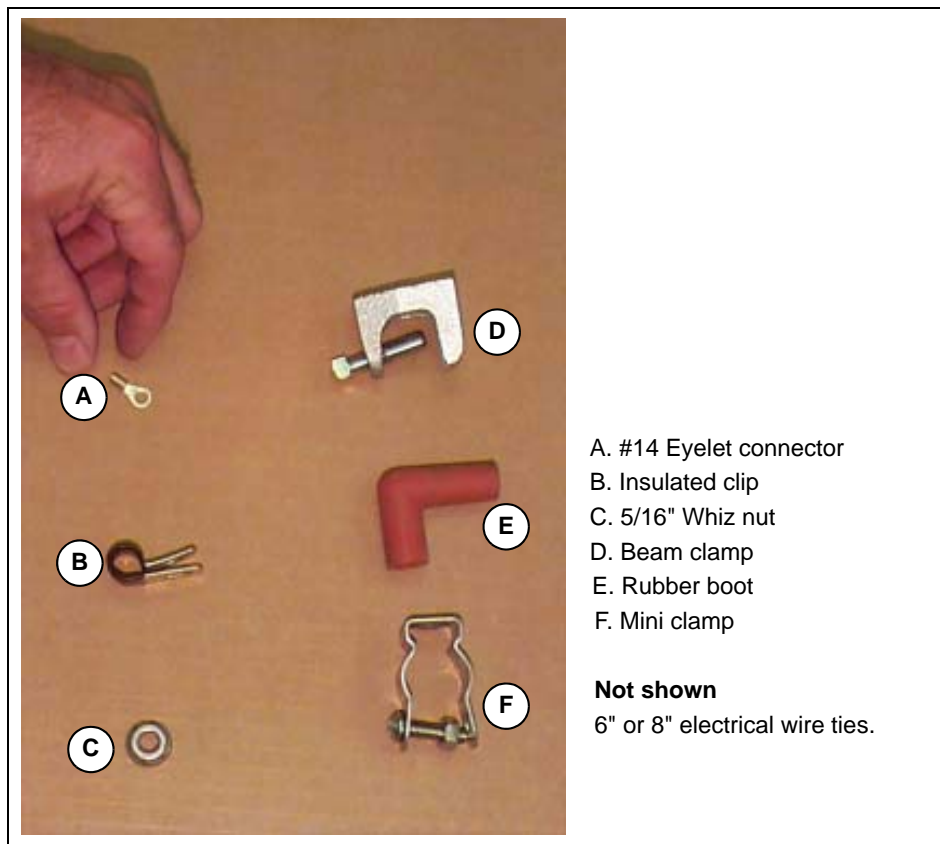


Figure 11G Hardware

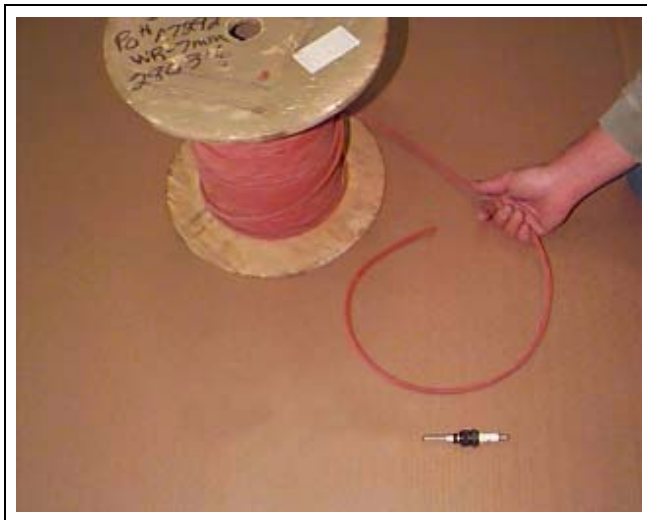


Figure 11H Ignitor and Ignition Cable

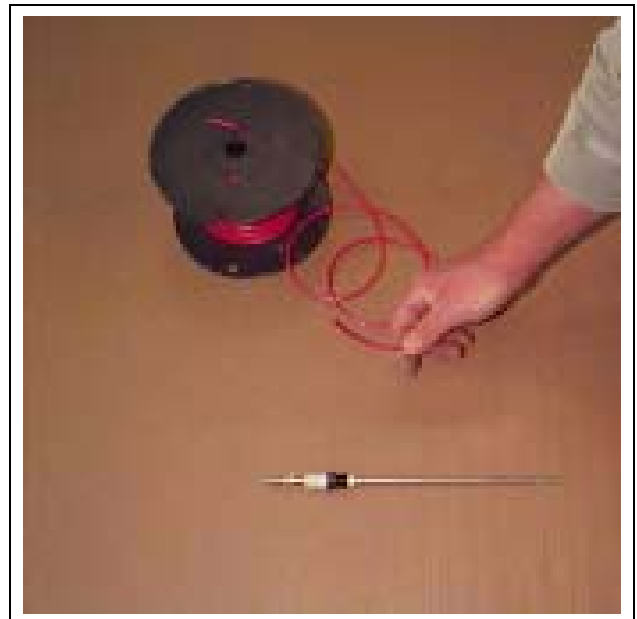


Figure 11I Flame Sensor and #14 Red Flame Sensor Wire



Figure 11J Maxon Flame Sensor



Figure 11L Insulator Boot



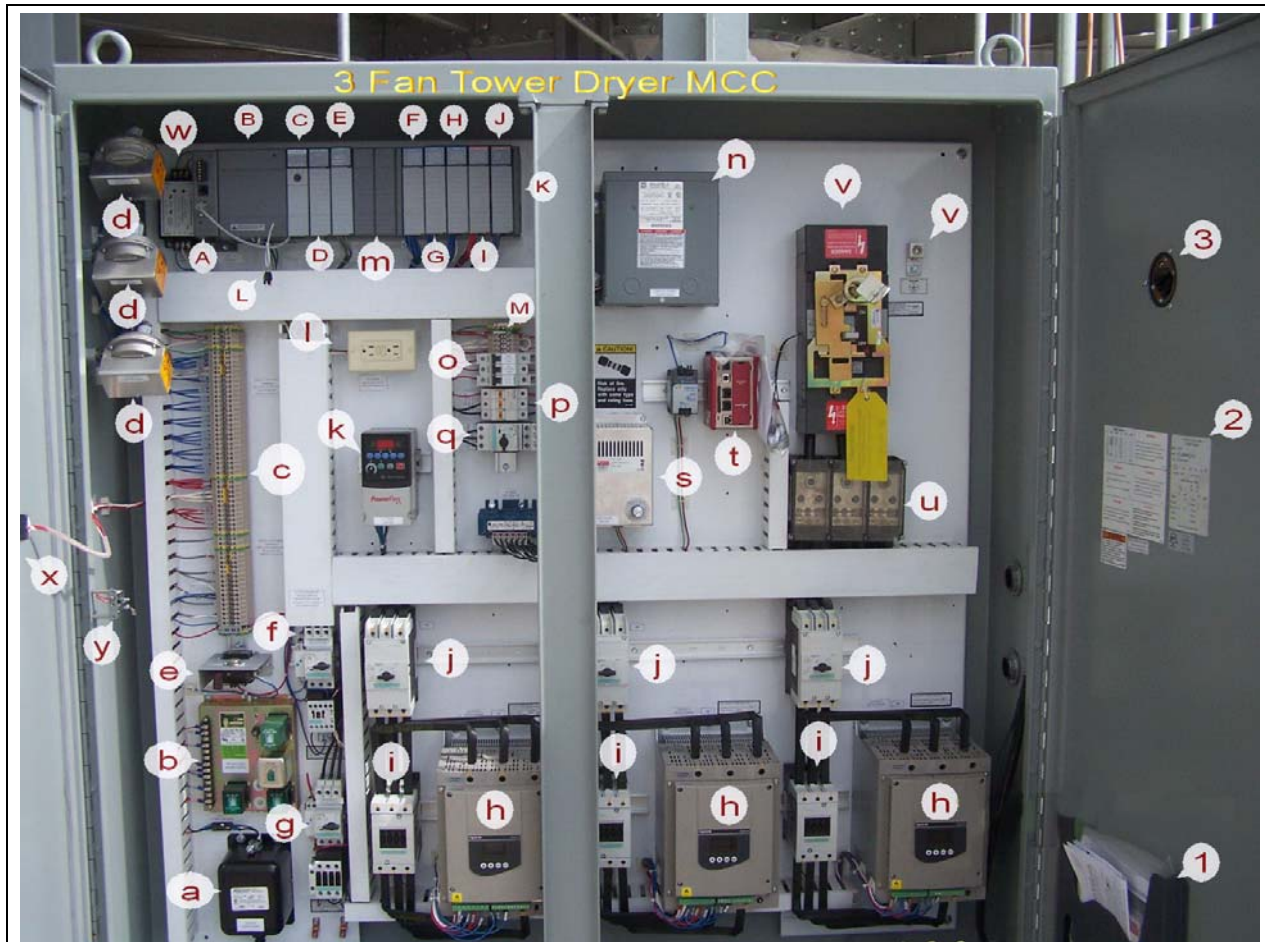
Figure 11K Maxon Spark Plug



Figure 11M Maxon "Quik" Connector

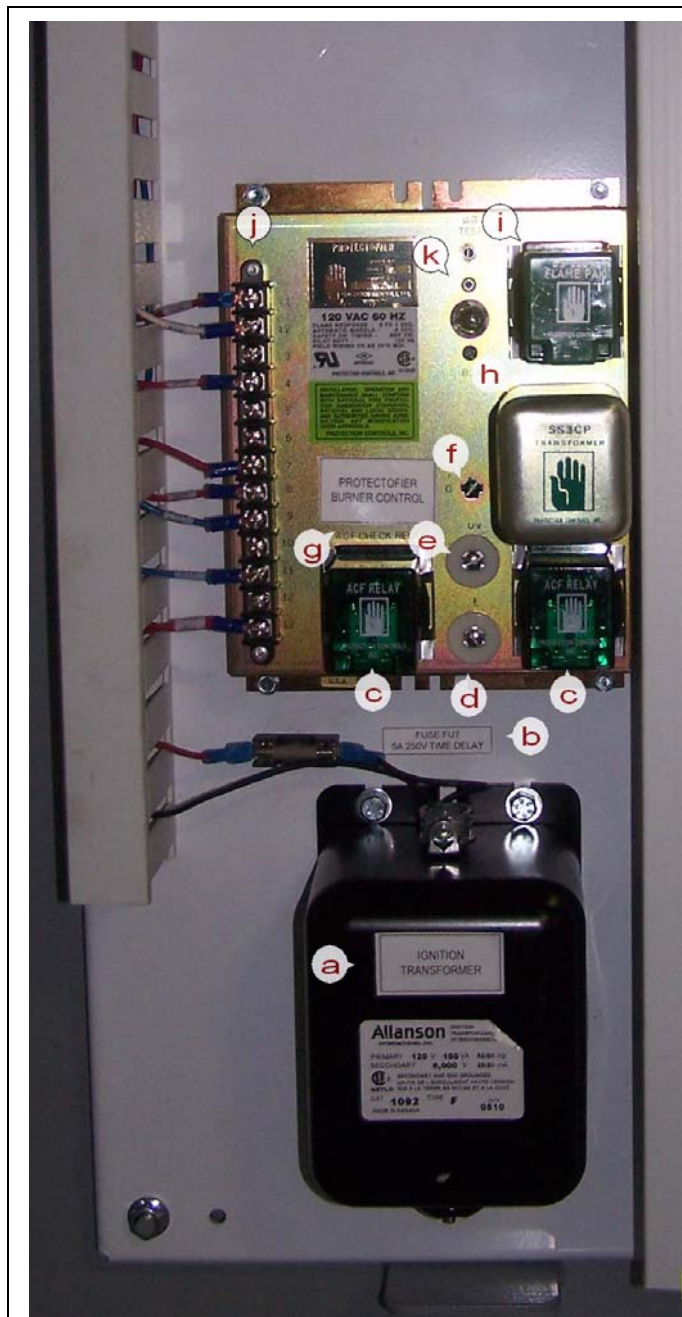
**NOTE:** "Quik" connectors and insulator boots usage is required.

## 11. Ignitor and Flame Sensor



- |                                     |                             |
|-------------------------------------|-----------------------------|
| A. Ignition transformer             | 1. Dryer manual compartment |
| B. Protector burner control         | 2. Dryer informations       |
| C. Terminal strip                   | 3. Main disconnect assembly |
| D. Air pressure switches            |                             |
| E. 15V MC power supply              |                             |
| F. Dry conveyor starter/contactor   |                             |
| G. Wet conveyor starter/contactor   |                             |
| H. Fan/blower soft starts           |                             |
| I. Fan/blower contactors            |                             |
| J. Fan/blower starter-breaker       |                             |
| K. Toshiba inverter                 |                             |
| L. 120V 6 Amp receptical            |                             |
| M. Main PLC components              |                             |
| N. Control voltage transformer      |                             |
| O. Control power breakers           |                             |
| P. Control power fuses block        |                             |
| Q. Unload motor starter             |                             |
| R. In-line reactor                  |                             |
| S. Block heater                     |                             |
| T. WatchDog and power supply system |                             |
| U. Main power distribution block    |                             |
| V. Main disconnect/ground lug       |                             |
| W. In-line filter                   |                             |
| X. Main panel emergency stop        |                             |
| Y. Door safety switch               |                             |

Figure 11N Ignitor Wires to Ignition Transformer



- A. Ignitions transformer.
- B. 5 Amp time.
- C. ACF Relay.
- D. Terminal screw, use this for point of terminations for the maxon flame sensing probe.
- E. UV Terminations screw for oil fired maxon burner ultra violet eye sensor.
- F. Terminations screw, all grounds come back to this point.
- G. Protectofier burner controls (high light this one.)
- H. Control transformer for flame sense.
- I. Flame pack relay.
- J. Tamper proof terminations screws.
- K. Proof/on light and testing port.

**Figure 11O** Flame sensor wires to protectofier terminal E.

## 12. Fuel Train



**Important Safety Precaution:**  
*All electrical installations must be made by qualified personnel.*

See appendices [on Pages 113-125](#) for wiring notes and schematics, etc. (See [Pages 120 and 121.](#))

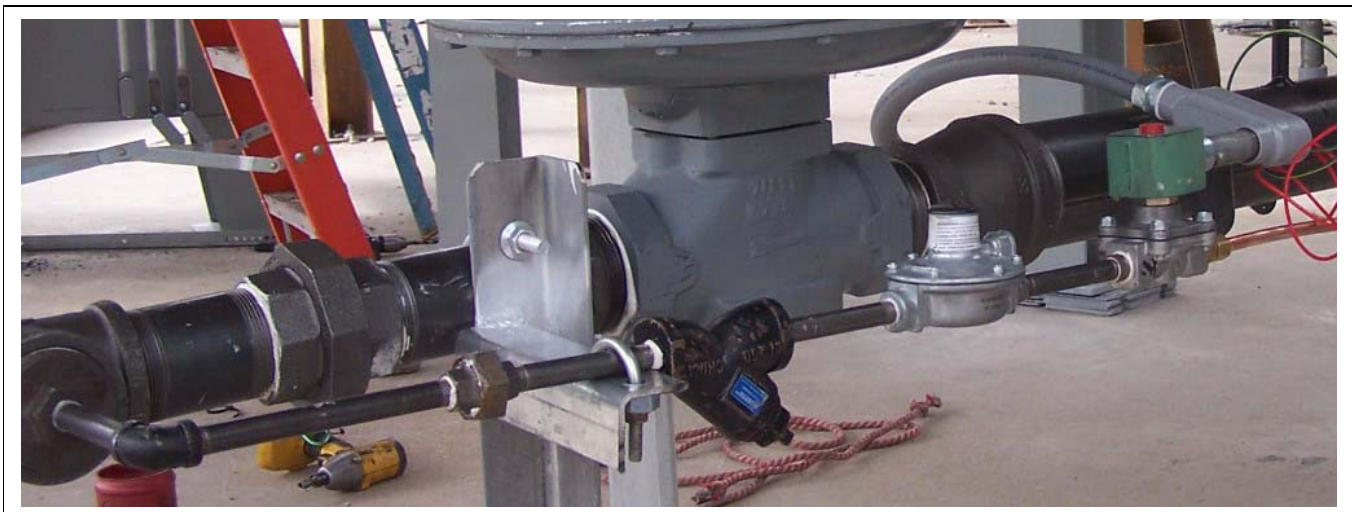
### Fuel Train Installations (Natural Gas or Liquid Propane)



- |  |  |
|--|--|
| A. Ball valve, fuel train/line drain valve | E. Pilot solenoid flex conduit                     |
| B. Modulation motor                        | F. 1/2" Conduit tee connections too maxon's        |
| C1. Upstream/primary maxon                 | G. 1 of 2 U-Bolt clamps securing fuel train        |
| C2. Downstream/secondary maxon             | H. CV 'butterfly' valve                            |
| D. Regulator                               | I. Oz. Gauge                                       |
| D1. Regulator vent                         | J. 1/2" Flex conduit to honeywell modulation motor |
| D2. Regulator relief valve                 | K. 3/8" Pilot copper fuel tubing                   |
| D3. Regulator Oz. gauge                    |  |

**Figure 12A** Fuel Train

All completed fuel trains, should always have a slight fall towards the brass drain shut off valve (call out "A"). Verify with level at maxon shut off valves before mounting is completed.



**Figure 12B** Domestic Pilot Line



## Fuel Train - Demonstration Close Ups

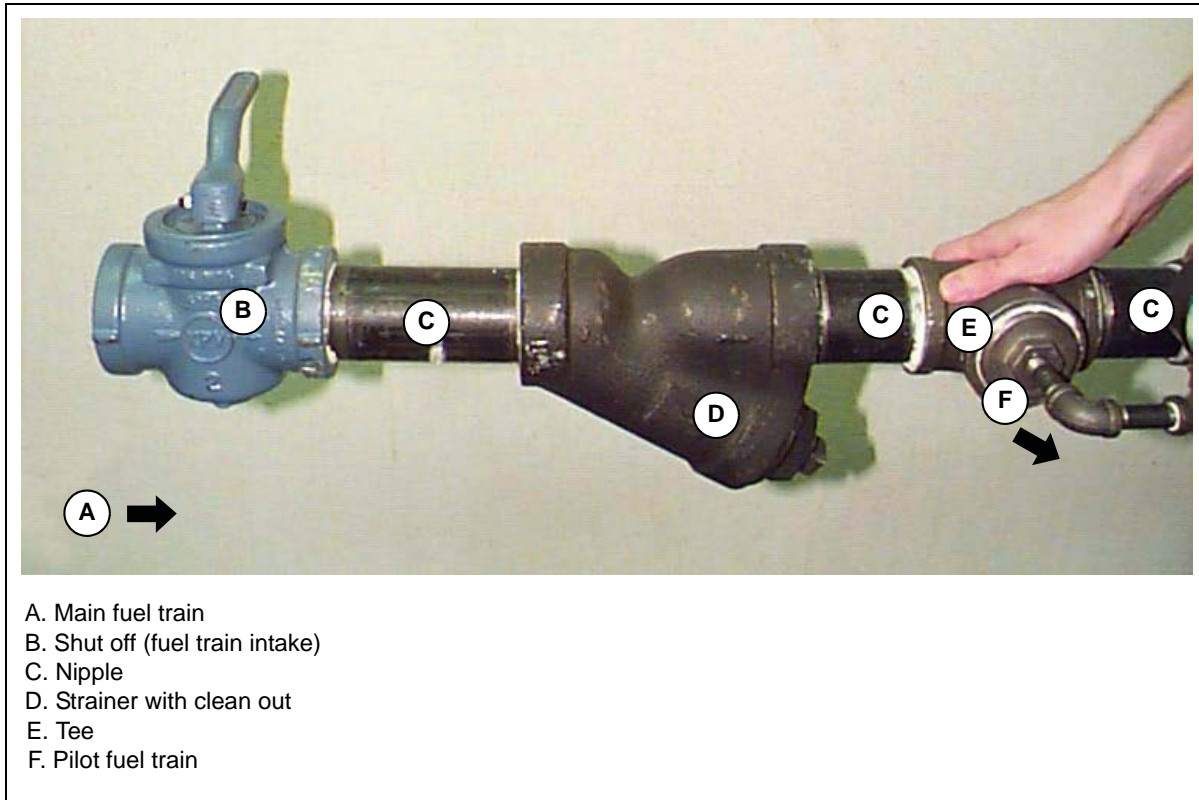


Figure 12C

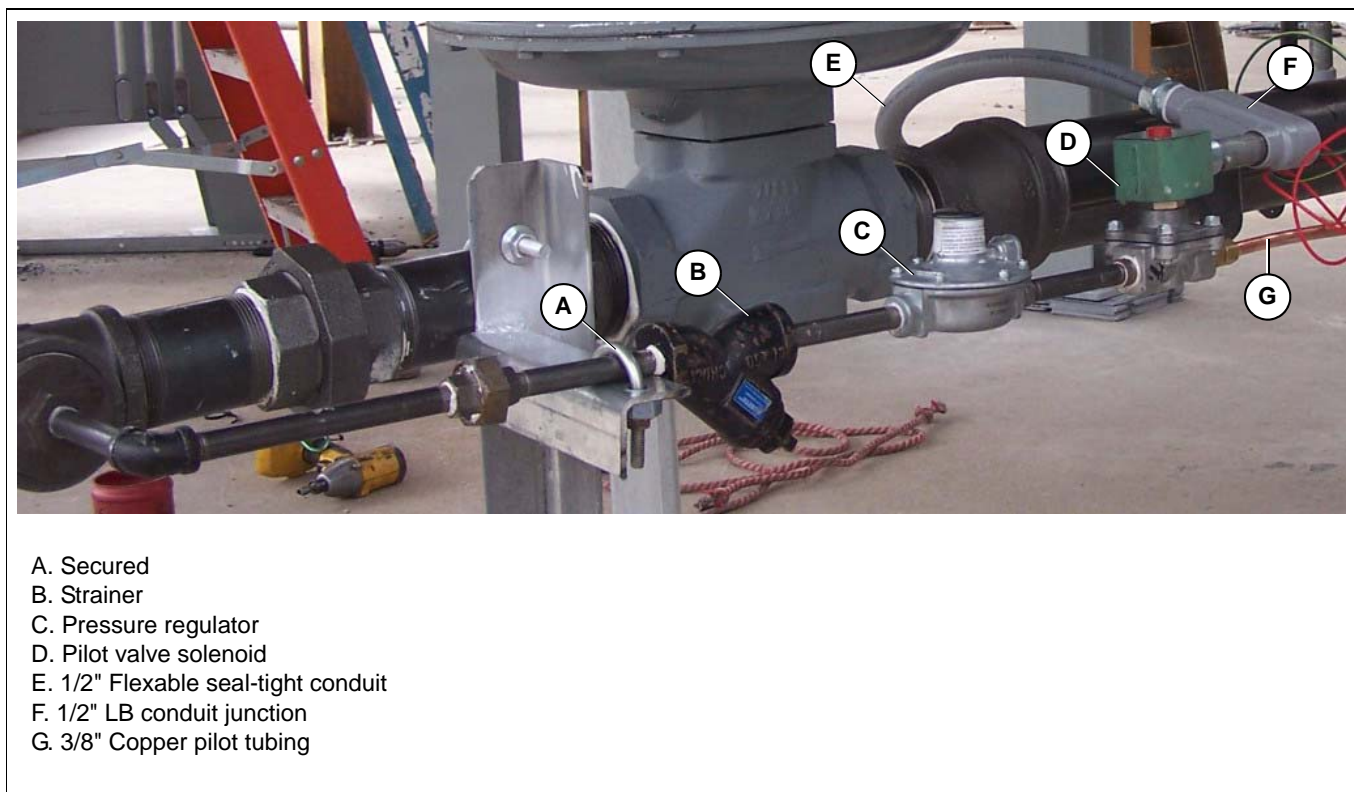
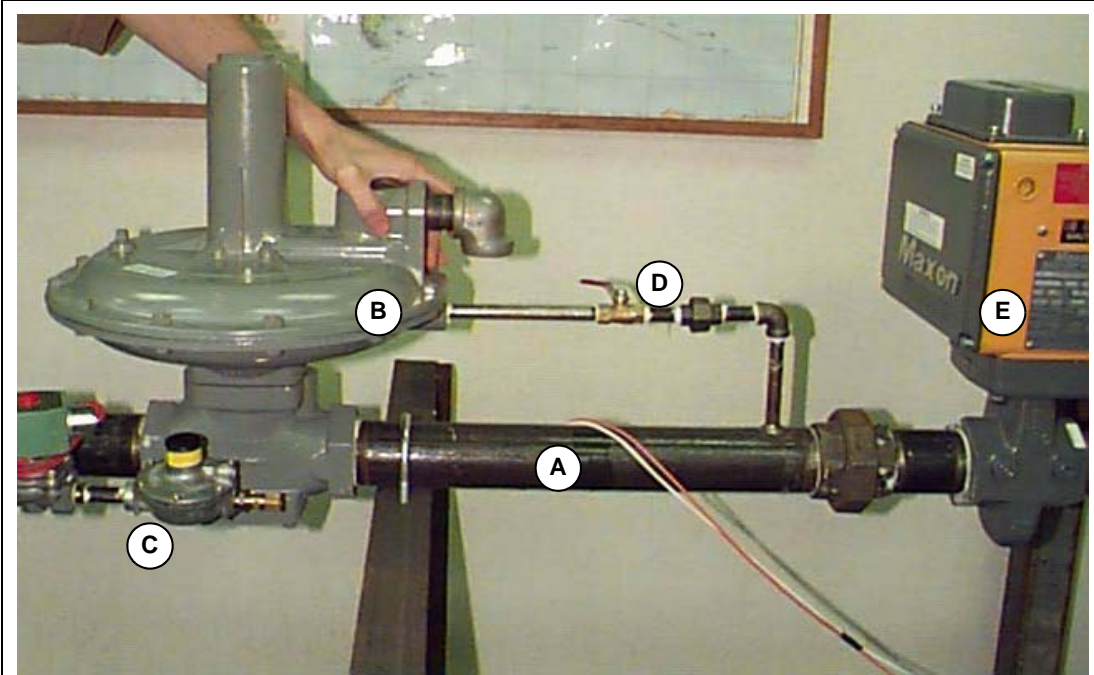


Figure 12D

Fuel Train - Demonstration Close Ups (Continued)



- A. Main fuel train
- B. Main regulator
- C. Solenoid regulator on pilot fuel train
- D. Downstream control valve
- E. Maxon

Figure 12E



- A. Primary maxon (closest to fuel intake)
- B. Secondary maxon (downstream from primary maxon)

Figure 12F

Fuel Train - Demonstration Close Ups (Continued)

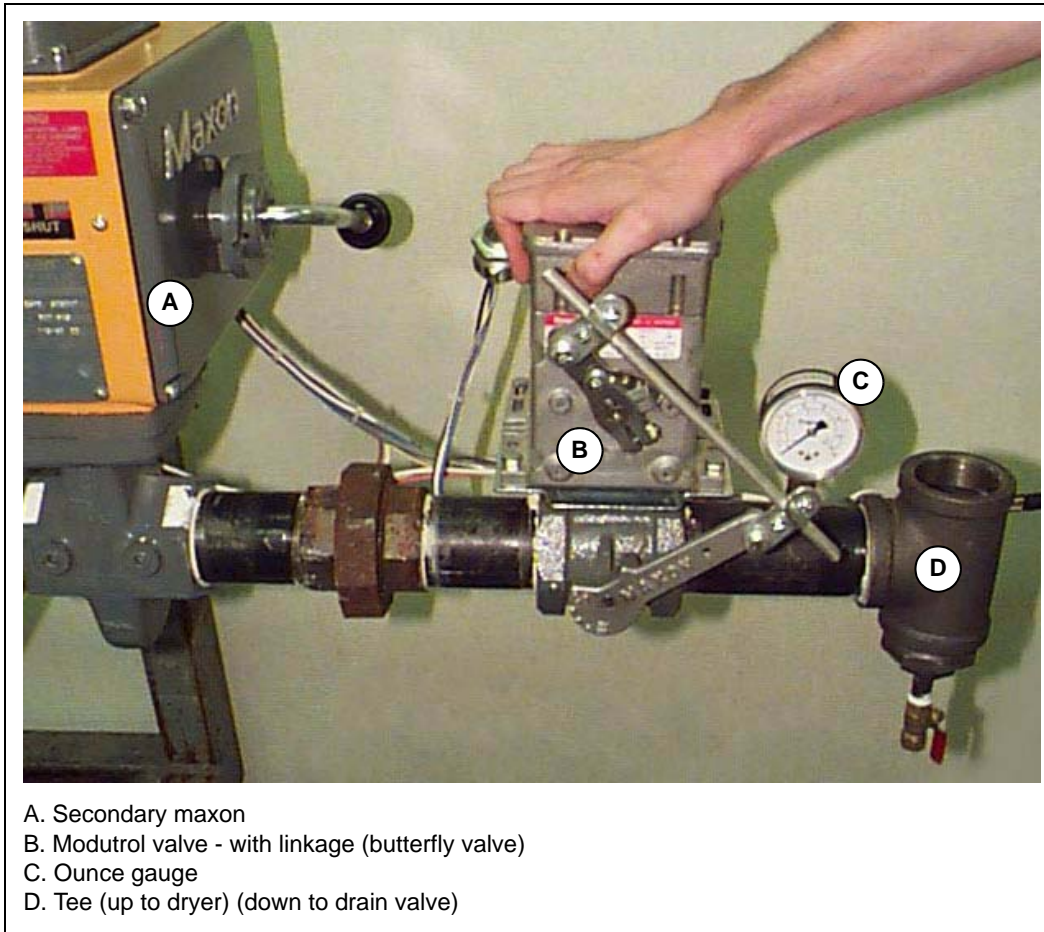


Figure 12G

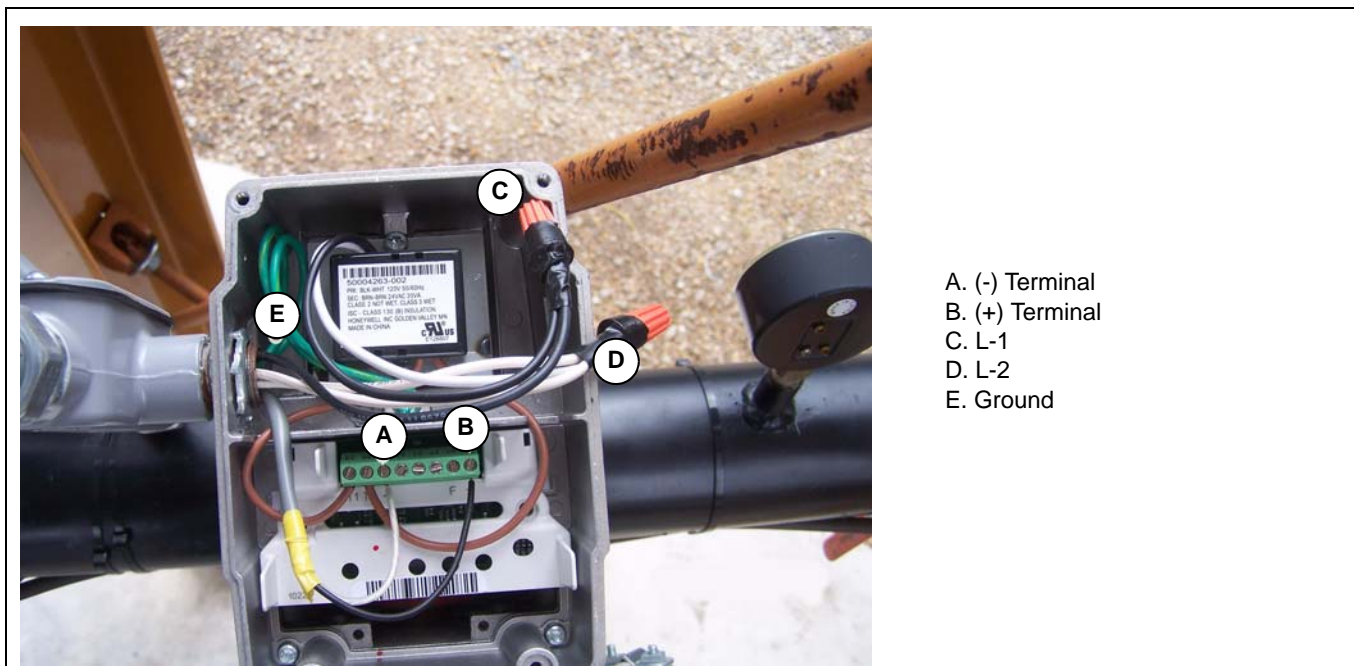


Figure 12H

### Fuel Train - Demonstration Close Ups (Continued)



**Figure 12I**

**NOTE:** *This shut off ball valve should always be open when dryer is its shut down state.*

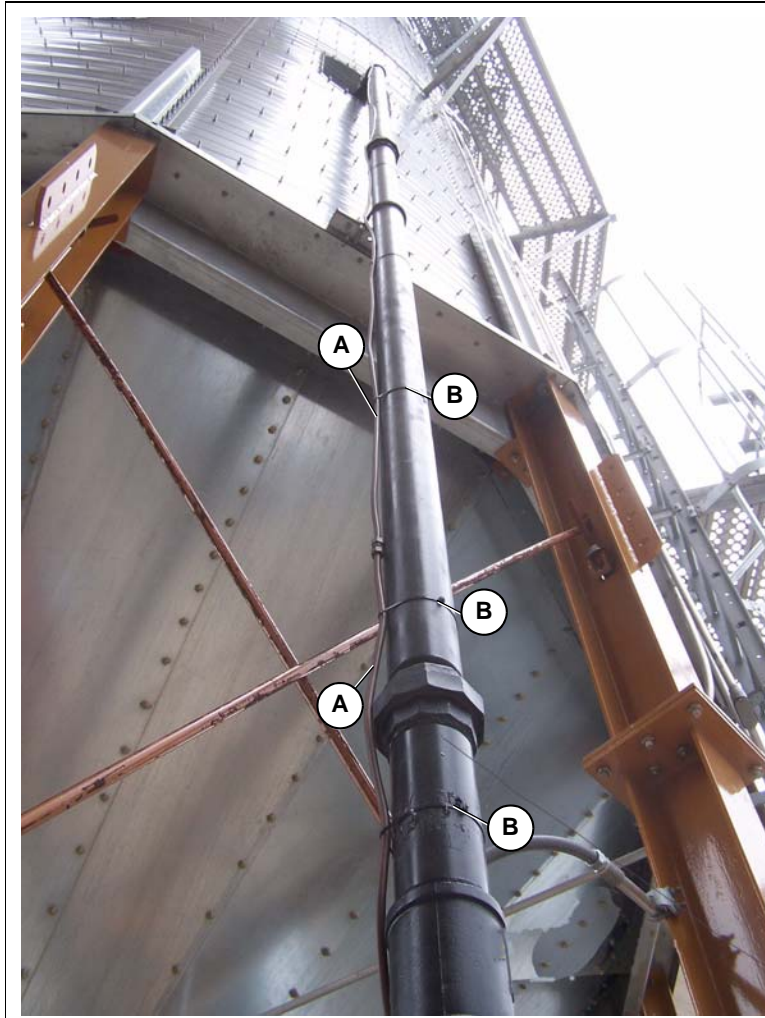
### Pilot Fuel Line

**NOTE:** *3/8" Copper tubing used for pilot fuel line is same tubing used for air switches.*

1. Connect pilot fuel line to 3/8" brass compression fitting on pilot fuel train. *(See Figure 12G.)*
2. Run 3/8" copper pilot fuel line up along fuel piping and through dryer window above fuel train. *(See Figure 12C on Page 97.)*
3. Drill 1/2" hole (beside fuel piping) through blower splice plate (burner floor). *(See Figure 12E on Page 98.)*
4. Run pilot fuel line up to connecting point on burner pilot section (wire tie to burner manifold). *(See Figure 12F on Page 98.)*
5. Connect pilot fuel line to connecting point on burner pilot section with 3/8" brass compression fitting. *(See Figure 12F on Page 98.)*

**NOTE:** *Wire tie pilot fuel line along fuel piping inside and outside of dryer.*

## Pilot Fuel Line (Continued)



- A. 3/8" Pilot fuel copper tubing
- B. Secured regularly to 4" fuel line with weather resistance wire ties.

**Figure 12J** Completed 3/8" copper pilot tubing and 4" natural gas pipe. All attached securely and fresh paint complete a tower dryer fuel train.



**Figure 12K** Pilot copper tubing continuing inside dryers cooling section and up through the fan/blowers to the terminations point in the burner. **NOTE:** Notice un-painted pipe line.

Pilot Fuel Line (Continued)

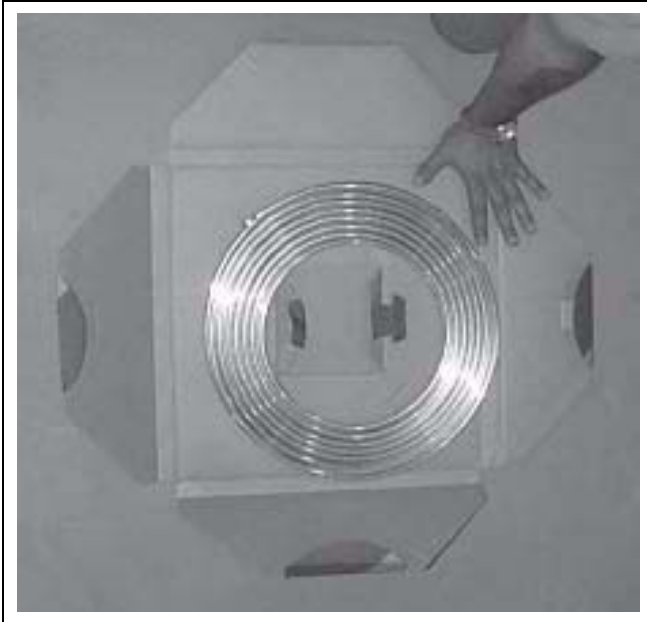


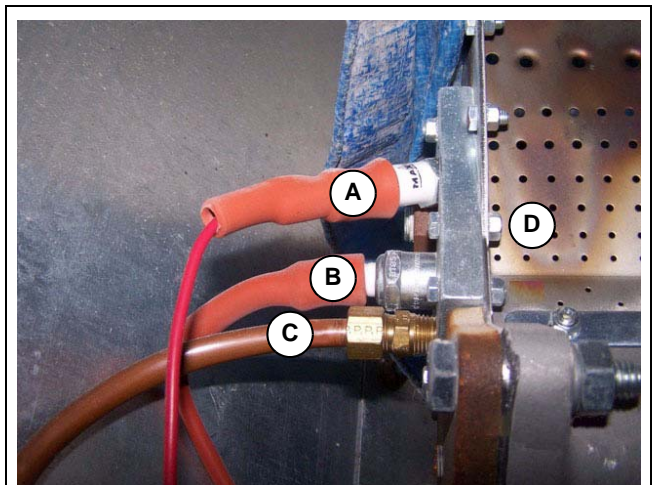
Figure 12L



Figure 12M Running 3/8" pilot fuel line up along burner manifold to connecting point in burner pilot section. Wire tie.



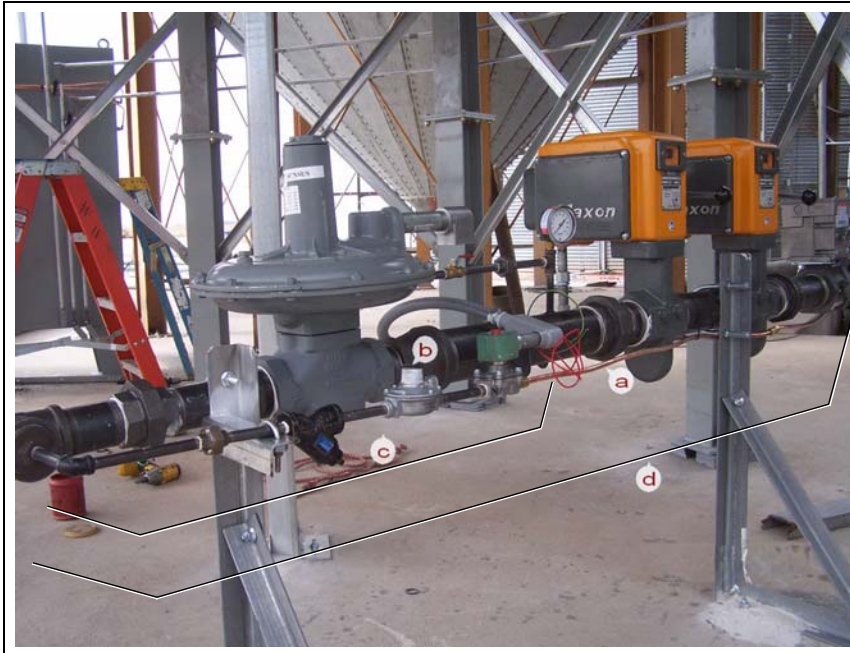
Figure 12N 3/8" Compression fitting completed from maxon pilot port continuing at 3/8" pilot fuel.



- A. Maxon flame sensing probe.
- B. Maxon spark plug.
- C. 3/8" Pilot fuel tubing.
- D. Ground wire connections points.

Figure 12O Pilot fuel line installed to connecting point on burner pilot section.

## Pilot Fuel Line (Continued)



- A. 3/8" Pilot copper tubing.
- B. Pilot line strainer, regulator, pilot solenoid.
- C. Pilot section.
- D. 4" Fuel train sections.

**NOTE:** Line has been secured with a 1/2" U-bolt.

Figure 12P

## Fuel Train Wiring

Use one 1/2" conduit for pilot solenoid, maxon gas valves\* and modutrol motor ([See Figure 12J on Page 101](#)) wiring.

1. Determine where conduit for fuel train wiring exits power box and knock out hole for 1/2" conduit. Install myers hub.
2. Install LB-body at back of power box and run conduit up to top of nearest dryer leg.
3. Run conduit around dryer, attaching to each leg with 1/2" korn clamp.
4. Install 1/2" LB-body and run conduit down dryer leg closest to fuel train, then run flexible conduit to fuel train.
5. Connect conduit to pilot solenoid, maxon valves and modutrol motor.
6. Group and pull wires.

*See Appendix C Field Notes on Page 120 and 121.*



Figure 12Q Modutrol motor, cover and cover hardware supplied as shipped.

## Example - Installing Conduit for Fuel Train Wiring



**Figure 12R** *Leveling Conduit*



**Figure 12T** *Putting korn clamp on conduit.*



**Figure 12S** *Running Flexible Conduit*

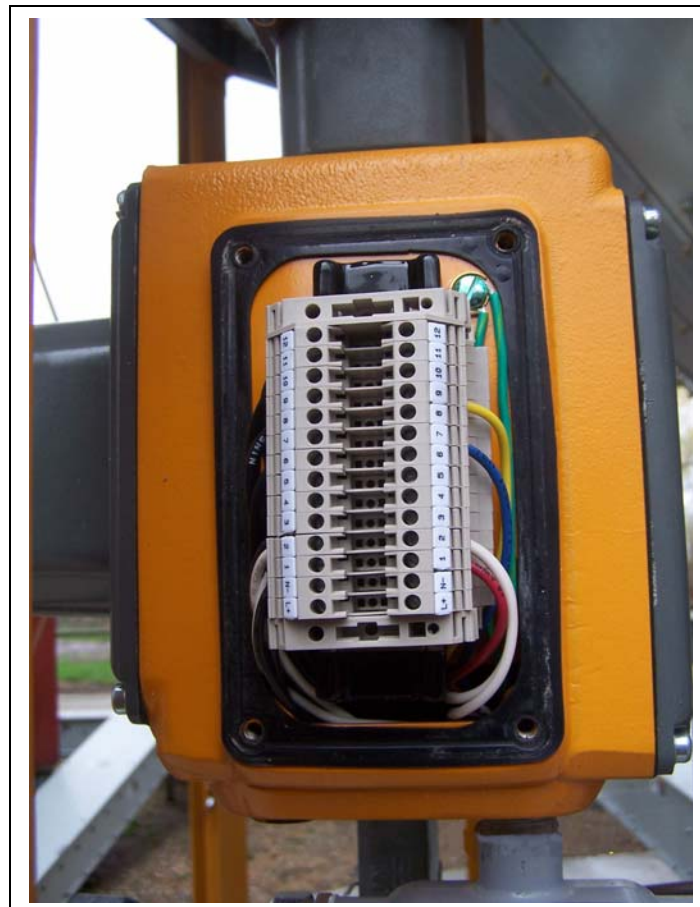


**Figure 12U** *1/2" Fuel and Pilot Conduit Installed*



**Example - Wiring Fuel Train**

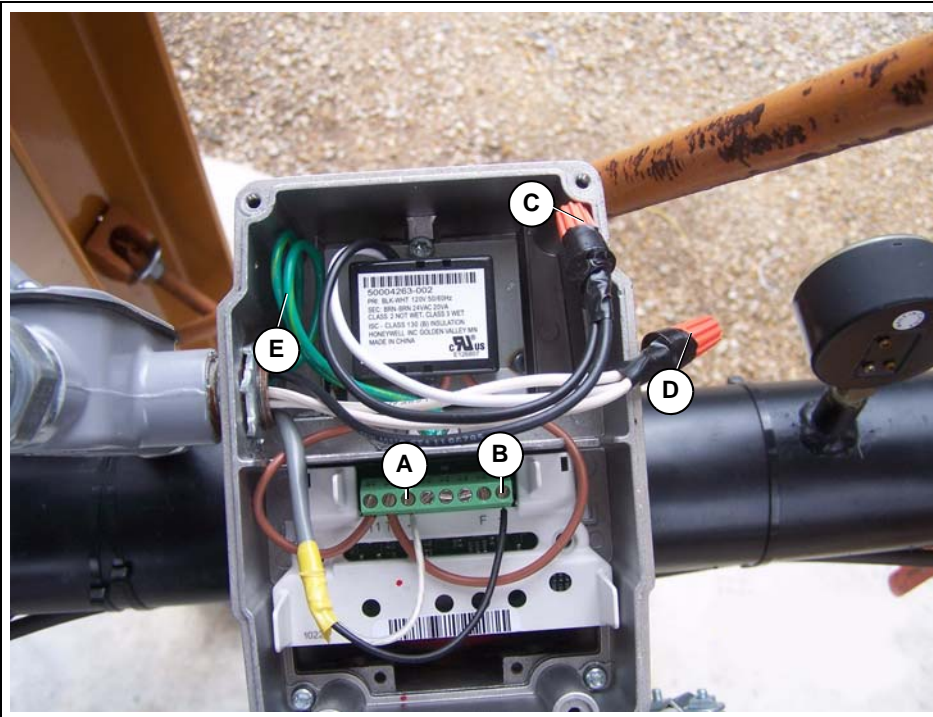
**Figure 12V** *Standard Wiring for Primary/Upstream Electronically Controlled Maxon*



**Figure 12W** *Standard Wiring for Secondary/Downstream Electronically Controlled Maxon*

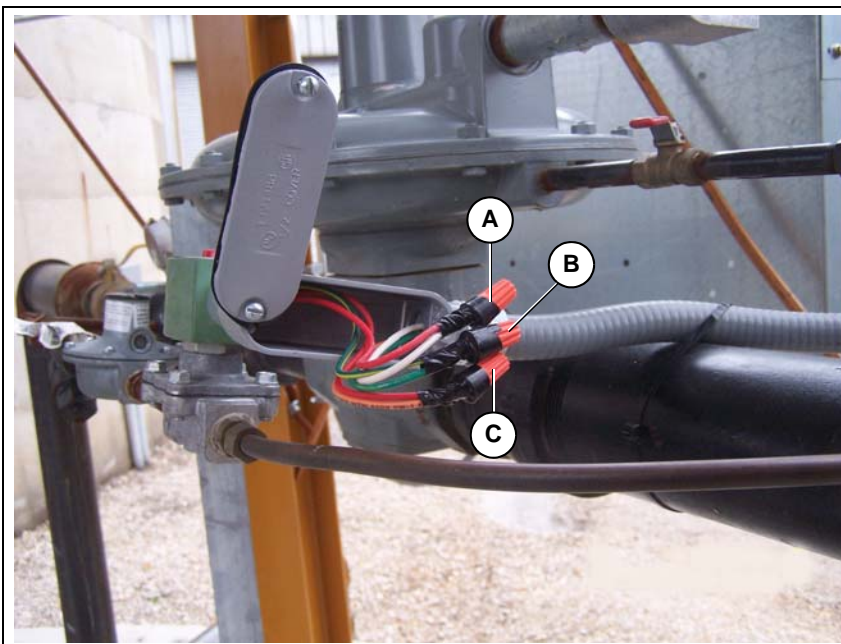
## 12. Fuel Train

### Example - Wiring Fuel Train (Continued)



- A. 4-20 (-) negative = White at shielded.
- B. 4-20 (+) Positive = Black at shielded.
- C. 16 Gauge L-1 = Black.
- D. 16 Gauge L-2 = White.
- E. 18 Gauge ground = Green with yellow strip.

Figure 12X Wiring Modutrol Motor



- A. From valve = Red too white = L-2
- B. Grounds will be tied together
- C. From valve = Red too orange = 505

Figure 12Y 120V Pilot Solenoid Valve Wiring

**Example - Wiring Fuel Train (Continued)**



**Figure 12Z** *Attaching seal-tight to conduit tee on maxon valve.*



**Figure 12AA** *Cutting Seal-Tight*



**Figure 12AB** *Attaching Seal-Tight Fitting to Seal-Tight*

Example - Wiring Fuel Train (Continued)



Figure 12AC Fuel Piping and Pilot Fuel Piping



Figure 12AD Fuel Train on 2000 BPH Dryer.

**Example - Wiring Fuel Train (Continued)**

**Figure 12AE** *Standard Pilot and Fuel Trains Securely Mounted*



**Figure 12AF** *3/8" Pilot Copper Tubing Secured to Fuel Train*



**Figure 12AG** *Pilot fuel train installations almost completed.*

## 12. Fuel Train

### Example - Wiring Fuel Train (Dryer Shown After Operation) (Continued)



**Figure 12AH** *3/8" Pilot fuel copper tubing up through center of 3 fan dryer.*



**Figure 12AI** *Pilot fuel train piping and fuel piping runs up through divider hopper.*



**Important Safety Precaution:**  
*All electrical installations must be made by qualified personnel.*

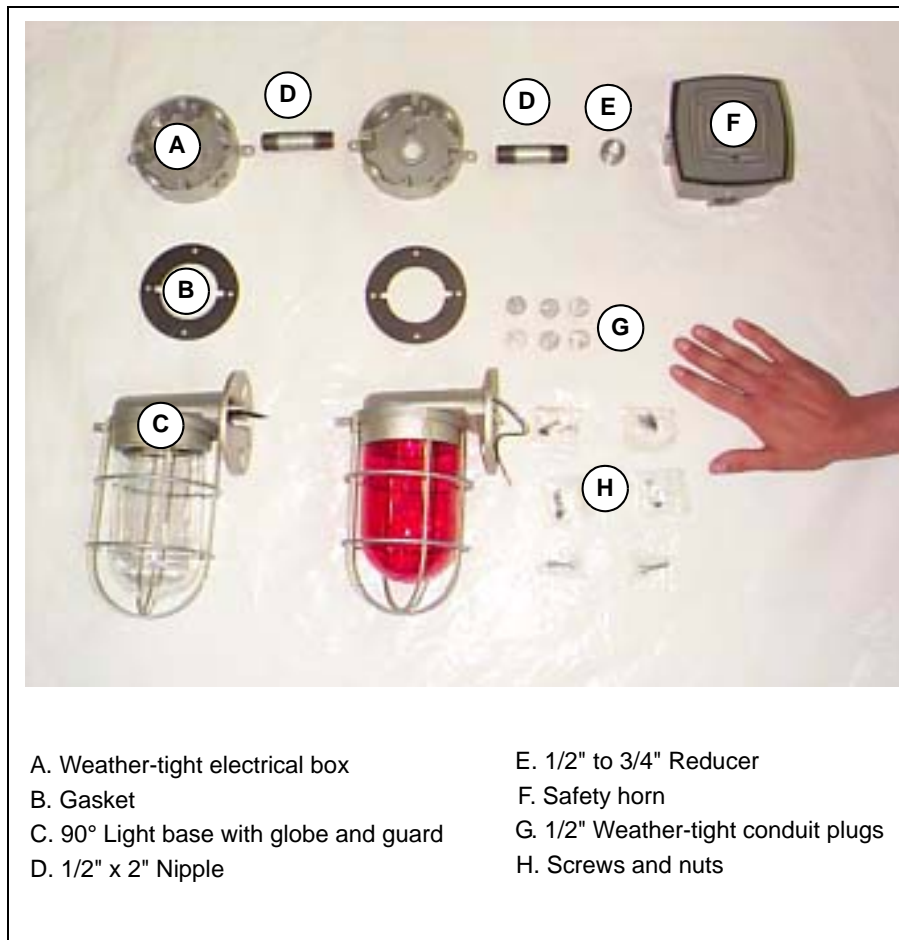
See appendices [on Pages 113-125](#) for wiring notes and schematics, etc. ([See Pages 120 and 121.](#))

## Work Light, Safety Light and Safety Horn

Install lights and horn with parts provided in kits.

1. Determine where conduit for work light, safety horn and safety light exits power box. Knock out opening for 1/2" conduit. Install myers hub.
2. Locate lights and horn according to customer preference. Often lights and horn are installed on dryer above power box. If so, run conduit up dryer to above power box.
3. Measure for lights and horn.
4. Check with level.
5. Drill holes and install lights and horn.
6. Pull #14 wires.

*See Appendix C Power Box Wiring - Field Notes on Pages 120 and 121.*



**Figure 13A**

13. Lights and Safety Horn



Figure 13B Front View - Lights and safety package installed on 3 fan dryer.



Figure 13C Rear View - Lights and safety package installed on 3 fan dryer.



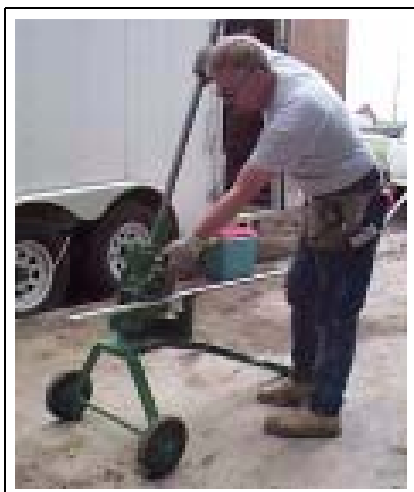
## Recommended Tools and Equipment List



### **Important Safety Precautions:**

**Dryer parts have sharp edges. Use appropriate personal protective equipment. Use proper lifting technique.**

- Forklift(s) or tractor (optional to place electrical control system) with 2" x 14' nylon lifting straps, rating 2000 pounds.
- Wrenches: 1/2", 7/16", 9/16", 5/8", 11/16", 3/4", 15/16"  
Hex wrenches (allen wrenches): 1/8", 5/32", 3/16", 3/8"
- Drill: 3/8" Bits, assorted drill bits  
Hammer drill: 1/2" Masonry bits (to anchor power box)
- Screwdrivers: #2 Standard flat blade, phillips head  
Pliers: Side cut, tongue and groove, locking (vise grips), channel lock
- Ladders: Stepladder, 4', 8', extension
- 3/8" Alignment punches
- 13 Ounce ball-peen hammer
- Banding cutters
- Tape measure
- Wire stripper
- 12" Level (install horizontal conduit as level as possible)
- Conduit deburring tool
- 1/2" Pipebender (*See Figure 14A.*)
- Reciprocating saw (*See Figure 14B*) or hacksaw and pipe joint compound or heavy duty thread sealing compound
- Hydraulic punch driver set (*See Figure 14C on Page 114*) or manual knock out with 1/2" to 2" knock out punches
- Fish tape (*See Figure 14D on Page 114.*)
- Pipe threader (*See Figure 14E on Page 114.*)



**Figure 14A** Hand Bender for 1/2" Aluminum Conduit



**Figure 14B** Hand Threader for 1/2" Aluminum Conduit

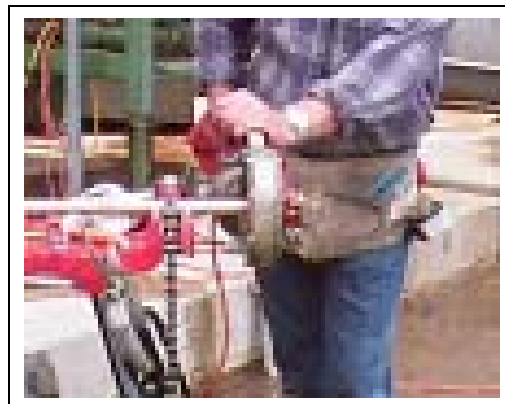
## Recommended Tools and Equipment List (Continued)



**Figure 14C** Standard "Knock Out Set"



**Figure 14D** Standard 100' "Fish Tape"

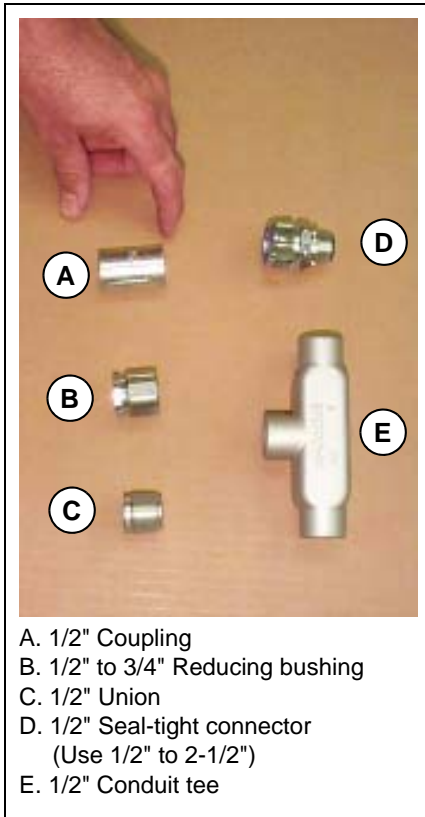


**Figure 14E** Pipe Vise and Hand Threader 1/2"

# Hardware

## Part

Running conduit..... Solid conduit (10' lengths - cut to size)  
 (aluminum, rigid or IMC (intermediate conduit))  
 uni-strut (10' lengths - cut to size)  
 1/2" to 2-1/2" seal-tight flexible conduit.



**Figure 15A**



**Figure 15C** Weather-tight Myers Hub - Portion installed to rear of power box (connects to portion inside power box).

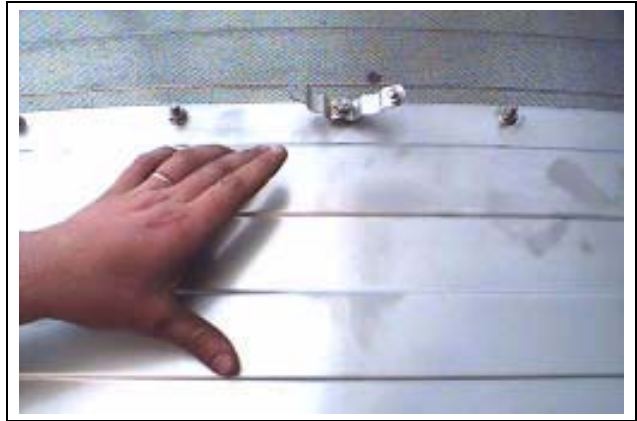


**Figure 15B** Weather-tight Myers Hub - Portion installed inside power box.

## Hardware



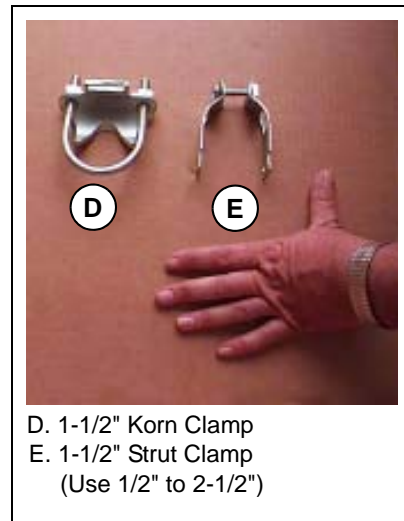
**Figure 15D** 4" Junction box as packaged for shipping.



**Figure 15G** Conduit Hanger



**Figure 15E** 4" Junction Box

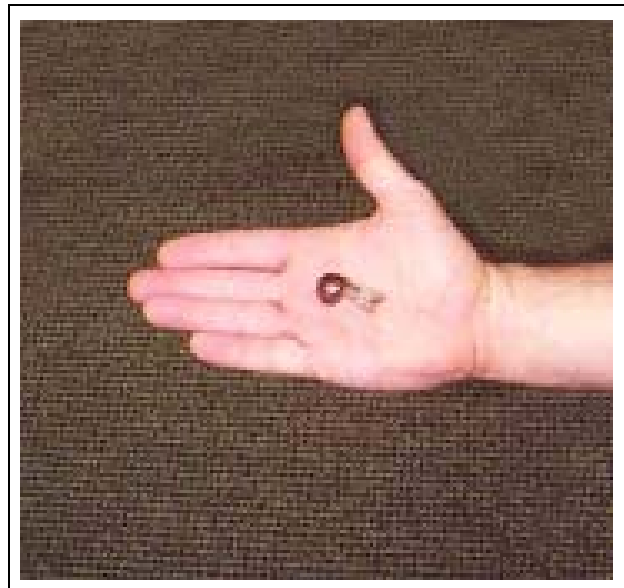


D. 1-1/2" Korn Clamp  
E. 1-1/2" Strut Clamp  
(Use 1/2" to 2-1/2")

**Figure 15H**



**Figure 15F** 1-1/2" LB-Body with gasket and cover. (Use 1/2" to 2-1/2".)



**Figure 15I** Insulated clip for copper capillaries.

## Hardware (Continued)

### Part

Air switches .....	3/8" Copper tubing, insulated clips, wire ties.
Pilot fuel train .....	3/8" Copper tubing, wire ties, liquid-tight cable connector (Appleton, Hayco, strain relief).
Metering unload device .....	Crimp connector or wire nuts, 1/2" seal-tight connector myers hub.
Ignitor (spark plug) and flame sensor .....	Rubber boot, ( <i>See Figure 15A on Page 115 to Figure 15I on Page 116</i> ) mini clamp, beam clamp, insulated clips, 6" or 8" electrical wire ties, 5/16" whiz nuts, #14 eyelet connector, beam clamp two (2) LB-bodies with cover and gasket, liquid-tight cable connector (Appleton, Hayco, strain relief).
Interior high-limits .....	#14 Fork connector, crimp connector or wire nuts, 5/16" whiz nuts, insulated clips.
Adjustable plenum high-limit thermostat (overheat) .....	#14 Fork connector, crimp connector or wire nuts.
Plenum temperature sensor (RTD).....	Crimp connector or wire nuts.
Exterior high-limits (overheat).....	Crimp connector or wire nuts.
Bindicator(s).....	#14 Fork connector.
Grain temperature sensors (RTD's).....	Tee conduit, crimp connector or wire nuts.
Maxon valve.....	(Wire according to diagram.)
Modutrol motor.....	(Wire according to diagram.)
Pilot solenoid .....	Crimp connector or wire nuts.
Fan motors.....	Split bolt connectors (6 per fan) liner-less rubber splicing tape, for low and high-voltage scotch 33+ electrical tape.

## Hardware (Continued)

## 2008 Tower Dryer Main Circuit Breaker Size

Dryer Model #	Blower HP	Volts	Motor FLA (Mar.)	Full Load Amps (480 V) <sup>1/</sup>	Full Load at 1.25 Largest Motor <sup>2/</sup>	Circuit Breaker with 20% S.F.	Main Circuit Breaker Size (Amps)	G.E. Main Breaker Frame #	G.E. Main Breaker Trip #
1200/1210	60	460	70	112.5	130.0	156.0	200	SGHA36AT0400	SRPG400A200
1500/1512	75	460	86	128.5	150.0	180.0	200	SGHA36AT0400	SRPG400A200
1800/1816	75	460	86	128.5	150.0	180.0	200	SGHA36AT0400	SRPG400A200
2000/2018	100	460	115	157.5	186.3	223.5	300	SGHA36AT0400	SRPG400A300
2400/2420	100	460	115	157.5	186.3	223.5	300	SGHA36AT0400	SRPG400A300
2500/2521	3 at 40	460	47	183.5	195.3	234.3	300	SGHA36AT0400	SRPG400A300
3000/3026	3 at 50	460	59	219.5	234.3	281.1	300	SGHA36AT0400	SRPG400A300
3500/3531	3 at 60	460	70	252.5	270.3	324.0	400	SGHA36AT0400	SRPG400A400
4000/4036	3 at 75	460	86	300.5	322.0	386.4	400	SGHA36AT0400	SRPG400A400
4718/4742	3 at 75	460	86	300.5	322.0	386.4	400	SGHA36AT0400	SRPG400A400
5000/5046	3 at 100	460	86	300.5	408.0	489.6	500	SGHA36AT0600	SRPG600A500
6000/6055	3 at 100	460	115	387.5	531.3	637.5	500	SGHA36AT0600	SRPG600A500
7000/7060	3 at 125	460	144	474.5	654.5	785.4	600	SGHA36AT0600	SRPG600A600
10000/10900	4 at 125	460	144	618.5	654.5	785.4	800	SGHA36AT0800	SRPG600A800
1200/1210	60	230	140	212.5	247.5	297.0	300	SGHA36AT0400	SRPG400A300
1500/1512	75	230	172	244.5	287.5	345.0	400	SGHA36AT0400	SRPG400A400
1800/1816	75	230	172	244.5	287.5	345.0	400	SGHA36AT0400	SRPG400A400
2000/2018	100	230	230	302.5	360.0	432.0	400	SGHA36AT0400	SRPG400A400
2400/2420	100	230	230	302.5	360.0	432.0	400	SGHA36AT0400	SRPG400A400
2500/2521	3 at 40	230	94	354.5	378.0	453.6	500	SGHA36AT0600	SRPG600A500
3000/3026	3 at 50	230	118	426.5	456.0	547.2	600	SGHA36AT0600	SRPG600A600
3500/3531	3 at 60	230	140	492.5	527.5	633.0	600	SGHA36AT0600	SRPG600A600
4000/4036	3 at 75	230	172	588.5	631.5	757.8	800	SGHA36AT0800	SRPG800A800
4718/4742	3 at 75	230	172	588.5	631.5	757.8	800	SGHA36AT0800	SRPG800A800
5000/5046	3 at 100	230	230	762.5	820.0	984.0	1000	Not Recommended	Not Recommended
6000/6055	3 at 100	230	230	762.5	820.0	984.0	1000	Not Recommended	Not Recommended
7000/7060	3 at 125	230	288	936.5	1008.5	1210.2	-	Not Recommended	Not Recommended
10000/10900	4 at 125	230	288	1224.5	1296.5	1555.8	-	Not Recommended	Not Recommended

**NOTE <sup>1/</sup>:** Dryer full load amps assumes a 10 HP fill and unload conveyor on 460V dryers and a 7-1/2 HP fill and unload conveyor on 230 volt dryers.

**NOTE <sup>2/</sup>:** Used to determine minimum main circuit breaker and electrical service size by code.

Invertor at 230V = 16.5 Amps

Invertor at 460V = 8.5 Amps

7-1/2 HP motor at 230V = 22 Amps

10 HP motor at 460V = 14 Amps

## Hardware (Continued)

## Fan Motor Wiring Guide

Dryer Model #	Voltage	Conduit, IMC* (Diameter)	# of Conduits (10' Lengths)	Wire Size	Wire Required (ft.)
1200	230	2"	3	0	150'
	380	1-1/2"	3	1	150'
	460	1-1/4"	3	3	150'
	575	1-1/4"	3	4	150'
1500	230	2-1/2"	3	250	150'
	380	2"	3	0	150'
	460	1-1/2"	3	1	150'
	575	1-1/4"	3	3	150'
1800	230	2-1/2"	4	250	150'
	380	2"	4	0	150'
	460	1-1/2"	4	1	150'
	575	1-1/4"	4	3	150'
2000	230	2-1/2"	4	350	150'
	380	2"	4	0	150'
	460	2"	4	0	150'
	575	1-1/2"	4	1	150'
2500	230	1-1/2"	12	1	450'
	380	1-1/4"	12	4	450'
	460	1"	12	6	450'
	575	1"	12	6	450'
3000	230	2"	12	0	450'
	380	1-1/4"	12	3	450'
	460	1-1/4"	12	4	450'
	575	1"	12	6	450'
3500	230	2"	14	0	450'
	380	1-1/2"	14	1	450'
	460	1-1/4"	14	3	450'
	575	1-1/4"	14	4	450'
4000	230	2-1/2"	15	250	450'
	380	2"	15	0	450'
	460	1-1/2"	15	1	450'
	575	1-1/4"	15	3	450'
5000	460	1-1/2"	20	1	600'
6000	460	2"	24	0	600'
7000	460	2"	24	0	600'

\*IMC = Intermediate conduit.

## 16. Appendix C

### Dryer Field Wiring to Panel - Size and Color

Parts or Devices		All Tower Dryers	
Wire Gauges (AWG)	Wire Color	Terminal Strip Wire #	Ending Location
<b>Upper Grain Level Bindicator (UBS)</b>			
18 Gauge	Blue	PLC+	Common
18 Gauge	Yellow	314	N.O. - Normally Open
16 Gauge	Black	L-1.1	Line for Motor
16 Gauge	White	L-2	Neutral for Motor
16 Gauge	Green or Green/Yellow	Ground	Ground
<b>Lower Grain Level Bindicator (LBS)</b>			
18 Gauge	Blue	PLC+	Common
18 Gauge	Brown	315	N.O. - Normally Open
16 Gauge	Black	L-1.1	Line for Motor
16 Gauge	White	L-2	Neutral for Motor
16 Gauge	Green or Green/Yellow	Ground	Ground
<b>Grain Temperature Sensor - RTD (MC)</b>		<b>A-B 1746 RTD Card</b>	
20 Gauge Shielded Cable	White (N/A)	MC8	RTD
20 Gauge Shielded Cable	Black (White)	MC7	SEN
20 Gauge Shielded Cable	Red (Black)	MC6	RTN
20 Gauge Shielded Cable	Shield	Ground shield on one end of cable only.	
<b>Plenum Temperature Sensor - RTD (PC)</b>		<b>A-B 1746 RTD Card</b>	
20 Gauge Shielded Cable	White (N/A)	PC8	RTD
20 Gauge Shielded Cable	Black (White)	PC7	SEN
20 Gauge Shielded Cable	Red (Black)	PC6	RTN
20 Gauge Shielded Cable	Shield	Ground shield on one end of cable only	
<b>Interior High-Limits</b>			
18 Gauge	Blue	PLC+	24V DC
18 Gauge	Yellow	107	Inside Left Overheat
18 Gauge	Brown	108	Inside Right Overheat
<b>Adjustable High-Limit</b>			
18 Gauge	Blue	PLC+	24V DC
18 Gauge	Yellow	109	Inside Adjustable Overheat
<b>Exterior High-Limits</b>			
18 Gauge	Blue	PLC+	24V DC
18 Gauge	Red	101	Upper Left Overheat
18 Gauge	Yellow	102	Upper Right Overheat
18 Gauge	Brown	103	Middle Left Overheat
18 Gauge	Orange	104	Middle Right Overheat
18 Gauge	Purple	105	Lower Left Overheat
18 Gauge	Black	106	Lower Right Overheat



## Dryer Field Wiring to Panel - Size and Color (Continued)

Parts or Devices		All Tower Dryers	
Wire Gauges	Wire Color	Terminal Strip Wire #	Ending Location
<b>Gas Train Components</b>			
18 Gauge	Blue	PLC+	24V DC
18 Gauge	White	L2	Neutral
18 Gauge	Orange	505	Pilot Solenoid
18 Gauge	Brown	MVS	Terminal #1 on First Maxon
18 Gauge	Black	113	Terminal #9 on Second Maxon
18 Gauge	Purple	111	High Pressure Gas Switch
18 Gauge	Yellow	110	Low Pressure Gas Switch
18 Gauge	Red	L-1.1	L1 on Modulating Motor
18 Gauge	Red	Vent Solenoid	If Applicable
20 Gauge Shielded Cable	Black	CM+	Modulating 4-20 mA
20 Gauge Shielded Cable	White or Clear	CM-	Modulating 4-20mA
16 Gauge	Green or Green/Yellow	Panel Ground	Ground at each component
<b>Safety Horn and Lights</b>			
18 Gauge	White	L2	Neutral
18 Gauge	Red	409	Working Light (Clear)
18 Gauge	Black	414	Alarm Light (Red)
18 Gauge	Brown	415	Alarm Horn
<b>Ignitor</b>			
Ignition Wire	7 mm (Special)	Ignition Transformer	Ignitor Plug at Burner
<b>Flame Sensing</b>			
14 Gauge	Red	E-Terminal on Protectofier	Flame Rod at Burner
14 Gauge	Green or Green/Yellow	Panel Ground	Ground at Burner
<b>Unload Sweep or Metering Unload Device</b>			
10 Gauge for (230 VAC)	Black	A-B AC Inverter (U, V, W)	AC Unload Motor (L1, L2, L3)
14 Gauge for (230 VAC)	Black	A-B AC Inverter (U, V, W)	AC Unload Motor (L1, L2, L3)
12 Gauge/16 Gauge	Green or Green/Yellow	Panel Ground	Ground at Motor

# Tower Dryer Control Panel Wiring Diagram

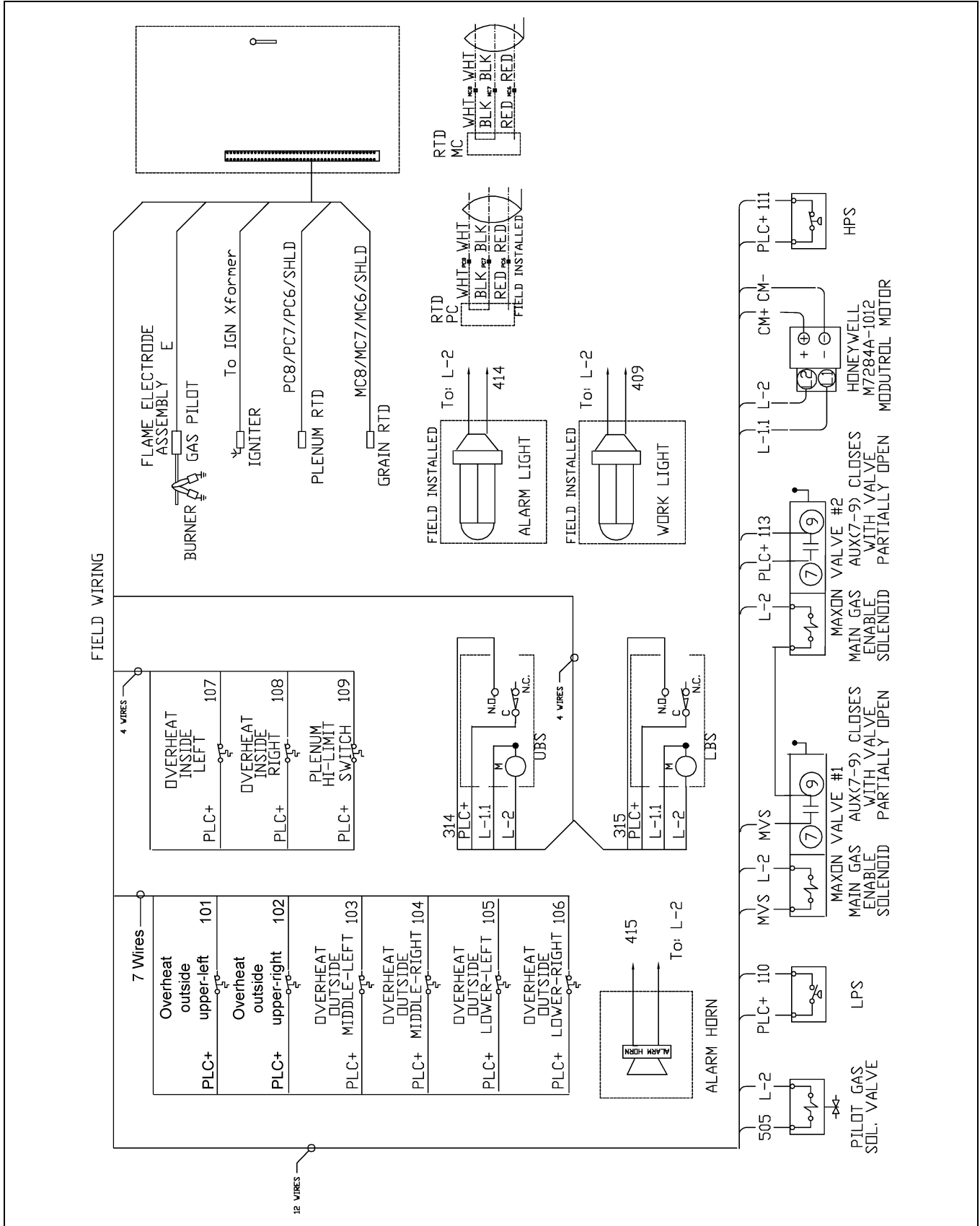


Figure 17A

# Tower Dryer Control Panel Wiring Diagram (Continued)

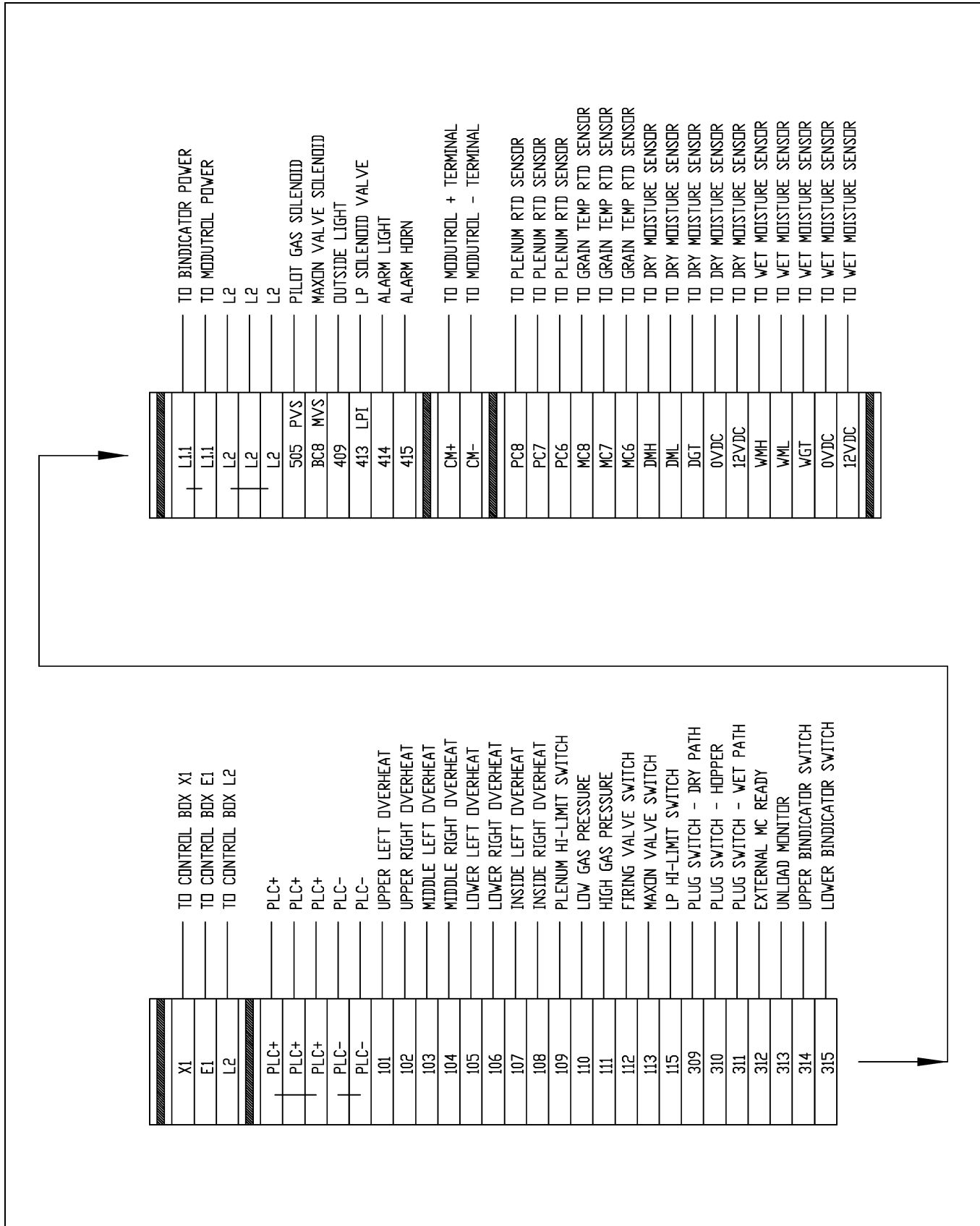


Figure 17B

# Gas Train Wiring Schematic Diagram

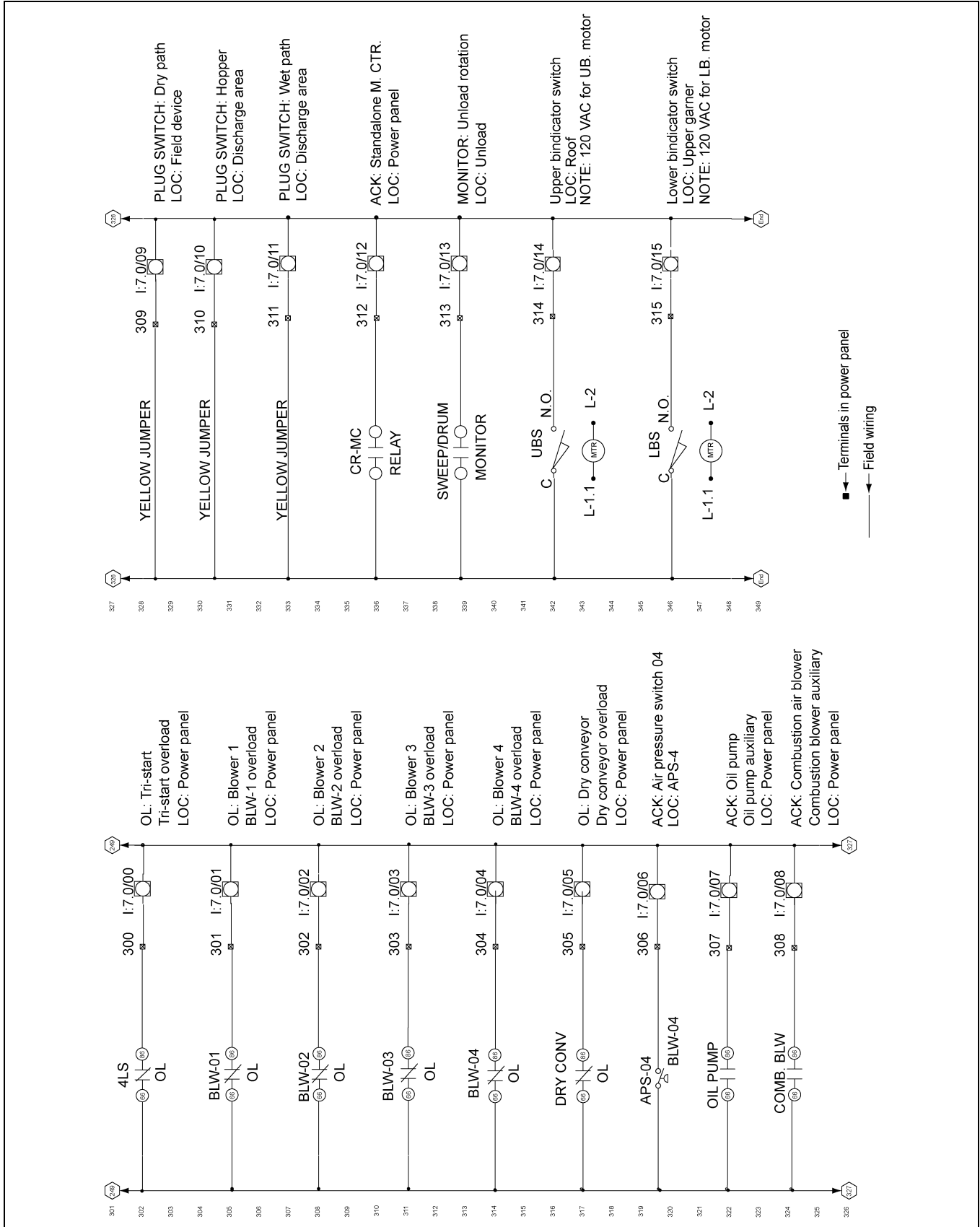


Figure 17C

# Gas Train Wiring Schematic Diagram (Continued)

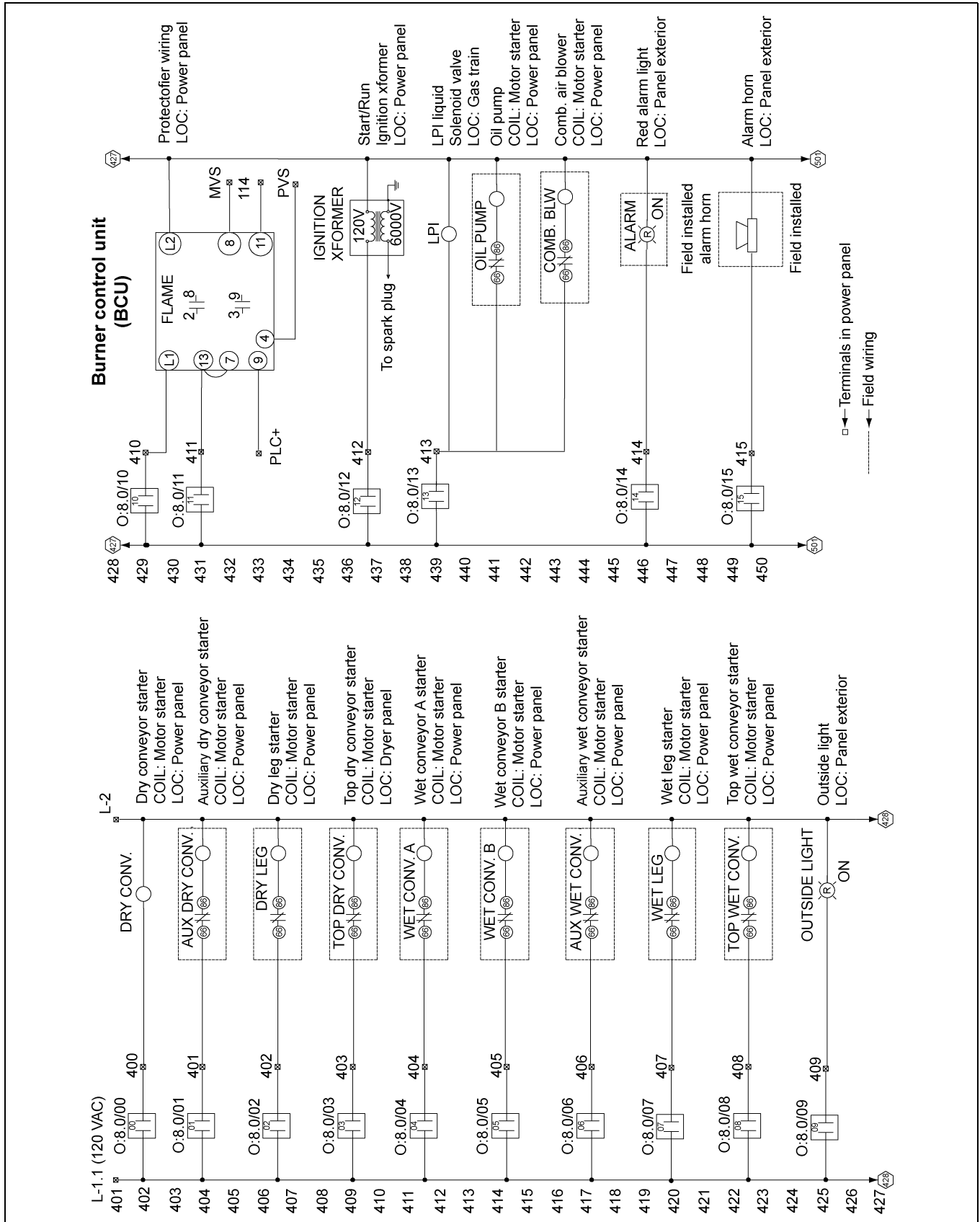


Figure 17D

# Fuel Train with Pilot Fuel Line

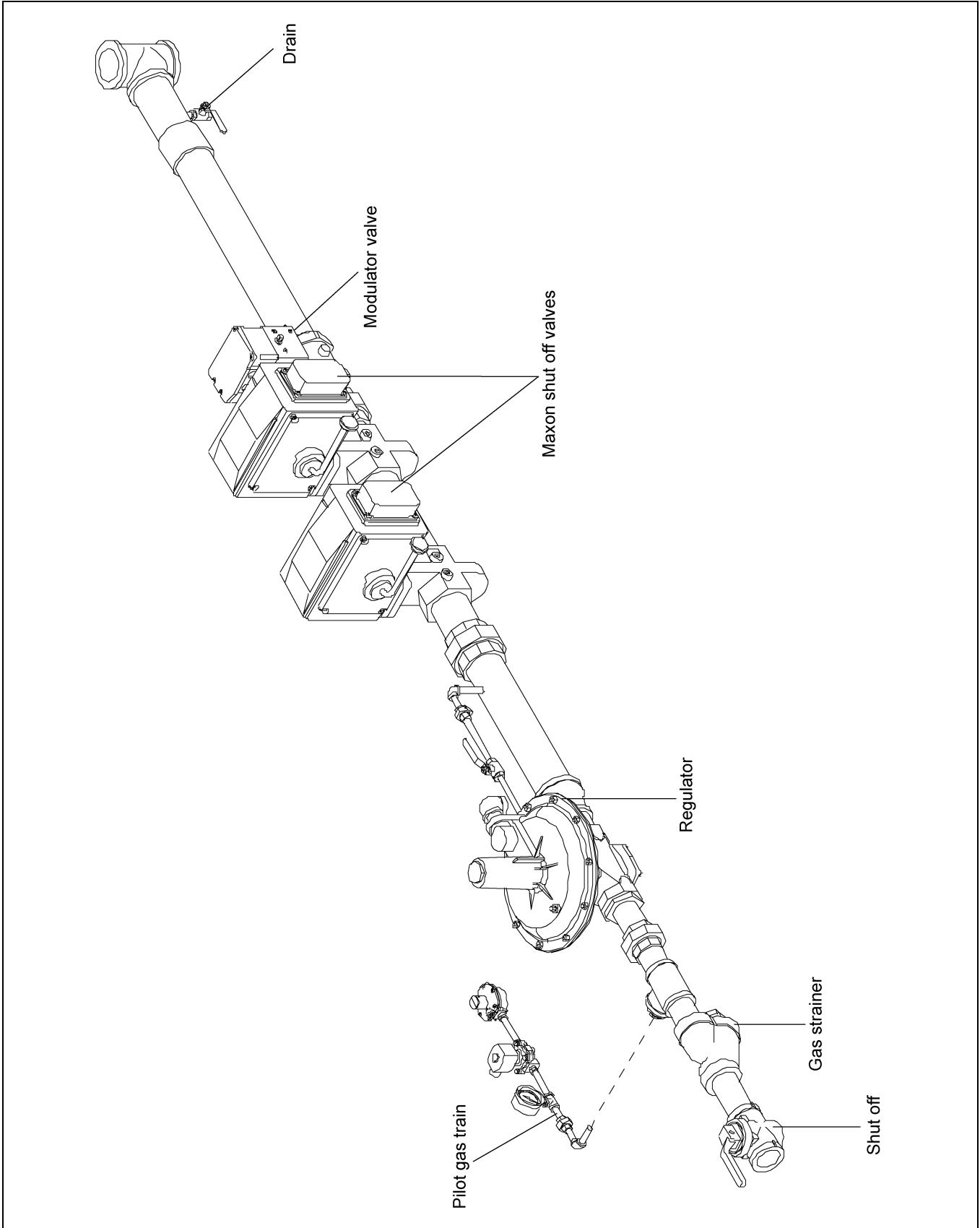


Figure 18A

# Cutaway - Ignitor and Flame Sensor Conduits

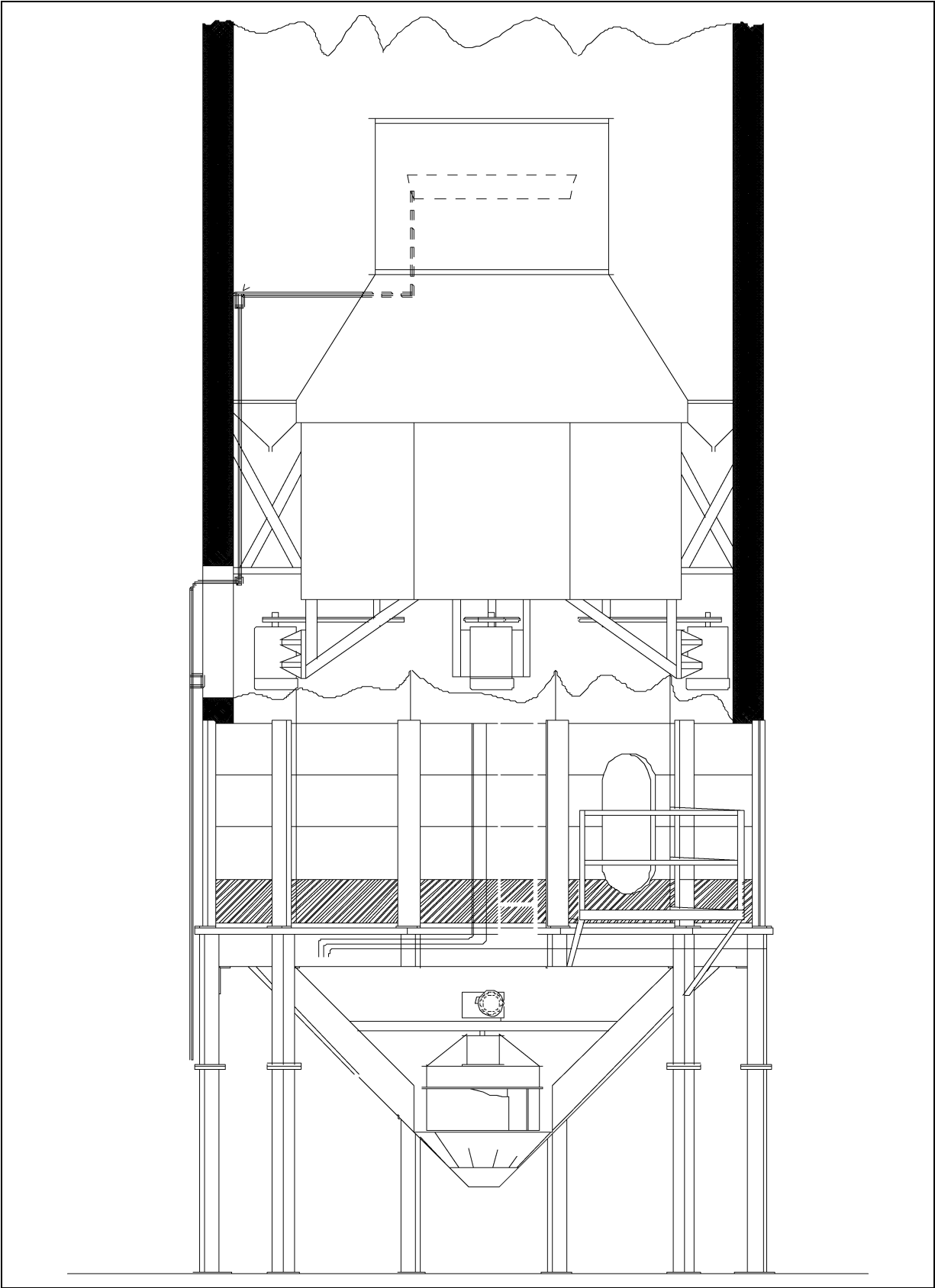


Figure 19A

# Sensor and Conduit Location

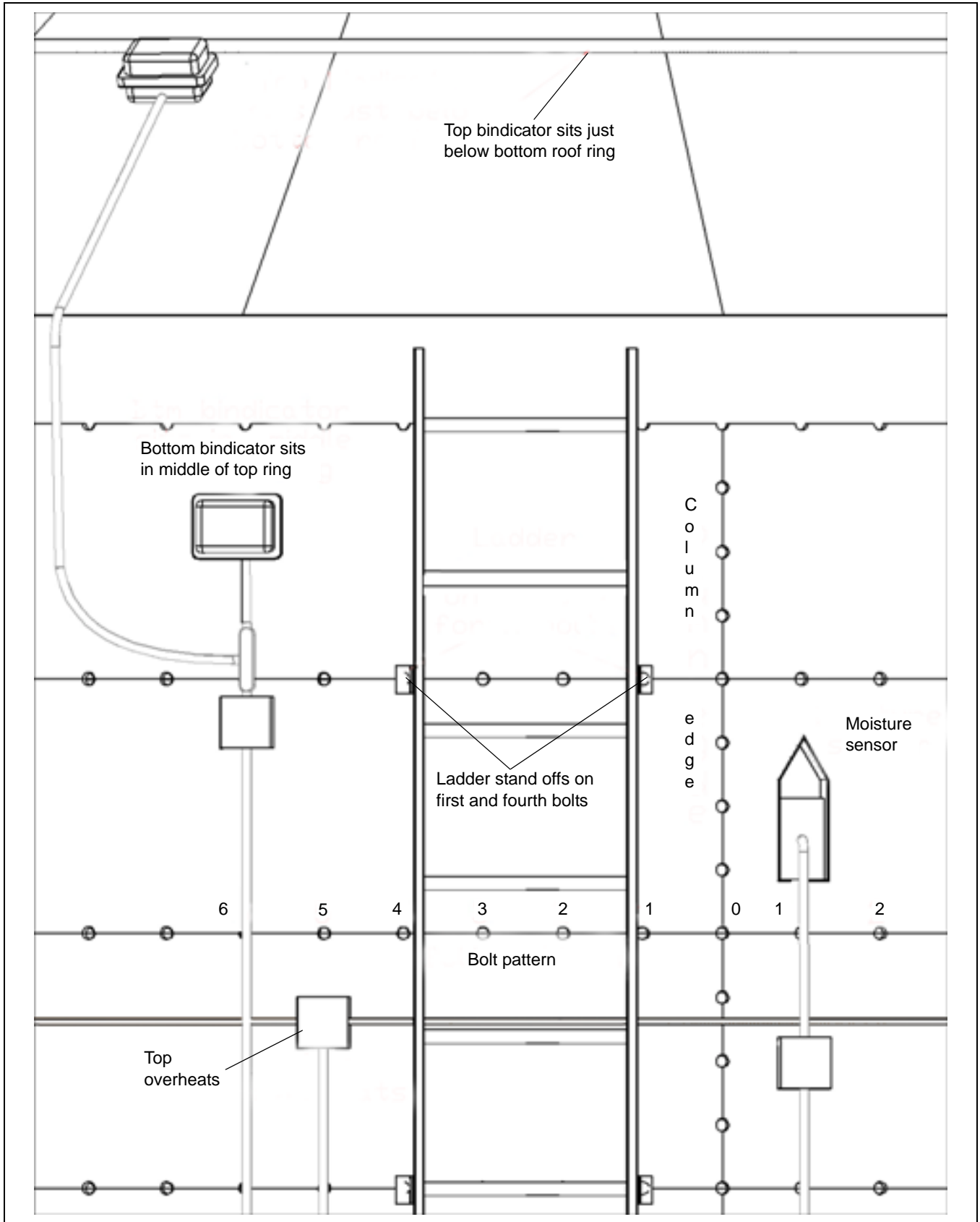


Figure 19B



# Exterior Sensors Conduits

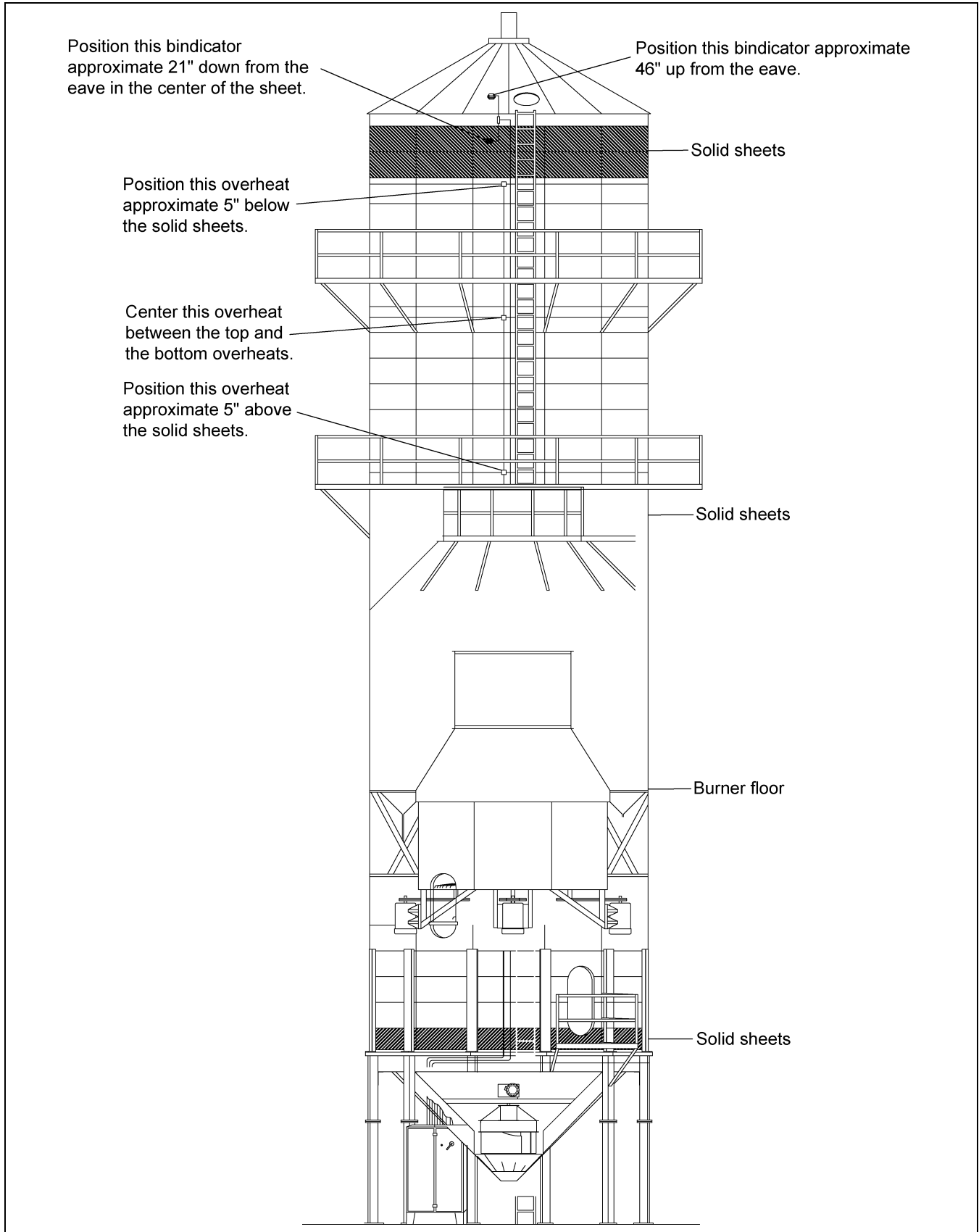


Figure 20A

# Tower Cutaway

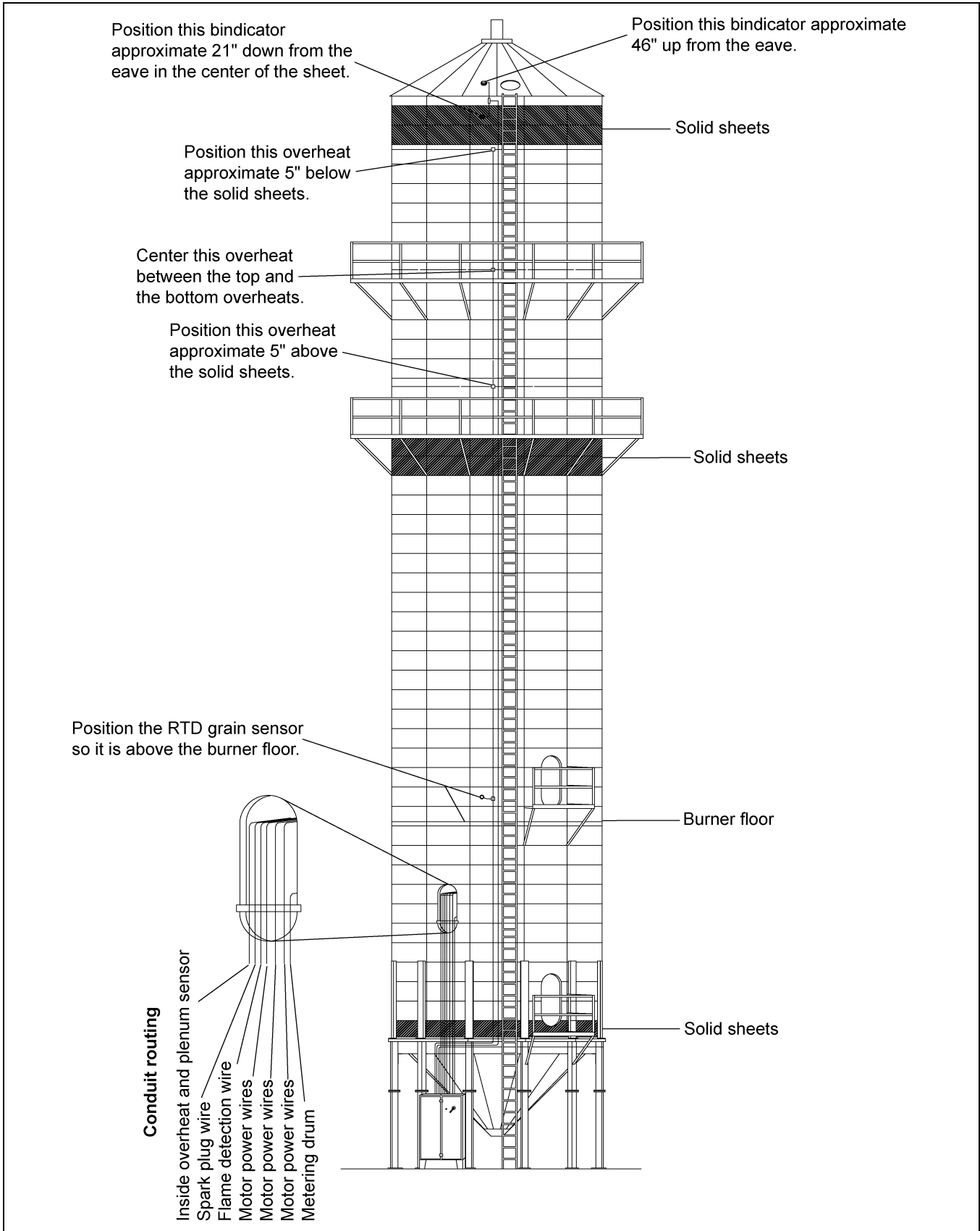


Figure 21A

## Tower Cutaway (Continued)

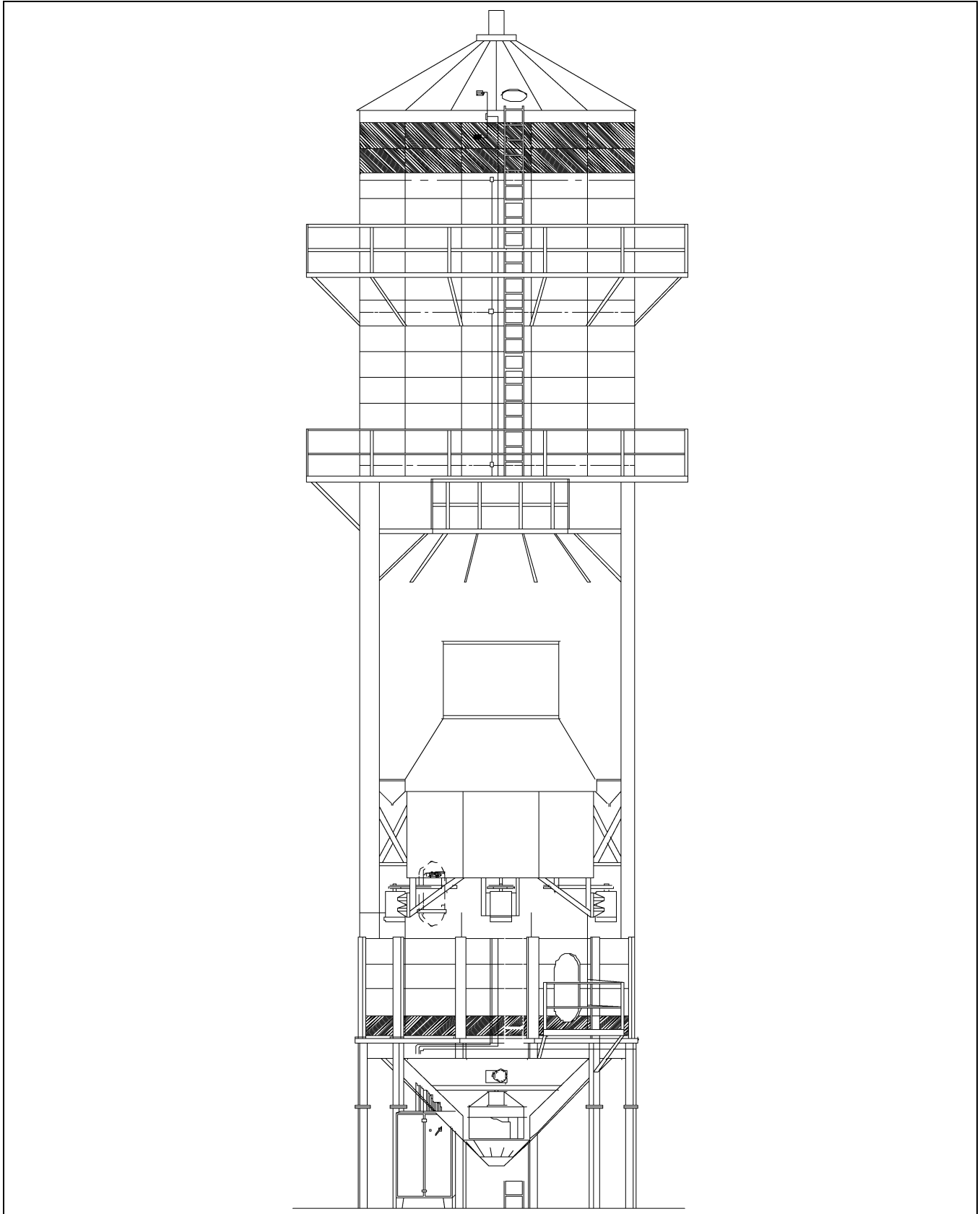


Figure 21B

## Glossary of Installation Terms

<b>Terms</b>	<b>Meaning</b>
BPH.....	Bushels Per Hour
Cable connectors .....	Liquid-tight cable connector (strain relief), Appleton, Heyco.
Flexible conduit .....	Brand names include seal-tight, ultra-tight, etc.
Heavy duty thread sealing compound.....	Also called pipe thread sealer, pipe dope.
Field notes .....	Electrician's working summary of wiring requirements.
Hoppers .....	<p>Divider hopper - funnels any debris to cooling section (divides heating section from cooling section).</p> <p>Discharge hopper - discharges grain at bottom of dryer, it consists of inner hopper and outer hopper.</p> <p><b>Inner hopper wall</b> - directs grain to metering device (below cooling section floor).</p> <p><b>Outer hopper wall</b> - discharges grain from dryer.</p>
Motor window .....	Dryer fan motors conduits enter through motor window.
RTD.....	Resistance temperature device.
R.H.....	Right hand.
L.H. ....	Left hand.
Venturi.....	Tube, e.g., curved inner wall of fan that constricts to increase air velocity and lower air pressure.

## U.S. to Metric Conversion Tables

*Refer to Conversion Tables* in appendix J for conversions from U.S. measures to metric measurements.

To assemble this grain dryer, you may need standard U.S. dimension tools. However, some metric tools will fit on U.S. dimension hardware.

### Inch Conversion Table

Fractions	Decimals	Millimeters	Fractions	Decimals	Millimeters
1/64	0.0156	0.3969	33/64	0.5156	13.0969
1/32	0.0313	0.07938	17/32	0.5313	13.4938
3/64	0.0469	1.1906	35/64	0.5469	13.8906
1/16	0.0625	1.5875	9/16	0.5625	14.2875
5/64	0.0781	1.9844	37/64	0.5781	14.6844
3/32	0.0938	2.3813	19/32	0.5938	15.0813
7/64	0.1094	2.7781	39/64	0.6094	15.4781
1/8	0.125	3.1750	5/8	0.625	15.8750
9/64	0.1406	3.5719	41/64	0.6406	16.2719
5/32	0.1563	3.9688	21/32	0.6563	16.6688
11/64	0.1719	4.3656	43/64	0.6719	17.0656
3/16	1.875	4.7625	11/16	0.6875	17.4625
13/64	0.2031	5.1594	45/64	0.7031	17.8594
7/32	0.2188	5.5563	23/32	0.7188	18.2563
15/64	0.2344	5.9531	47/64	0.7344	18.6531
1/4	0.250	6.3500	3/4	0.750	19.0500
17/64	0.2656	6.7469	49/64	0.7656	19.4469
9/32	0.2813	7.1438	25/32	0.7813	19.8438
19/64	0.2969	7.5406	51/64	0.7969	20.2406
5/16	0.3125	7.9375	13/16	0.8125	20.6375
21/64	0.3281	8.3344	53/64	0.8281	21.0344
11/32	0.3438	8.7313	27/32	0.8438	21.4313
23/64	0.3594	9.1281	55/64	0.8594	21.8281
3/8	0.375	9.5250	7/8	0.875	22.2250
25/64	0.3906	9.9219	57/64	0.8906	22.6219
13/32	0.4063	10.3188	29/32	0.9063	23.0188
27/64	0.4219	10.7156	59/64	0.9219	23.4156
7/16	0.4375	11.1125	15/16	0.9375	23.8125
29/64	0.4531	11.5094	61/64	0.9531	24.2094
15/32	0.4688	11.9063	31/32	0.9688	24.6063
31/64	0.4844	12.3031	63/64	0.9844	25.0031
1/2	0.500	12.7000	1	1.000	25.4000

## U.S. to Metric Conversion Tables (Continued)

### Conversion Factors

Multiply	By	To Obtain
British Thermal Unit (Btu)	$2.928 \times 10^{-4}$	Kilowatt · Hr (kWh)
Btu/Hr	$3.930 \times 10^{-4}$	Horsepower (HP)
Btu/Hr	0.293	Watt (W)
Horsepower (HP)	745.7	Watt (W)
Inch (in.)	2.540	Centimeter (cm)
Foot (ft.)	0.3048	Meter (m)
Pound-mass (lbm avdp*)	0.454	Kilogram (kg)
Pounds per Square Inch (PSI)	6,895	Pascal (Pa)
Bushels (BU)	0.03524	Cubic Meter (m <sup>3</sup> )
°F (Fahrenheit)	$(F^{\circ}-32) / 1.8$	°C (Celsius)
°C (Celsius)	$1.8 (C^{\circ}) + 32$	°F (Fahrenheit)

\*avdp = avoirdupois

### AWG\* Wire Gauge (Solid Conductor Wire)

AWG Gauge #	Cross Sectional Area		Diameter of Solid Wire	Circular
	mm <sup>2</sup>	inches <sup>2</sup>	mm	mils
32	0.0032	0.00005	0.0202	63.2
30	0.0505	0.000079	0.255	100.5
28	0.0806	0.000125	0.321	159.8
26	0.129	0.000199	0.405	254
	0.196	0.000304	0.5	387
24	0.205	0.000317	0.511	404
	0.283	0.00483	0.6	558
20	0.518	0.000802	0.812	1022
	0.75	0.001162	0.977	1480
18	0.821	0.001272	1.022	1620
	1	0.00155	1.128	1973
16	1.307	0.002026	1.29	2580
	1.5	0.002325	1.382	2960
14	2.082	0.003228	1.628	4110
	2.5	0.003875	1.784	4934
12	3.309	0.005129	2.053	6530
	4	0.0062	2.257	7894
10	5.26	0.008152	2.588	10380
	6	0.0093	2.763	11841
8	8.365	0.012967	3.264	16540
	10	0.0155	3.568	19735
6	13.296	0.02061	-	26240
	16	0.0248	-	31576
4	21.15	0.03278	-	41740
	25	0.0388	-	49338
2	33.62	0.0521	-	66360

\*Awg = American wire gauge.

## Dryer Decals Used on Structure

All stickers will be installed by electrical installations crews and/or start-up personnel.

1. DC-2014 - Decal, Fill tube for tower dryer - 2 - EA
  - a. Will be installed in inlet fill tube/spout.
2. 420-1473 - Decal, Danger confined space - 2 - EA
  - a. Will be installed at any and all access doors on dryer.
3. DC-1060 - Decal, Danger rotating drum - 2 - EA
  - a. Will be installed at Zimmermen/GSI walk-in floor access ports to unload system.
4. DC-1061 - Decal, Warning flame and pressure - 2 - EA
  - a. Will be installed at all heat section access door.
5. DC-1062 - Decal, Danger - 2 - EA
  - a. Will be installed at Zimmerman/GSI walk-in floor access ports to unload system.
6. DC-1064 - Decal, Warning high speed belt - 1 - EA
  - a. Will be installed at cooling sections access door.
7. DC-1224 - Decal, Danger high voltage (LG) - 2 - EA
  - a. Will be installed at cooling access door and main power panel.
8. DC-1901 - Decal, Warning; No step - 6 - EA
  - a. Unknown - Check with engineering safety.
9. DC-GBC-1A - Decal, Suffocation/Flighting - 1 - EA
  - a. Unknown - Check with engineering safety.
10. DC-GBC-1S - Decal, Suffocation/Flighting - 1 - EA
  - a. Unknown - Check with engineering safety.

---

# NOTES



## Limited Warranty - N.A. Grain Products

The GSI Group, LLC. ("GSI") warrants products which it manufactures, to be free of defects in materials and workmanship under normal usage and conditions for a period of 12 months from the date of shipment (or, if shipped by vessel, 14 months from the date of arrival at the port of discharge). If, in GSI's sole judgment, a product is found to have a defect in materials and/or workmanship, GSI will, at its own option and expense, repair or replace the product or refund the purchase price. This Limited Warranty is subject to extension and other terms as set forth below.

### Warranty Enhancements:

The warranty period for the following products is enhanced as shown below and is in lieu of (and not in addition to) the above stated warranty period. (Warranty Period is from date of shipment.)

	Product	Warranty Period
<b>Storage</b>	Grain Bin Structural Design	5 Years
	• Sidewall, roof, doors, platforms and walkarounds	
	• Flooring (when installed using GSI specified floor support system for that floor)	
<b>Conditioning</b>	• Hopper tanks (BFT, GHT, NCHT, and FCHT)	5 Years
	Dryer Structural Design - (Tower, Portable and TopDry)	
	• Includes (frame, portable dryer screens, ladders, access doors and platforms)	
	All other Dryer parts including:	
<b>Material Handling</b>	• Electrical (controls, sensors, switches and internal wiring)	2 Years
	All Non-PTO Driven Centrifugal and Axial Fans	3 Years
	Bullseye Controllers	2 Years
	Bucket Elevators Structural Design	5 Years
<b>Material Handling</b>	Towers Structural Design	5 Years
	Catwalks Structural Design	5 Years
	Accessories (stairs, ladders and platforms) Structural Design	5 Years

### Conditions and Limitations:

THERE ARE NO WARRANTIES THAT EXTEND BEYOND THE LIMITED WARRANTY DESCRIPTION SET FORTH HEREIN; SPECIFICALLY, GSI DISCLAIMS ANY AND ALL OTHER WARRANTIES OF ANY KIND, EXPRESS OR IMPLIED, INCLUDING, WITHOUT LIMITATION, WARRANTIES OF MERCHANTABILITY OR FITNESS FOR A PARTICULAR PURPOSE OR USE IN CONNECTION WITH: (I) ANY PRODUCT MANUFACTURED OR SOLD BY GSI, OR (II) ANY ADVICE, INSTRUCTION, RECOMMENDATION OR SUGGESTION PROVIDED BY AN AGENT, REPRESENTATIVE OR EMPLOYEE OF GSI REGARDING OR RELATED TO THE CONFIGURATION, INSTALLATION, LAYOUT, SUITABILITY FOR A PARTICULAR PURPOSE, OR DESIGN OF SUCH PRODUCTS.

The sole and exclusive remedy for any claimant is set forth in this Limited Warranty and shall not exceed the amount paid for the product purchased. This Warranty only covers the value of the warranted parts and equipment, and does not cover labor charges for removing or installing defective parts, shipping charges with respect to such parts, any applicable sales or other taxes, or any other charges or expenses not specified in this Warranty. GSI shall not be liable for any other direct, indirect, incidental or consequential damages, including, without limitation, loss of anticipated profits or benefits. Expenses incurred by or on behalf of a claimant without prior written authorization from the GSI warranty department shall not be reimbursed. This warranty is not transferable and applies only to the original end-user. GSI shall have no obligation or responsibility for any representations or warranties made by or on behalf of any dealer, agent or distributor. Prior to installation, the end-user bears all responsibility to comply with federal, state and local codes which apply to the location and installation of the products.

This Limited Warranty extends solely to products sold by GSI and does not cover any parts, components or materials used in conjunction with the product, that are not sold by GSI. GSI assumes no responsibility for claims resulting from construction defects, unauthorized modifications, corrosion or other cosmetic issues caused by storage, application or environmental conditions. Modifications to products not specifically delineated in the manual accompanying the product at initial sale will void all warranties. This Limited Warranty shall not extend to products or parts which have been damaged by negligent use, misuse, alteration, accident or which have been improperly/inadequately maintained.

#### Notice Procedure:

In order to make a valid warranty claim a written notice of the claim must be submitted, using the RMA form, within 60 days of discovery of a warrantable nonconformance. The RMA form is found on the OneGSI portal.

#### Service Parts:

GSI warrants, subject to all other conditions described in this Warranty, Service Parts which it manufactures for a period of 12 months from the date of purchase unless specified in Enhancements above.

(Limited Warranty - N.A. Grain Products\_ revised 01 October 2020)

This equipment shall be installed in accordance with the current installation codes and applicable regulations, which should be carefully followed in all cases. Authorities having jurisdiction should be consulted before installations are made.



**1004 E. Illinois St.**  
**Assumption, IL 62510-0020**  
**Phone: 1-217-226-4421**  
**Fax: 1-217-226-4420**  
**[www.gsiag.com](http://www.gsiag.com)**

