



ETL Listed TopDry Series 2000 Autoflow

Operators Manual

PNEG-1969

Version: 3.1

Date: 01-12-16



Intertek



PNEG-1969

Models:

(2TFC, 2AFC) - 3615(1N, 3N, 5N)(M, S)

(2TFC, 2AFC) - 4015(1N, 3N, 5N)(M, S)

(2TFC, 2AFC) - 4230(3N, 5N)(M, S)

(2TFC, 2AFC) - 4240(3N, 5N)(M, S)

(2TFC, 2AFC) - 3615(1L, 3L, 5L)(M, S)

(2TFC, 2AFC) - 4015(1L, 3L, 5L)(M, S)

(2TFC, 2AFC) - 4230(3L, 5L)(M, S)

(2TFC, 2AFC) - 4240(3L, 5L)(M, S)

All information, illustrations, photos, and specifications in this manual are based on the latest information available at the time of publication. The right is reserved to make changes at any time without notice.

Contents

Chapter 1 Safety	5
Safety Guidelines	5
Cautionary Symbols Definitions	6
Safety Cautions	7
Safety Sign-Off Sheet	13
Chapter 2 Safety Decals	14
Fan/Heater Decals	14
Chapter 3 Fuel and Electrical Specifications	16
TopDry CSA Heater Specifications	16
TopDry CSA Orifice Chart	16
Chapter 4 Electrical Installation	17
Machine to Earth Connection	17
Emergency Stop	17
Chapter 5 Heater Wiring Diagrams	18
Series 2000 TopDry CSA Master	18
Series 2000 TopDry CSA Slave	19
Ladder Logic Diagrams for TopDry CSA Master and Slave	20
Ladder Logic Diagram for TopDry Fill System	22
Chapter 6 TopDry Flow Chart	23
Dryer Global State	23
Fill Sub-System Operation	24
Dump Sub-System Operation	25
Fan-Heater Sub-System Operation	26
Burner Operation	27
Process Timer Operation	28
Chapter 7 Fuel Installation	29
Fuel Connection	29
Liquid LPG	29
Vapor LPG	29
Natural Gas	29
Chapter 8 Pipe Train Assembly	31
36" Pipe Train Sub-Assembly - LP CSA (TD-101420)	32
36" Pipe Train Sub-Assembly - NG CSA (TD-101421)	34
40" and 42" Pipe Train Sub-Assembly - LP CSA (TD-101422)	36
40" and 42" Pipe Train Sub-Assembly - NG CSA (TD-101464)	38
LP Supply Pipe Train (TD-101445)	40
Chapter 9 Control Panel	41
Dryer Control Panel	41
Chapter 10 Control System	43
Electronic Monitoring Control System	43

Table of Contents

Chapter 11	Fill System Control Box	46
Chapter 12	Error Messages	49
	Error Messages	49
	High Gas Pressure Switch	51
Chapter 13	Initial Start-Up	52
	Dryer Commissioning	52
Chapter 14	Pre-Season Checks	54
	Set Control Switches	54
	Control Power Switch	55
	Drying Chamber	56
	Rotary Switches	56
	Power Start Button	56
	Fuel Check	56
	Fan	56
	Aeration Fan	56
	Fill System	57
	Air Switch	57
	Burner Test Fire	57
	Dryer Shut Down	57
	Emergency	57
Chapter 15	Service	58
	Internal (Seat) Leakage Testing for Safety Shut Off Valves	58
Chapter 16	Autoflow Theory	60
	TopDry Autoflow Theory of Operation	60
Chapter 17	Start-Up Procedure	62
	Initial Dryer Start-Up	62
	Normal Start-Up	64
	Last Fill	64
Chapter 18	Warranty	65

Safety Guidelines

Safety guidelines are general-to-specific safety rules that must be followed at all times. This manual is written to help you understand safe operating procedures and problems that can be encountered by the operator and other personnel when using this equipment. Save these safety guidelines for future reference.

As owner or operator, you are responsible for understanding the requirements, hazards, and precautions that exist and to inform others as required. Unqualified persons must stay out of the work area at all times.

Alterations shall not be made to the equipment. Alterations can produce dangerous situations resulting in **SERIOUS INJURY** or **DEATH**.

This equipment must be installed in accordance with the current installation codes and applicable regulations, which must be carefully followed in all cases. Authorities having jurisdiction must be consulted before installations are made.

When necessary, you must consider the installation location relative to electrical, fuel and water utilities.

Personnel operating or working around equipment must read this manual. This manual shall be delivered with equipment to its owner. Failure to read this manual and its safety instructions is a misuse of the equipment.

ST-0001-3

Cautionary Symbols Definitions

Cautionary symbols appear in this manual and on product decals. The symbols alert the user of potential safety hazards, prohibited activities and mandatory actions. To help you recognize this information, we use the symbols that are defined below.



This symbol indicates an imminently hazardous situation which, if not avoided, **will result in serious injury or death.**



This symbol indicates a potentially hazardous situation which, if not avoided, **can result in serious injury or death.**



This symbol indicates a potentially hazardous situation which, if not avoided, **can result in minor or moderate injury.**



This symbol is used to address practices not related to personal injury.



This symbol indicates a general hazard.



This symbol indicates a prohibited activity.

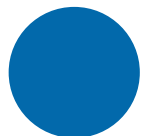

This symbol indicates a mandatory action.

ST-0005-2

Safety Cautions

Use Personal Protective Equipment

- Use appropriate personal protective equipment:

Eye Protection



Head Protection



Hearing Protection



Foot Protection



Hand Protection



Fall Protection



Respiratory Protection



- Wear clothing appropriate to the job.
- Remove all jewelry.
- Tie long hair up and back.

ST-0004-1

Follow Safety Instructions

- Warning:** If the information in the manual is not followed exactly, a fire or explosion can result, causing property damage, personal injury or loss of life.
- Carefully read all safety messages in this manual and safety signs on your machine. Keep signs in good condition. Replace missing or damaged safety signs. Be sure new equipment components and repair parts include the current safety signs. Replacement safety signs are available from the manufacturer.
- Learn how to operate the machine and how to use controls properly. Do not let anyone operate without instruction.
- If you do not understand any part of this manual or need assistance, contact your dealer.



ST-0025-2

1. Safety

For Your Safety

- If you smell gas:
 1. Do not try to light any appliance.
 2. Extinguish any open flames.
 3. Do not touch any electrical switch.
 4. Immediately call your gas supplier. Follow the gas supplier's instructions.
 5. If you cannot reach your gas supplier, call the fire department.
- The use and storage of gasoline and other flammable vapors and liquids in open containers in the vicinity of this appliance is hazardous.
- Improper installation, adjustment, alteration, service or maintenance can cause property damage, injury or death. Read the installation, operating and maintenance instructions thoroughly before installing or servicing this equipment. Installation and service must be performed by a qualified installer, service agency or the gas supplier.



ST-0024-1

Maintain Equipment and Work Area

- Understand service procedures before doing work.
- Keep area clean and dry.
- Do not service equipment while it is operating. Disconnect and lock-out power and fuel supply before entering equipment or before performing maintenance.
- Keep your equipment in proper working condition. Replace worn or broken parts immediately.
- Depressurize the fuel train before disassembling for service.
- Allow the fan to operate for 20 minutes with the burner off to purge products of combustion and to cool the components before entering.
- Check regularly for any developing gas plumbing leaks. Do not operate the dryer if any gas leak is detected. Shut down and repair before further operation.



ST-0030-2

Install and Operate Electrical Equipment Properly

- Electrical controls must be installed by a qualified electrician and must meet the standards set by the National Electric Code, Canadian Electrical Code, and all local and state codes.
- Lock-out power source before making adjustments, cleaning, or maintaining equipment.



ST-0027-2

Handle and Use Equipment Properly

- Equipment is intended for the use of grain drying only. Any other use is a misuse of this equipment.
- The operating instructions in this manual pertain to the common cereal grains as indicated. When drying any other grain, contact GSI for additional recommendations.
- On LP fired units, set pressure regulator to avoid excessive gas pressure applied to the burner during ignition and operation. Do not exceed maximum recommended drying temperatures.
- Equipment has sharp edges that can cause serious injury. To avoid injury, handle sharp edges with caution and use proper protective clothing and equipment at all times.
- All guards must be in place before and during operation. Images of guards removed in this manual are for illustration purposes only.
- Use caution when working around high-speed fans, gas burners, augers and auxiliary conveyors which can start automatically.
- Keep hands, feet, and clothing away from moving parts.
- Do not bypass any safety device or interlock.
- Do not enter the dryer or bin while it is operating.
- Do not operate in an area where combustible material will be drawn into the dryer.



ST-0029-2

1. Safety

Exercise Caution When Drying Flammable Grains

- Be aware that some grains are highly flammable including, but not limited to, rapeseed, canola, linseed, sunflower and milo.
- All grain and seed must be whole (minimal cracking or crushing), clean, and dust free before drying.
- Avoid dust and chaff from being drawn into the fan and heater.
- To reduce risk of fire, keep the fan, heater, drying plenum, and ducts clean at all times.
- In the event of a fire (or suspected fire):
 1. Shut down the entire dryer.
 2. Turn off the fuel at the tank or supply valve.
 3. Shut off and lock electrical power.
 4. Evacuate the area.
 5. Call the fire department.



ST-0032-1

Prevent Roof Damage Due to Vacuum Pressure

- Roof damage can result from excessive vacuum or internal pressure from fans or other air moving systems. The manufacturer does not warrant this type of roof damage.
- Adequate ventilation or “makeup air” devices must be provided for all powered air handling systems.
- The manufacturer does not recommend the use of downward flow systems (suction).
- Severe roof damage can result from any blockage of air passages.
- Operating fans during high humidity or cold weather conditions can cause air exhaust or intake ports to freeze.

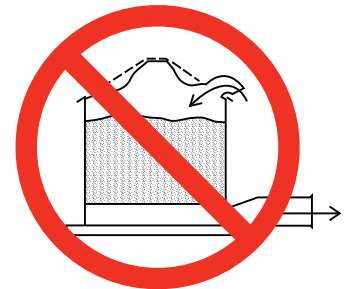

ST-0028-2

Confined Space Hazards and Entry Procedures

- Note that the interior of this equipment is considered a confined space. Maintenance of this equipment can require access to the confined space.
- Access doors must be shut and locked except when access is required.
- Doors giving access to dangerous equipment must be safety interlocked.
- The following entry procedures must be followed:
 - Be aware of all possible hazards present inside the confined space and wear personal protective equipment (PPE) as needed.
 - Complete a permit to work and follow all permit required confined space entry procedures defined by the site manager.
 - Make sure that the area has been purged of any hazardous products or gases. Check the atmosphere for harmful gases or vapors with a suitable gas analyzer and make sure levels are safe before entering.
 - Do not smoke or use naked flames.
 - Lock out and tag out power supplies and fuel supplies to all equipment.
 - Do not work alone. Work in teams of at least three so that help is immediately available in the event of an emergency.
 - Confirm that all personnel have safely exited the equipment and tools have been recovered once work is complete.



ST-0055-1

Install and Operate Gas-Fired Equipment Properly

- Gas-fired equipment should be installed by a qualified pipe fitter and must conform with local codes.
- For Canada: The equipment shall be installed in accordance with the *Natural Gas and Propane Installation Code, CSA B149.1*, or the *Propane Storage and Handling Code, CSA B149.2*, or applicable provincial regulations, which should be carefully followed in all cases. Authorities having jurisdiction should be consulted before installations are made.
- For the United States: The equipment shall be installed in accordance with the *National Fuel Gas Code ANSI Z223.1/NFPA 54*.



ST-0016-2

1. Safety

Do Not Enter Bin

- Rotating flighting will kill or dismember.
 - Flowing material will trap and suffocate.
 - Crusted material will collapse and suffocate.
- If you must enter the bin:
1. Shut off and lock out all power sources.
 2. Use a safety harness and safety line.
 3. Station another person outside the bin.
 4. Avoid the center of the bin.
 5. Wear proper breathing equipment or respirator.



ST-0061-1

2. Safety Decals



Install safety decals on components as shown in this section. Always ensure that safety decals are in a place, easily readable and in good condition. If a decal cannot be easily read for any reason or has been painted over, replace it immediately.



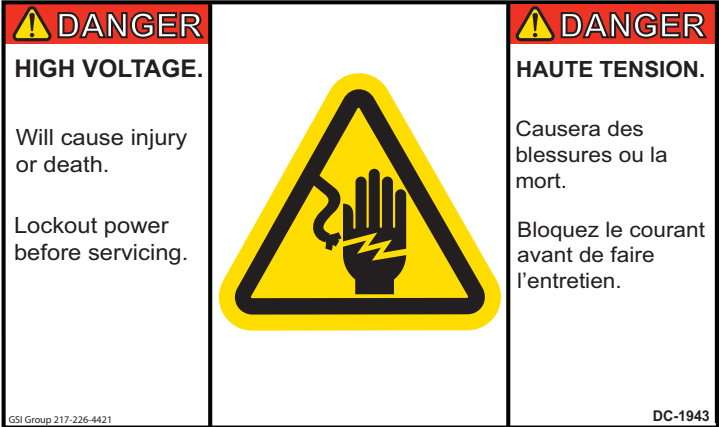

To replace a damaged or missing decal, contact us to receive a free replacement.

GSI Decals

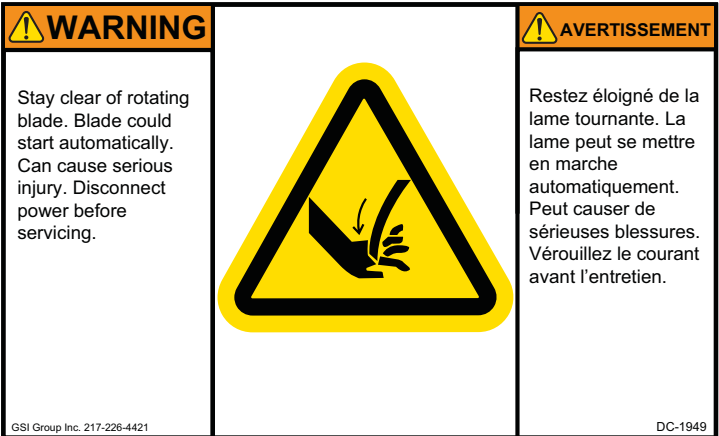
1004 E. Illinois St.
Assumption, IL 62510
Tel: 1-217-226-4421

Fan/Heater Decals

Location	Decal No.	Decals	Description
Fan/Heater Unit	DC-1943	 <p>⚠ DANGER HIGH VOLTAGE. Will cause injury or death. Lockout power before servicing.</p> <p>⚠ DANGER HAUTE TENSION. Causera des blessures ou la mort. Bloquez le courant avant de faire l'entretien.</p> <p><small>GSI Group 217-226-4421</small> <small>DC-1943</small></p>	High Voltage Danger Decal
Fan/Heater Unit	DC-1948	 <p>⚠ DANGER HIGH VOLTAGE Will cause serious injury or death. Lockout power before servicing.</p> <p>⚠ DANGER HAUTE TENSION Causera de sérieuses blessures ou la mort. Couper/verrouiller le courant avant l'entretien.</p> <p><small>GSI Group 217-226-4421</small> <small>DC-1948</small></p>	High Voltage Danger Decal
Fan/Heater Unit	DC-1949	 <p>⚠ WARNING Stay clear of rotating blade. Blade could start automatically. Can cause serious injury. Disconnect power before servicing.</p> <p>⚠ AVERTISSEMENT Restez éloigné de la lame tournante. La lame peut se mettre en marche automatiquement. Peut causer de sérieuses blessures. Verrouillez le courant avant l'entretien.</p> <p><small>GSI Group Inc. 217-226-4421</small> <small>DC-1949</small></p>	Rotating Blade Warning Decal

Location	Decal No.	Decals	Description
Fan/Heater Unit	DC-1959	<div style="display: flex; justify-content: space-between;"> <div style="width: 30%; border: 1px solid black; padding: 5px;"> <p>⚠ WARNING</p> <p>Flame and pressure beyond door can cause serious injury. Do not operate with service door removed. Keep head and hands clear.</p> <p style="font-size: small;">GSI Group 217-226-4421</p> </div> <div style="width: 35%; text-align: center;">  </div> <div style="width: 30%; border: 1px solid black; padding: 5px;"> <p>⚠ AVERTISSEMENT</p> <p>La flamme et la pression au-delà de la porte peuvent causer des dommages sérieux. Ne pas faire fonctionner si la porte de service est enlevée. Gardez les mains et la tête éloignés.</p> <p style="text-align: right; font-size: small;">DC-1959</p> </div> </div>	<p>Flame and Pressure Warning Decal</p>
Fan/Heater Unit	DC-2330	<div style="display: flex; justify-content: space-between;"> <div style="width: 30%; border: 1px solid black; padding: 5px;"> <p>⚠ WARNING</p> <p>Improper installation, adjustment, alteration, service or maintenance can cause property damage, injury or death. Read the installation, operating and maintenance instructions thoroughly before installing or servicing this equipment.</p> <p style="font-size: small;">GSI Group 217-226-4421</p> </div> <div style="width: 35%; text-align: center;">  </div> <div style="width: 30%; border: 1px solid black; padding: 5px;"> <p>⚠ AVERTISSEMENT</p> <p>Une installation, un réglage, une modification, un entretien ou une réparation incorrects peuvent entraîner des dommages, des blessures, voire la mort. Lisez attentivement les instructions d'installation, d'opération et d'entretien avant d'installer ou de réparer cet équipement.</p> <p style="text-align: right; font-size: small;">DC-2330</p> </div> </div>	<p>Read Manual Warning Decal</p>
Fan/Heater Unit	DC-2331	<div style="display: flex; justify-content: space-between;"> <div style="width: 30%; border: 1px solid black; padding: 5px;"> <p>⚠ WARNING</p> <p>The use and storage of gasoline and other flammable vapors and liquids in open containers in the vicinity of this appliance is hazardous.</p> <p style="font-size: small;">GSI Group 217-226-4421</p> </div> <div style="width: 35%; text-align: center;">  </div> <div style="width: 30%; border: 1px solid black; padding: 5px;"> <p>⚠ AVERTISSEMENT</p> <p>Il est dangereux d'utiliser ou de stocker de l'essence ou tout autre liquide ou vapeur inflammables dans des contenants ouverts à proximité de cet appareil.</p> <p style="text-align: right; font-size: small;">DC-2331</p> </div> </div>	<p>Flammable Vapor Warning Decal</p>
Fan/Heater Unit	DC-2392	<div style="display: flex; justify-content: space-between;"> <div style="width: 30%; border: 1px solid black; padding: 5px;"> <p>⚠ WARNING</p> <p>If the information in the manual is not followed exactly, a fire or explosion may result causing property damage, personal injury or loss of life.</p> <p>Do not store or use gasoline or other flammable vapors and liquids in the vicinity of this or any other appliance.</p> <p>What to do if you smell gas</p> <ul style="list-style-type: none"> - Do not try to light any appliance. - Extinguish any open flames. - Do not touch any electrical switch. - Immediately call your gas supplier. <p>Follow the gas supplier's instructions.</p> <ul style="list-style-type: none"> - If you cannot reach your gas supplier, call the fire department. <p>Installation and service must be performed by a qualified installer, service agency or the gas supplier.</p> <p style="font-size: small;">GSI Group 217-226-4421</p> </div> <div style="width: 35%; text-align: center;">  </div> <div style="width: 30%; border: 1px solid black; padding: 5px;"> <p>⚠ AVERTISSEMENT</p> <p>Si les directives du manuel ne sont pas suivies à la lettre, une explosion ou un incendie pourrait survenir et causer des dommages à la propriété, des blessures corporelles voire même la mort.</p> <p>N'entreposez pas et n'utilisez pas d'essence ni d'autres vapeurs et liquides inflammables près de cet appareil ou de tout autre appareil.</p> <p>Que faire en présence d'une odeur de gaz</p> <ul style="list-style-type: none"> - N'essayez pas d'allumer un autre appareil - Éteignez toute flamme découverte - Ne touchez à aucun interrupteur électrique - Contactez immédiatement votre fournisseur de gaz. Suivez les instructions du fournisseur de gaz. - Si vous n'êtes pas en mesure de joindre votre fournisseur de gaz, appelez les pompiers <p>L'installation et l'entretien doivent être effectués par un installateur qualifié, une agence spécialisée en entretien ou le fournisseur de gaz.</p> <p style="text-align: right; font-size: small;">DC-2392</p> </div> </div>	<p>Flammable Vapor Warning Decal</p>

3. Fuel and Electrical Specifications

TopDry CSA Heater Specifications

Model Number	Actual Maximum MBTU	Pipe Train Sub-Assembly
For Use with Natural Gas		
(2TFC, 2AFC) - 3615(1N, 3N, 5N)(M, S)	4.50	TD-101421
(2TFC, 2AFC) - 4015(1N, 3N, 5N)(M, S)	5.75	TD-101464
(2TFC, 2AFC) - 4230(3N, 5N)(M, S)	8.75	TD-101464
(2TFC, 2AFC) - 4240(3N, 5N)(M, S)	10.75	TD-101464
For Use with Liquid Propane		
(2TFC, 2AFC) - 3615(1L, 3L, 5L)(M, S)	4.50	TD-101420
(2TFC, 2AFC) - 4015(1L, 3L, 5L)(M, S)	5.75	TD-101422
(2TFC, 2AFC) - 4230(3L, 5L)(M, S)	8.75	TD-101422
(2TFC, 2AFC) - 4240(3L, 5L)(M, S)	10.25	TD-101422

TopDry CSA Orifice Chart

Fan Size	Pipe Train Assembly Part #	Orifice Number	Fuel Type	BTU
3615	TD-101441	CD-0150 (0.328)	LP	4.50
3615	TD-101443	D04-0563 (0.422)	NG	4.50
4015	TD-101442	THF-3058 (0.344)	LP	5.75
4015	TD-101444	THF-3246 (0.516)	NG	5.75
4230	TD-101442	THF-3059 (0.438)	LP	8.75
4230	TD-101444	THF-3251 (0.594)	NG	8.75
4240	TD-101442	THF-3252 (0.453)	LP	10.25
4240	TD-101444	D04-0569 (0.719)	NG	10.25

The electrical supply must be capable of the full demand from the dryer, including aeration fan, fill and empty equipment and start currents.

For twin fan units, double the minimum demand.

Allow for fill and empty equipment loads.

Machine to Earth Connection

The dryer must be connected to earth.

In most cases this will be via the earth supply provided with the power supply.

Where no earth is supplied or for generator supplies, a ground rod must be used. This must be selected and installed by a qualified engineer, in accordance with EU Directives and/or Local Regulations and Codes.

Emergency Stop

The dryer is fitted with an emergency stop.

It is recommended that auxiliary fill and empty equipment be installed so that in the event of an emergency stop, all equipment is stopped.

This is the responsibility of the installer.

5. Heater Wiring Diagrams

Series 2000 TopDry CSA Master

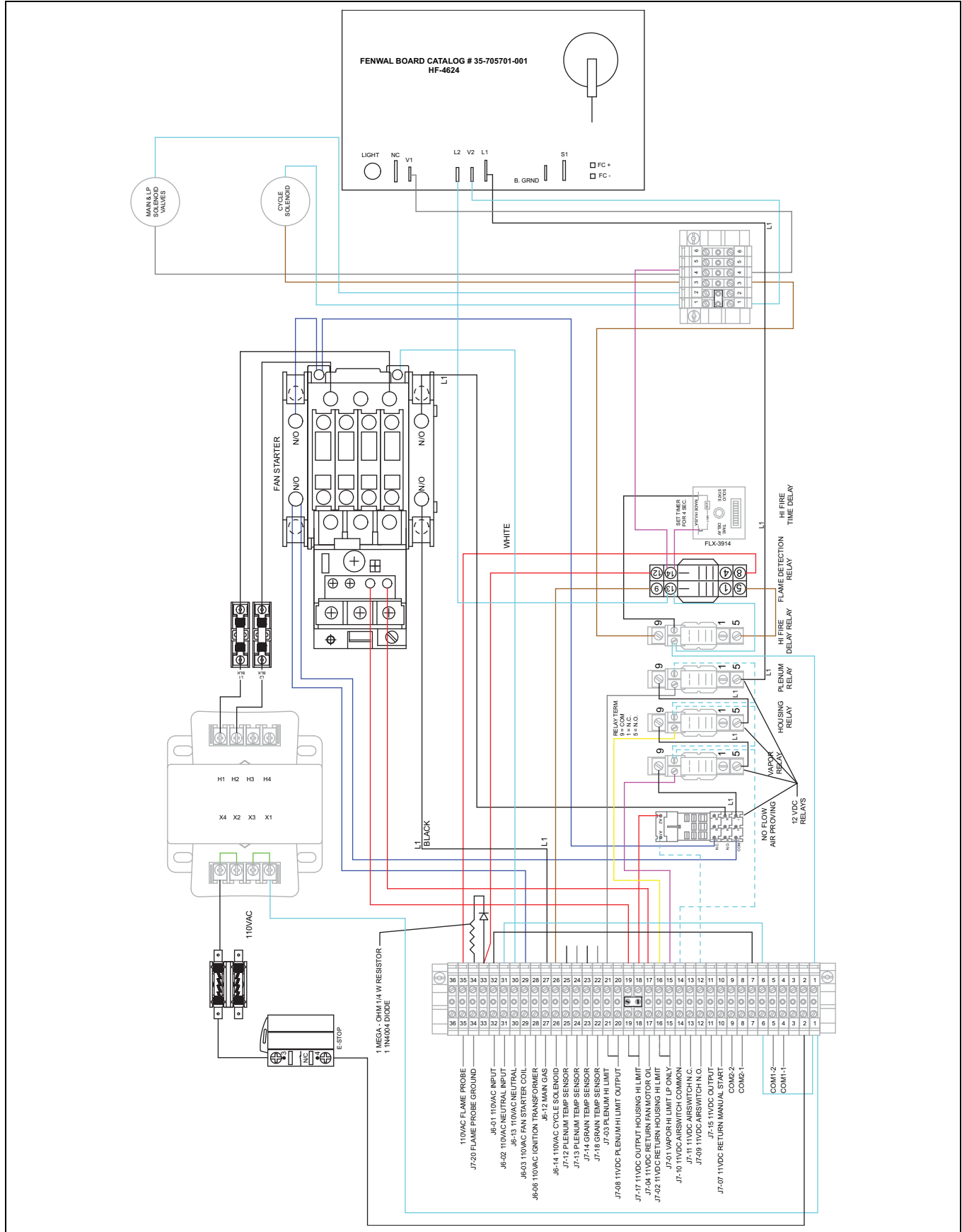

Series 2000 TopDry CSA Slave

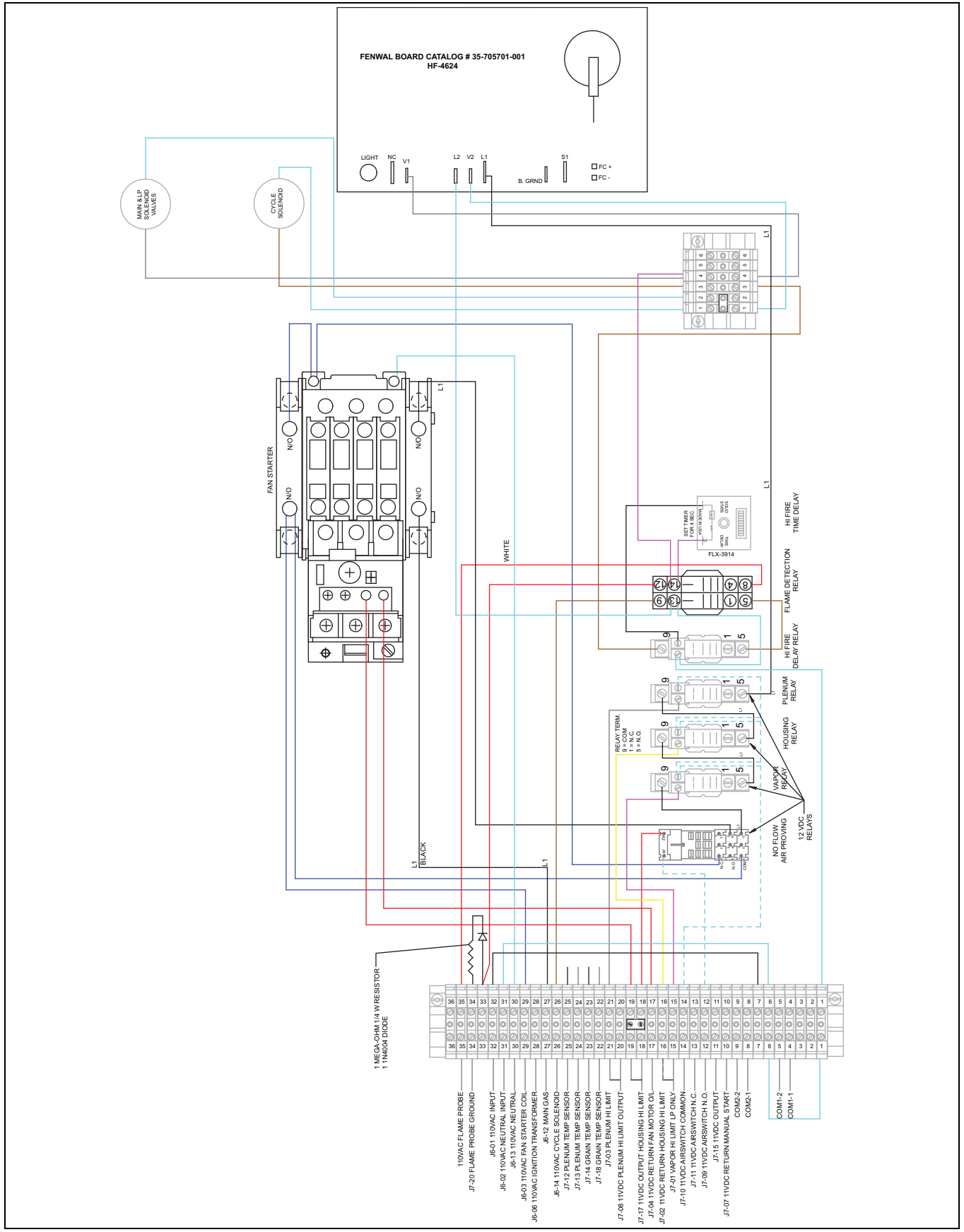

5. Heater Wiring Diagrams

Ladder Logic Diagrams for TopDry CSA Master and Slave

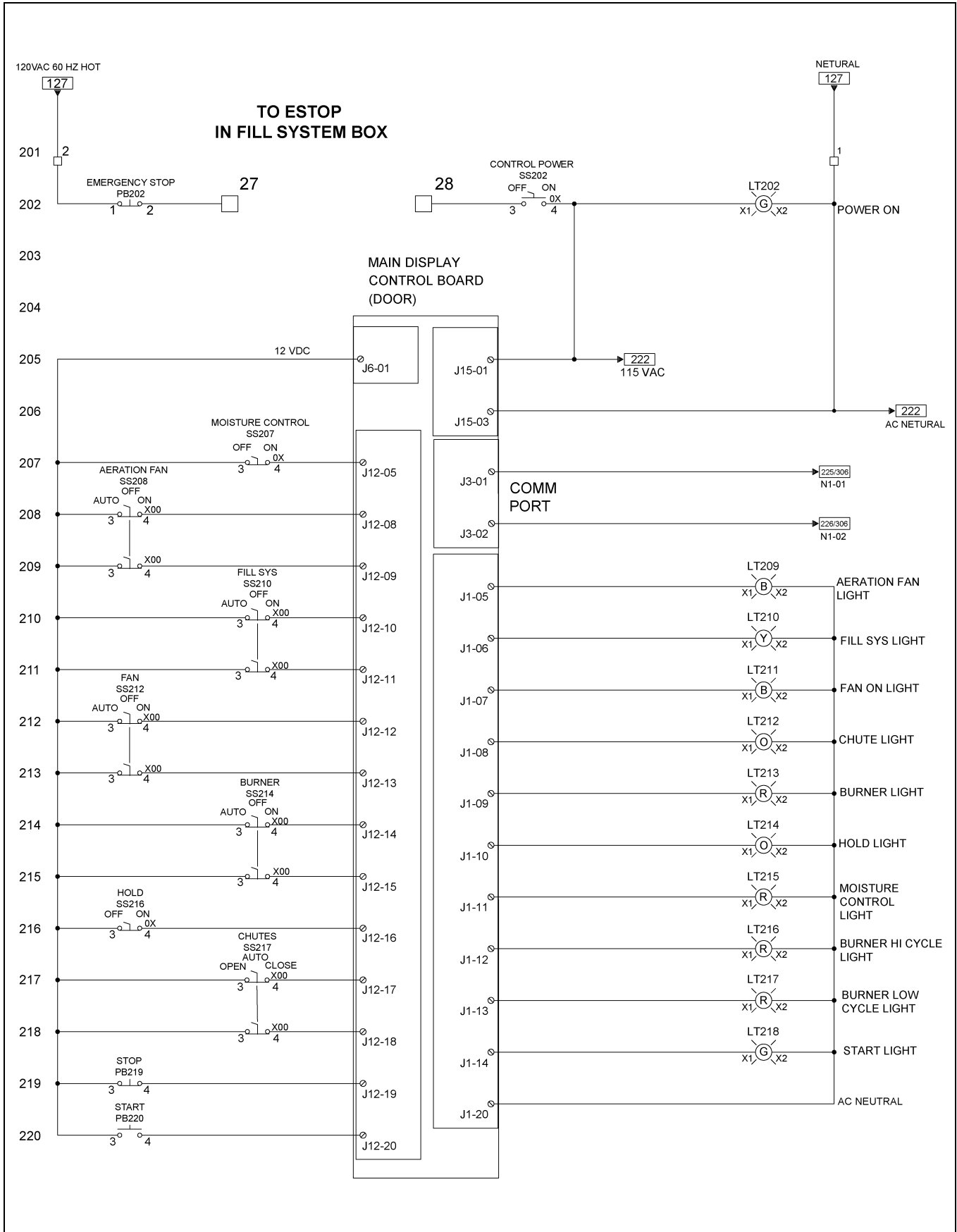

Ladder Logic Diagrams for TopDry CSA Master and Slave (Continued)

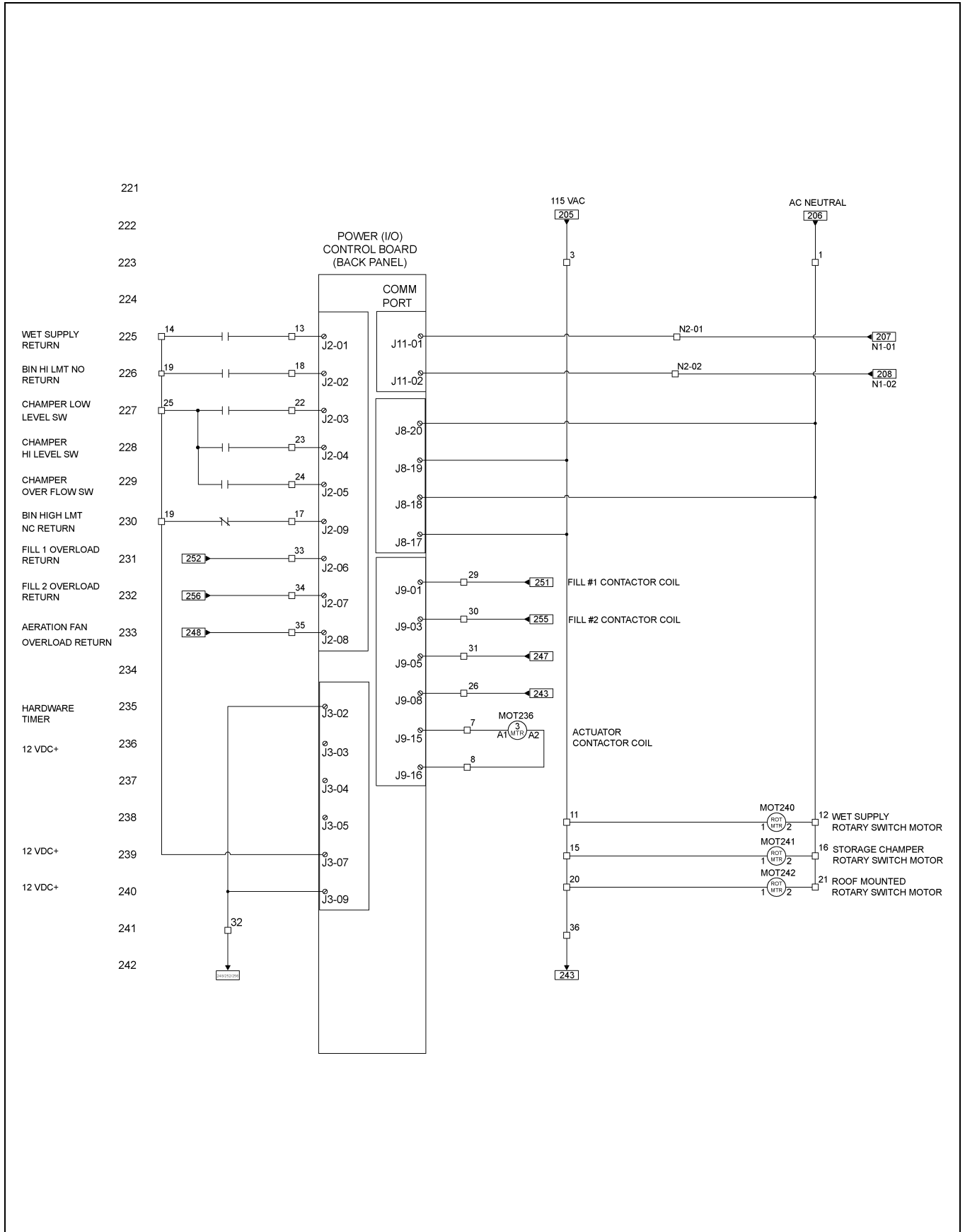

5. Heater Wiring Diagrams

Ladder Logic Diagram for TopDry Fill System

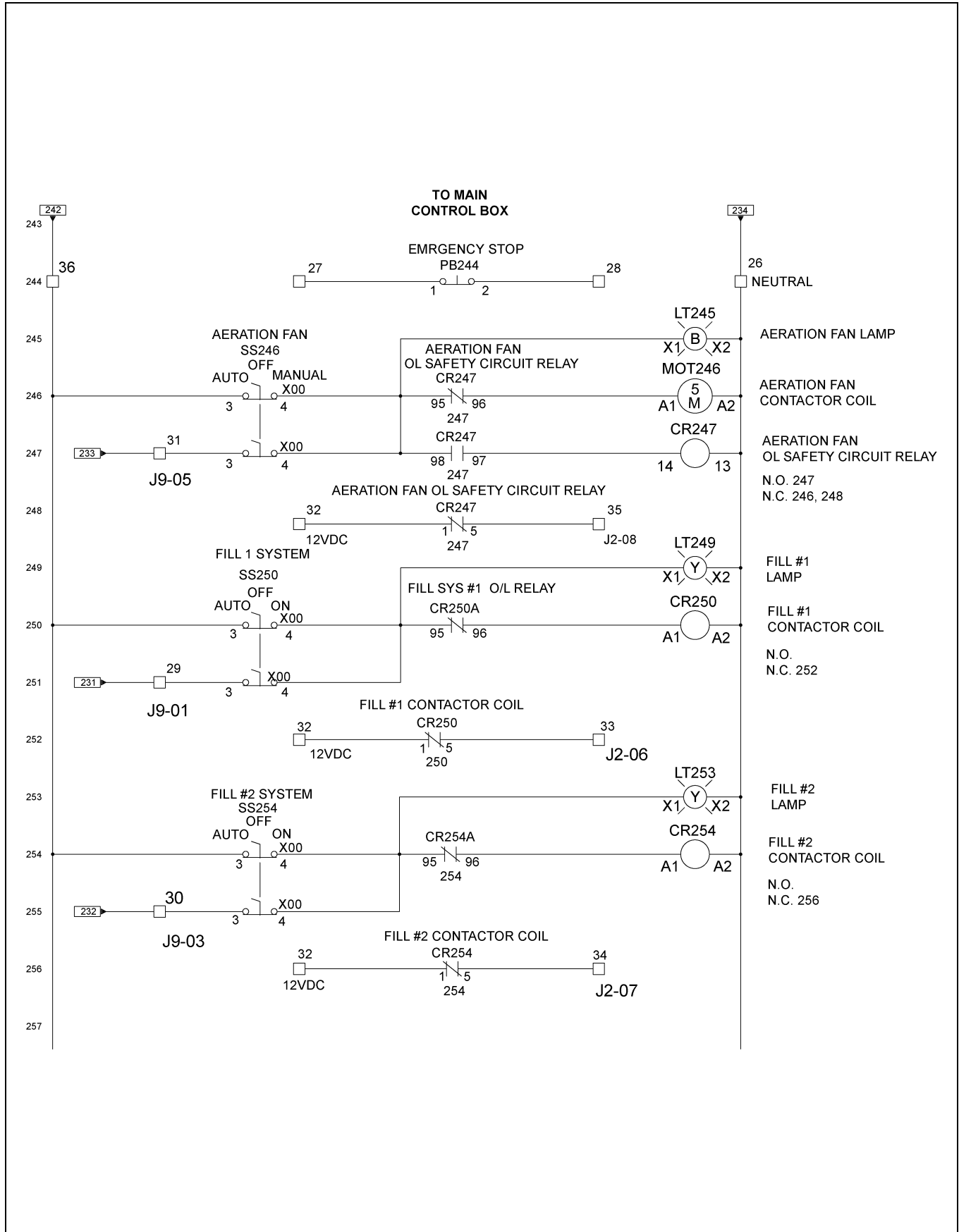

Dryer Global State

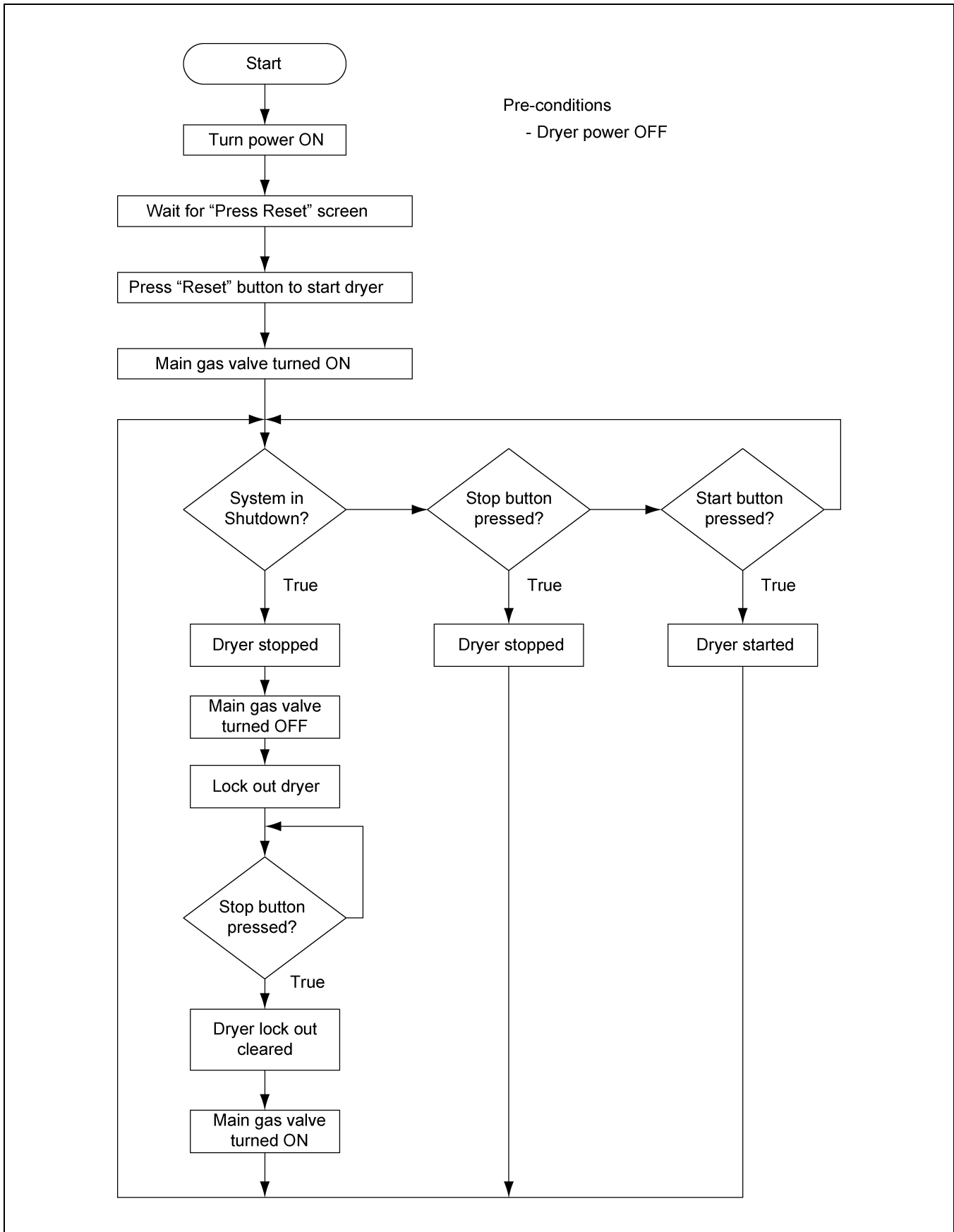

Fill Sub-System Operation

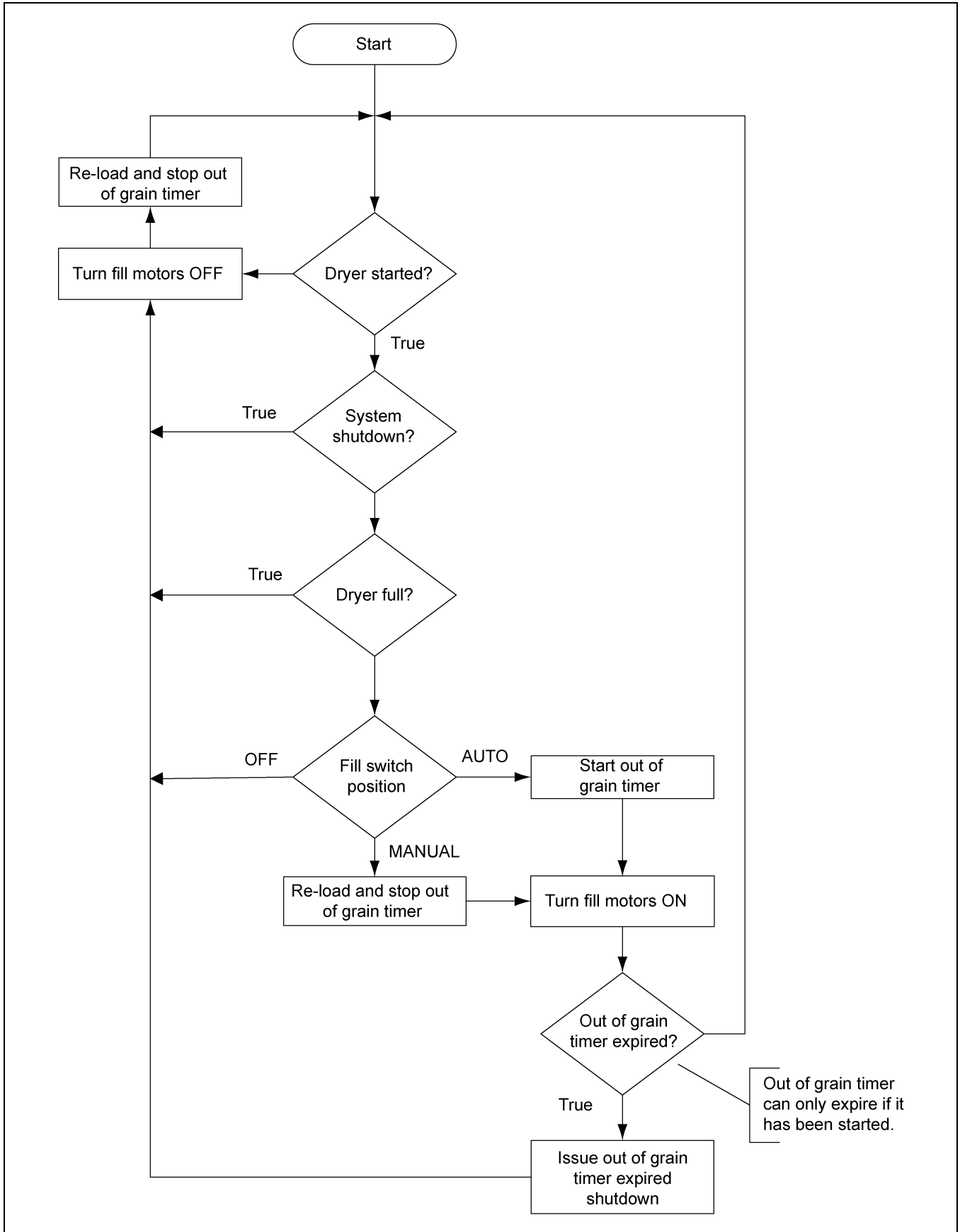

Dump Sub-System Operation

Pre-conditions:

- Dump switch is in AUTO position.

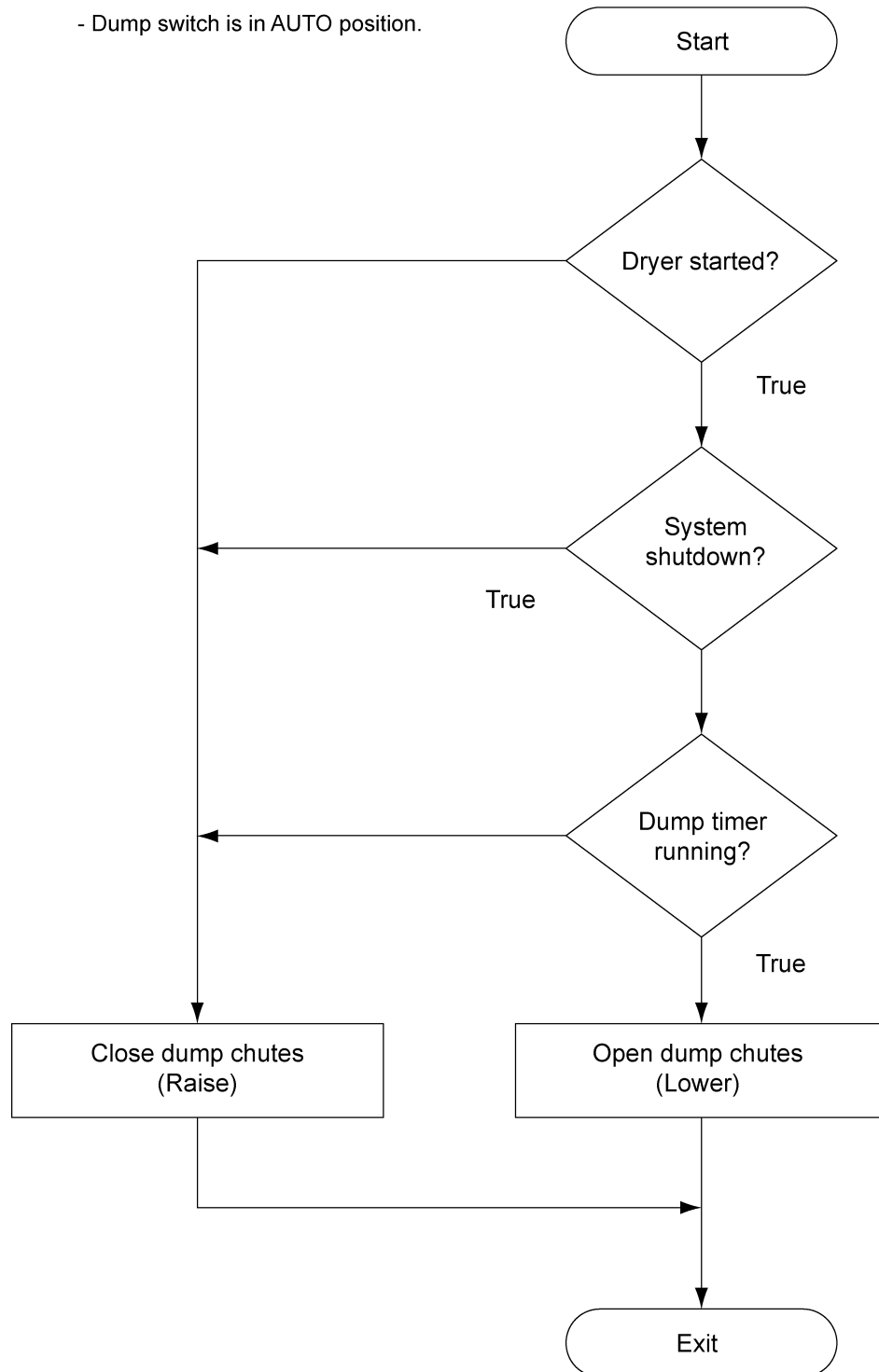

Fan-Heater Sub-System Operation

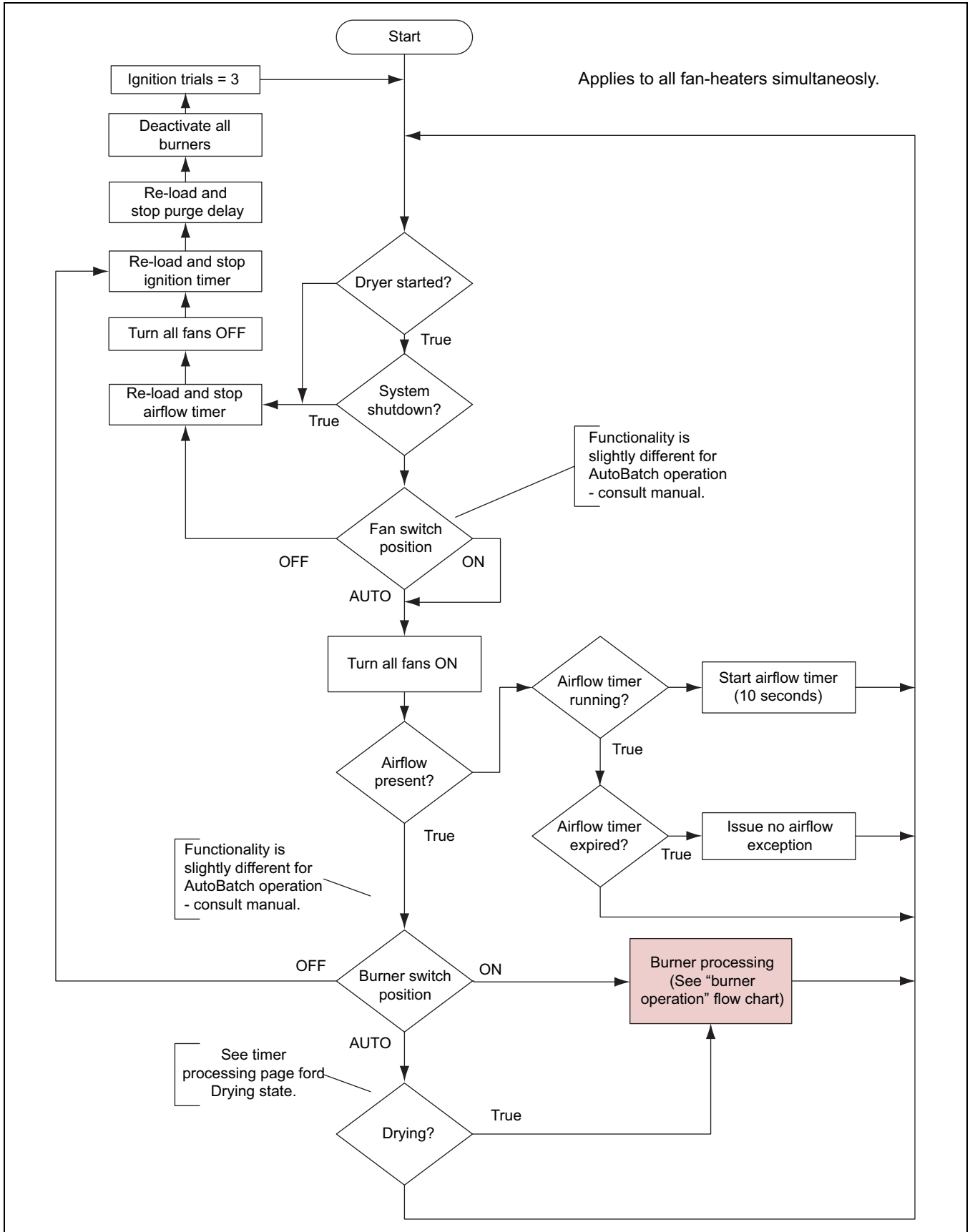

Burner Operation

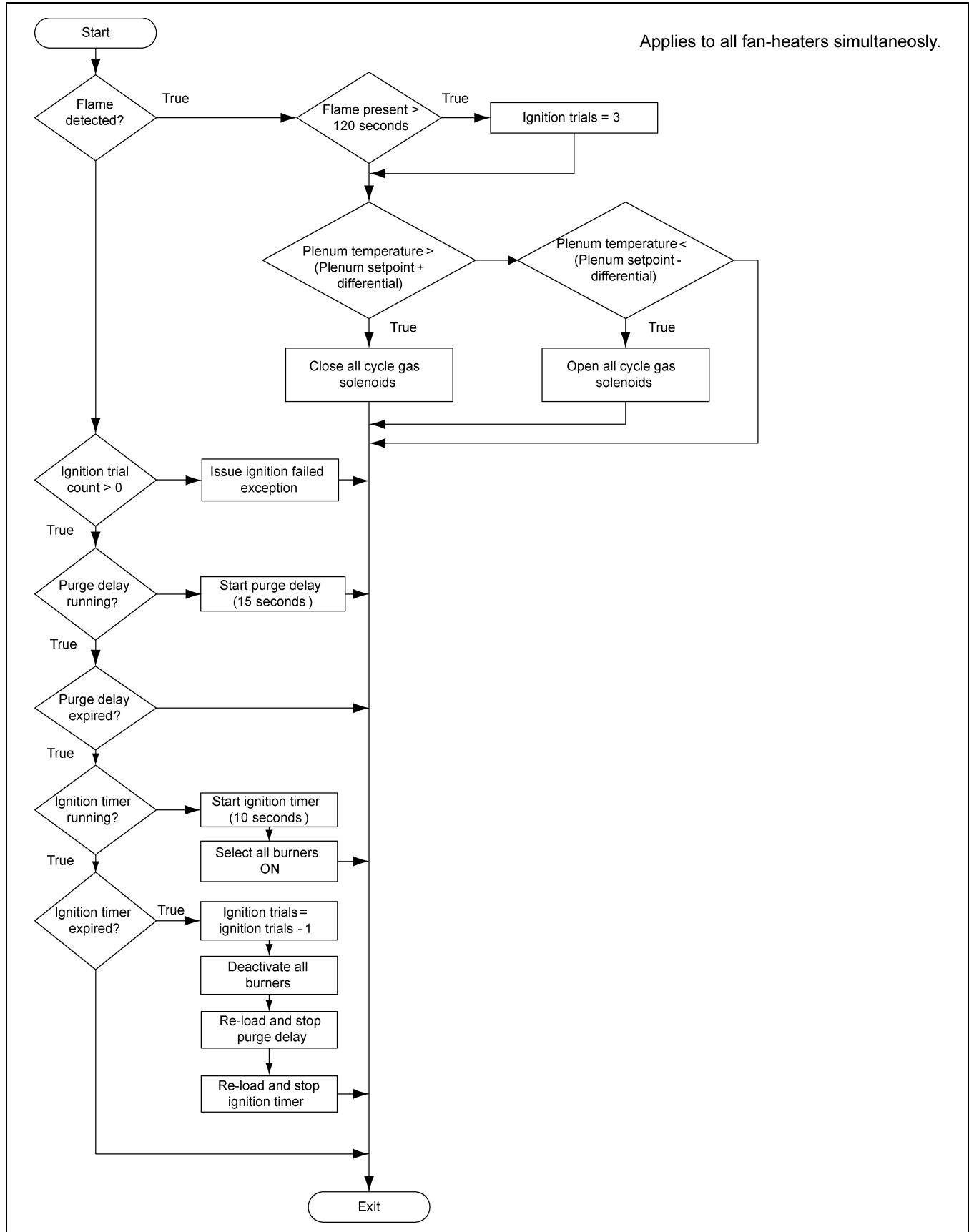

Process Timer Operation

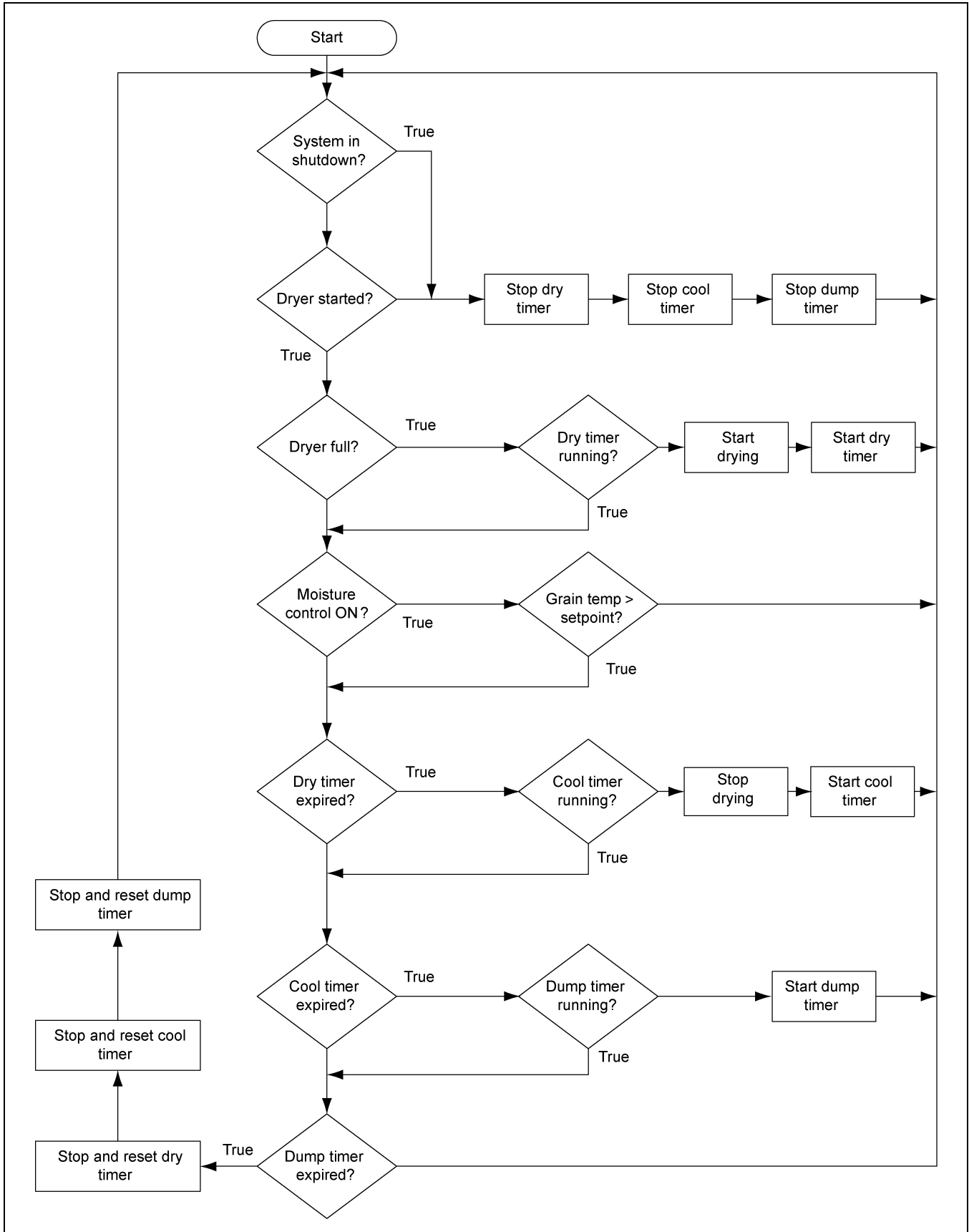

Fuel Connection

IMPORTANT: *Do not use propane tanks that have previously been used for ammonia unless they have been purged according to procedures of the National LP association.*

Fuel supply system must comply with local codes for LP gas installation.

Dryer/heater and individual shut off valve must be disconnected from the gas supply piping system during any pressure testing of the system at test pressures in excess of 1/2 PSI. The dryer/heater must be isolated from the gas supply piping by closing its individual manual shut off valve during any pressure testing of the gas supply piping system at test pressures equal to or less than 1/2 PSI.

Refer to the dryer/heater rating plate for determining the minimum gas supply pressure for obtaining the maximum gas capacity for which this dryer is specified.

The equipment shall be installed in accordance with the Natural Gas and Propane Installation Code, CSA B149.1 and the Propane Storage and Handling Code, CSA B149.2 or applicable provincial regulations, which should be carefully followed in all cases. Authorities having jurisdiction should be consulted before installations are made. Bleeds and vents that require venting by authorities having jurisdiction shall be vented away from any sources of ignition by the gas piping installer. The installer shall also locate a manual emergency shut off valve in an appropriate location that allows access to the valve to shut off the fuel to the dryer in case of a fire or explosion at the dryer.

Liquid LPG

Dryers with internal vaporizers require LPG in liquid form.

Vapor LPG

Dryers without internal vaporizers require LPG in vapor form.

Primary pressure regulation is required at the tank, including over pressure protection.

Supply pressure at the dryer should be at least 15 PSI.

Natural Gas

Natural gas dryers require a supply pressure of 10 PSI.

Primary pressure regulation should include over pressure protection.

NOTES

1. 36" Pipe Train Sub-Assembly - LP CSA (TD-101420) - [\(See Pages 32-33.\)](#)
2. 36" Pipe Train Sub-Assembly - NG CSA (TD-101421) - [\(See Pages 34-35.\)](#)
3. 40" and 42" Pipe Train Sub-Assembly - LP CSA (TD-101422) - [\(See Pages 36-37.\)](#)
4. 40" and 42" Pipe Train Sub-Assembly - NG CSA (TD-101464) - [\(See Pages 38-39.\)](#)
5. LP Supply Pipe Train (TD-101445) - [\(See Page 40.\)](#)

36" Pipe Train Sub-Assembly - LP CSA (TD-101420)

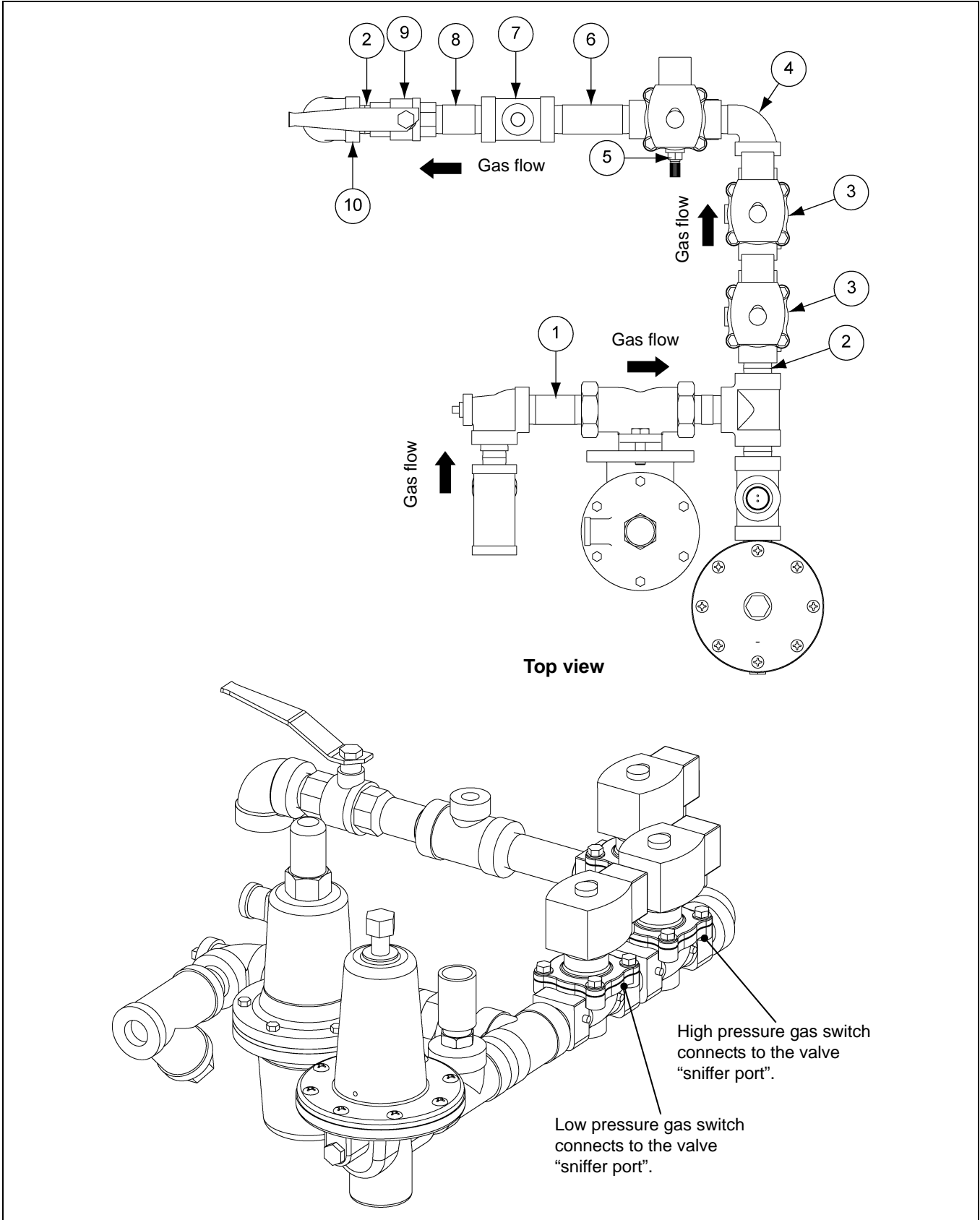

Figure 8A 36" LP Pipe Train

36" Pipe Train Sub-Assembly - LP CSA (TD-101420) Parts List

Ref #	Part #	Description	Qty
1	TD-101424	Pipe Train, LP Regulator Assembly, 36" - CSA	1
2	THH-4121	Nipple, 3/4" Close SCH 40 Black	4
3	056-2223-8	Valve, Solenoid 3/4" NPT 115V Din 50 PSI Max	2
4	THH-4066	Elbow, 3/4"-90° Street SCH 40 Black	1
5	056-2228-7	Valve, Solenoid 3/4" NPT 115V Din Bypass 30 PSI Max	1
6	HH-6332	Nipple, 3/4" x 3-3/4" SCH 40 Black	1
7	THH-4154	Tee, 3/4" x 3/4" x 1/4" SCH 40 Black	1
8	HH-7102	Nipple, 3/4" x 2-3/4" SCH 40 Black	1
9	D03-0837	Valve, Solenoid 3/4" NPT Full Port, Lever, CSA, Brass	1
10	THH-4120	Elbow, 3/4"-90° SCH 40 Black	1

36" Pipe Train Sub-Assembly - NG CSA (TD-101421)

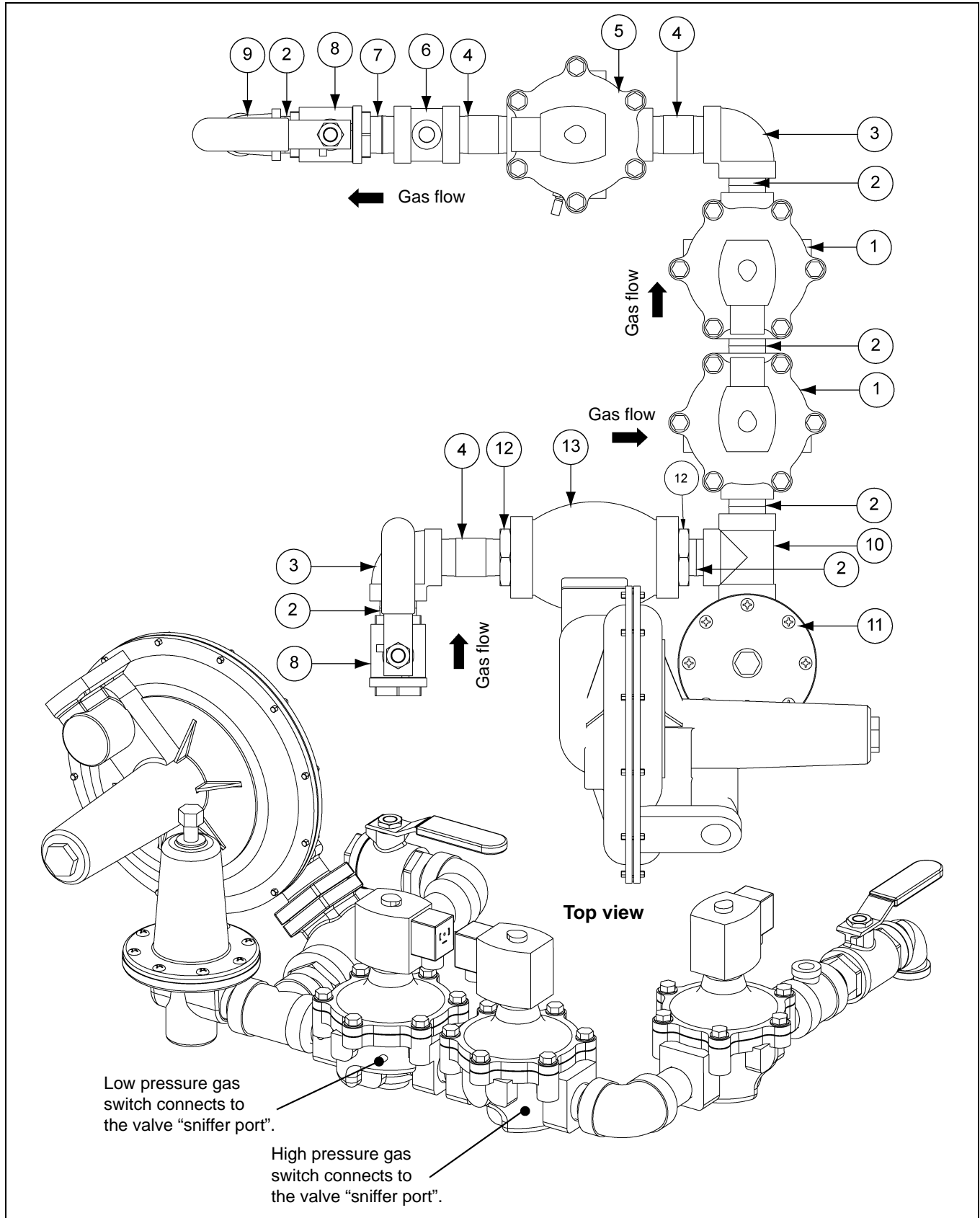

Figure 8B 36" NG Pipe Train

36" Pipe Train Sub-Assembly - NG CSA (TD-101421) Parts List

Ref #	Part #	Description	Qty
1	056-2224-6	Valve, Solenoid 1" NPT 115V Din 25 PSI Max ASCO Rebuild Kit #31891	2
2	THH-4117	Nipple, 1" Close SCH 40 Black	7
3	THH-4115	Elbow, 1"-90° SCH 40 Black	2
4	THH-4151	Nipple, 1" x 3" SCH 40 Black	3
5	056-2230-3	Valve, Solenoid 1" NPT 115V Din with Bypass 30 PSI	1
6	THH-4152	Tee, 1" x 1" x 1/4" SCH 40 Black	1
7	007-1242-2	Nipple, 1" x 2" SCH 40 Black	1
8	D03-0838	Valve, Solenoid 1" NPT Full Port, Lever, CSA, Brass	2
9	007-1307-3	Elbow, 1" to 3/4"	1
10	THH-4137	Tee, 1" x 1" x 1" SCH 40 Black	1
11	D03-0881	Valve, Solenoid Relief - 15-50 PSI Spring LP, 1" NPT	1
12	D08-0007	Reducer, 1-1/2" x 1" Hex Bushing	2
13	D03-1163	Regulator, 1-1/2" NPT, Sensus, NG, 2-4.5 PSI	1

40" and 42" Pipe Train Sub-Assembly - LP CSA (TD-101422)

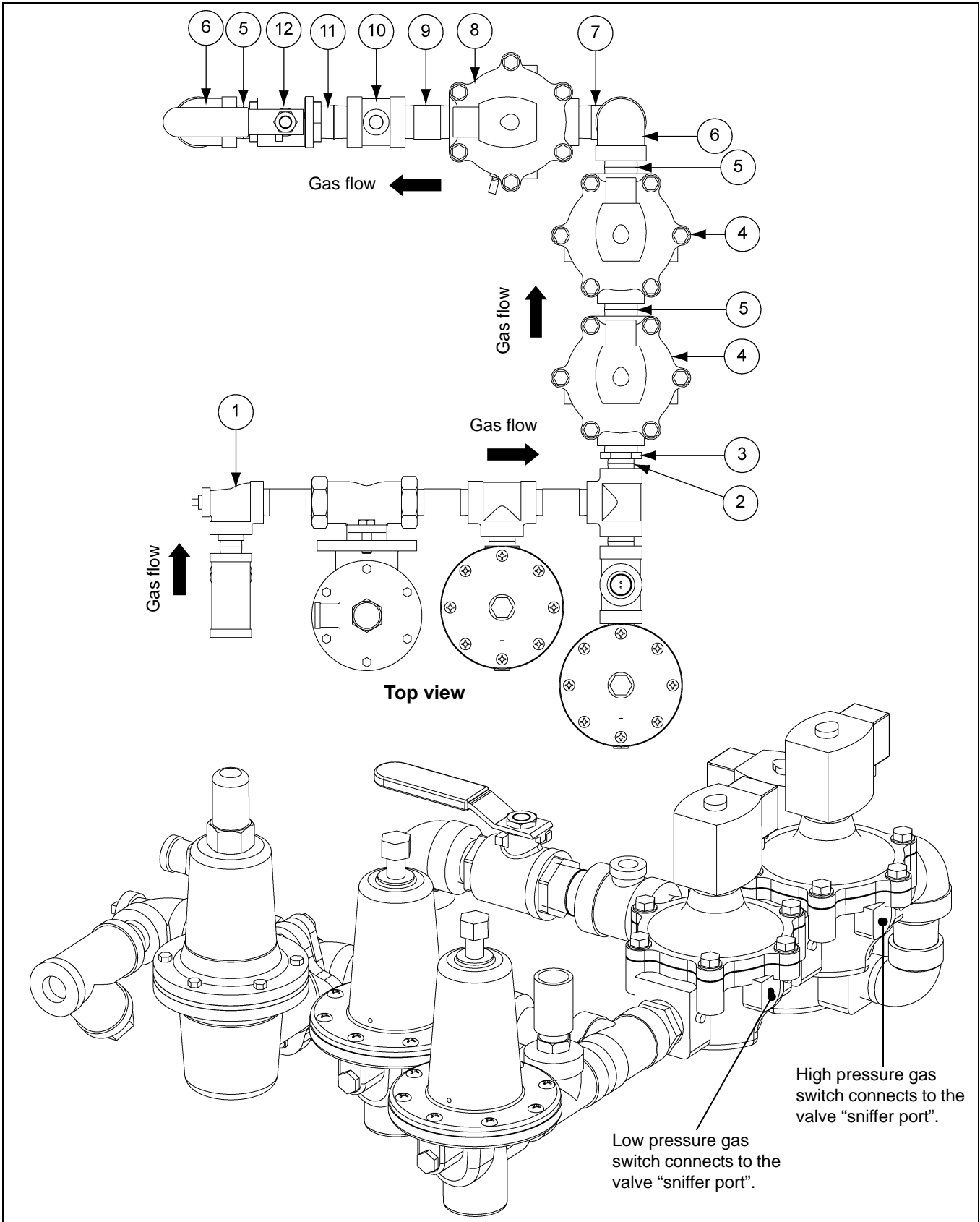

Figure 8C 40" - 42" LP Pipe Train

40" and 42" Pipe Train Sub-Assembly - LP CSA (TD-101422) Parts List

Ref #	Part #	Description	Qty
1	TD-101466	Pipe Train, LP Regulator Assembly, 40" and 42" - CSA	1
2	THH-4121	Nipple, 3/4" Close SCH 40 Black	1
3	D08-0003	Reducer Bushing 1" x 3/4" Hex	1
4	056-2224-6	Valve, Solenoid 1" NPT 115V Din 25 PSI Max ASCO Rebuild Kit #31891	2
5	THH-4117	Nipple, 1" Close SCH 40 Black	4
6	THH-4115	Elbow, 1"-90° SCH 40 Black	2
7	THH-4164	Elbow, 1-90° Street SCH 40 Black	1
8	056-2230-3	Valve, Solenoid 1" NPT 115V Din with Bypass 30 PSI	1
9	THH-4151	Nipple, 1" x 3" SCH 40 Black	1
10	THH-4152	Tee, 1" x 1" x 1/4" SCH 40 Black	1
11	007-1242-2	Nipple, 1" x 2" SCH 40 Black	1
12	D03-0838	Valve, Solenoid 1" NPT Full Port, Lever, CSA, Brass	1

8. Pipe Train Assembly

40" and 42" Pipe Train Sub-Assembly - NG CSA (TD-101464)

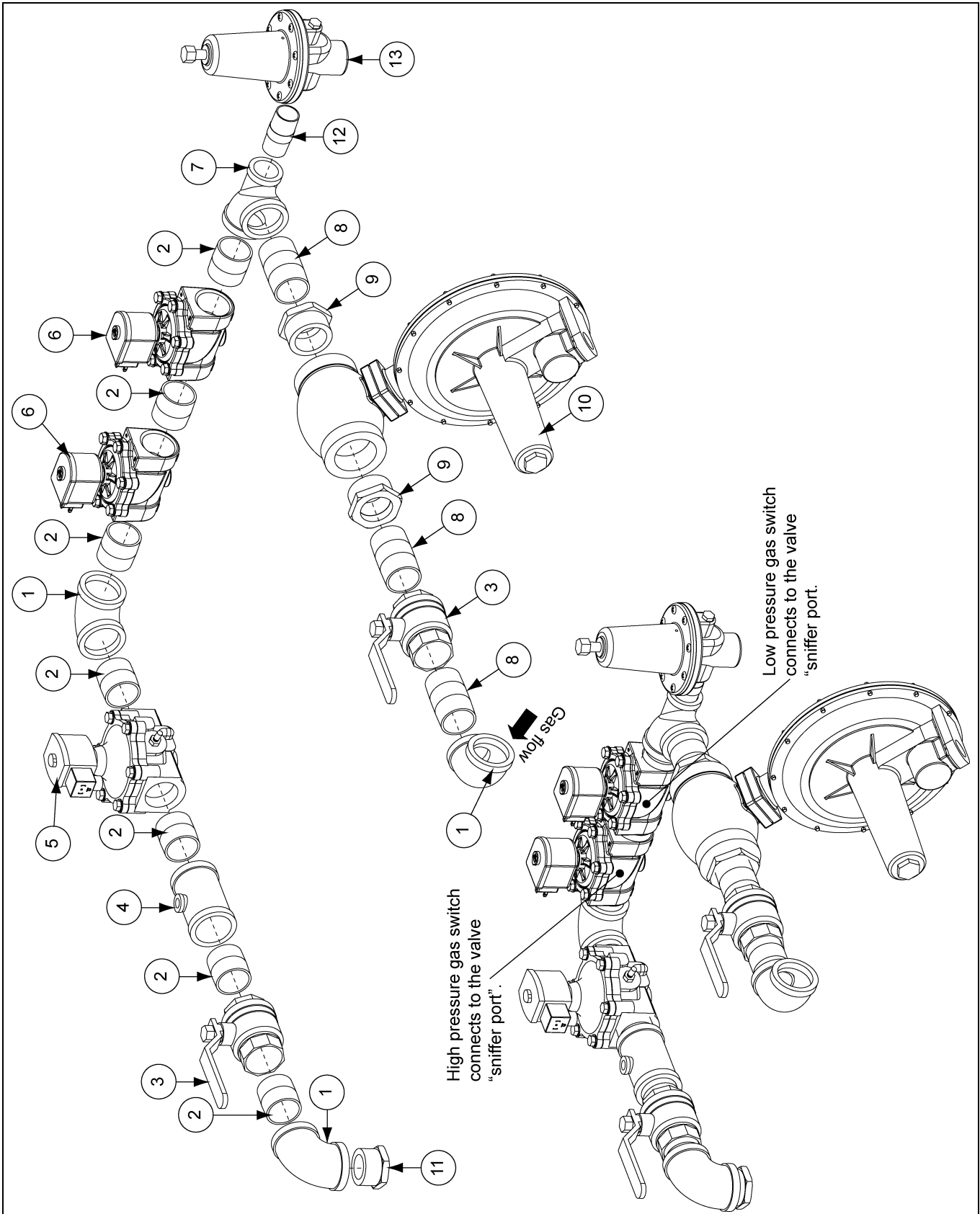

Figure 8D 40" - 42" NG Pipe Train

40" and 42" Pipe Train Sub-Assembly - NG CSA (TD-101464) Parts List

Ref #	Part #	Description	Qty
1	D08-0011	Elbow, 1-1/2" -90 SCH 40 Black	3
2	D08-0009	Nipple, 1-1/2" Close SCH 40 Black	7
3	D08-0008	Valve, 1-1/2" NPT B-Cock Shut Off Brass or Bronze	2
4	TF-1710	Tee, 1-1/2" x 1-1/2" x 1/4" SCH 40 Black	1
5	GT3-1127	Valve, Solenoid 1-1/2" NPT 115V Din with bypass	1
6	D03-1269	Valve, Solenoid 1-1/2" ASCO w/ Din	2
7	D03-0445	Tee, 1-1/2" x 1-1/2" x 1" SCH 40 Black	1
8	D08-0013	Nipple, 1-1/2" x 3" SCH 40 Black	3
9	GT3-0390	Reducer, Hex 2 x 1-1/2" Black	2
10	D03-1164	Regulator, 2" NPT, Sensus, NG, 2 - 4-1/2 PSI	1
11	D08-0007	Reducer, 1-1/2" x 1" Hex Bushing	1
12	THH-4037	Nipple, 1" x 2-1/2" SCH 40 Black	1
13	D03-0820	Valve, Relief - 10-20 PSI Spring NG, 1" NPT	1

8. Pipe Train Assembly

LP Supply Pipe Train (TD-101445)

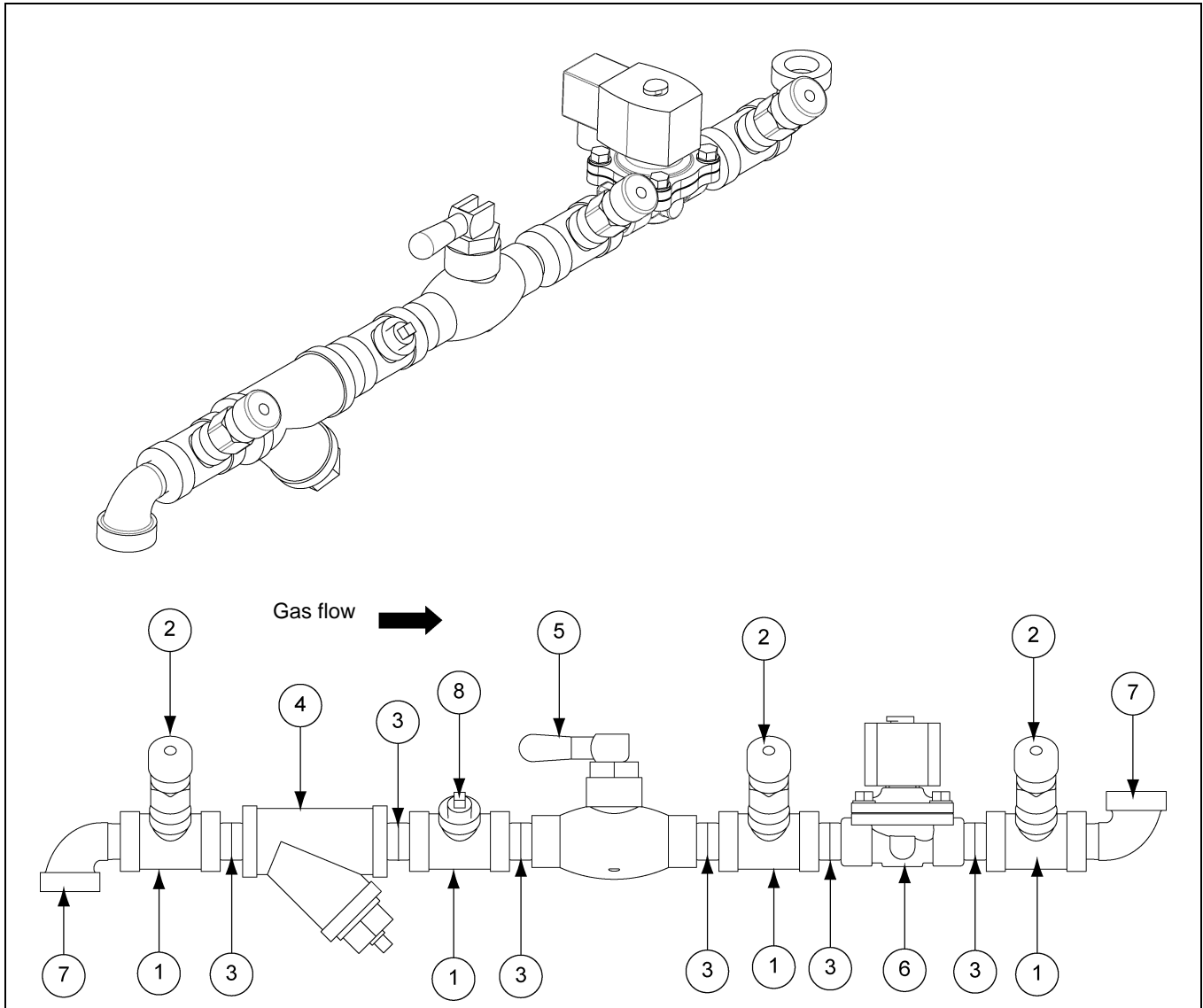

Figure 8E LP Supply Pipe Train

LP Supply Pipe Train (TD-101445) Parts List

Ref #	Part #	Description	Qty
1	HH-4846	Tee, 1/2" x 1/2" x 1/4" SCH 80 Black	4
2	031-1008-7	Valve, Solenoid Pressure Relief 300PSI	3
3	D07-0019	Nipple, 1/2" x 1-1/2" SCH 80 Black	6
4	HH-1251	Strainer, 1/2" Y 250# WOG SCH 80 Black	1
5	D03-0840	Solenoid Valve, 1/2NPT LP Quick Shut-off CSA	1
6	TFC-0092	Valve, 1/2" NPT Solenoid LP	1
7	HH-1082	Elbow, 1/2"-90° Street SCH 80 Black	2
8	007-1747-0	Plug, 1/4" NPT Square Black	1

Dryer Control Panel



Figure 9A

Moisture Control Switch

Determines if the grain temperature set point is used in the operation of the dryer.

When "ON" position, the grain will be dumped when it reaches the temperature set point and the dry timer has reached zero.

When "ON" the switch is lit when the grain is below set point.

Control Power Switch

Turns ON/OFF power to the electronic monitoring control system.

Aeration Fan Switch

Controls the operation of the aeration fan located at the bottom of the bin.

AUTO = Fan runs only with the main drying fans.

ON = Fan comes on when the dryer is running.

9. Control Panel

Load Auger Switch

Controls the operation of the drying chamber fill system(s).

Switch is lit when the fill system(s) are running.

AUTO = Fill system(s) start and stop automatically depending level of grain in drying chamber. When operating in the Autobatch mode the fill system(s) will shut off 2/3 of the way through the dry cycle regardless of drying chamber level.

ON = Fill system(s) are ON when the dryer is running.

Fan Switch

Controls the operation of the main drying fan(s).

Switch is lit when airflow is sensed.

AUTO = Main drying fan(s) start when drying chamber is full.

ON = Main drying fan(s) come ON and stay ON when the dryer is running.

Heater Switch

Controls the operation of the burner(s).

Switch is lit when the burner is ON.

Small lights above and below the heater switch indicate if the burner(s) are in high-fire or low-fire.

AUTO = Burner(s) light when drying chamber is full remain on until the dryer shuts down or is stopped.

ON = Burner(s) light anytime the main drying fan(s) are running.

Dump Switch

Controls the operation of the drying chamber dump chutes.

Switch illuminate when the chutes are moving.

MANUAL CLOSE = Chutes close.

AUTO = Chutes automatically dump at the end of the drying cycle.

MANUAL OPEN = Chutes open (dump).

NOTE: *Manual open and close only operate when the dryer Stop button has been pressed.*

Dry and Hold Switch

When ON the normal dump cycle will be inhibited at the end of the dry cycle.

Dryer Power Start Switch

Starts the dryer.

Lit up when dryer is running.

Dryer Power Stop Switch

Stop the dryer.

Also used to reset after an error or fault.

Electronic Monitoring Control System

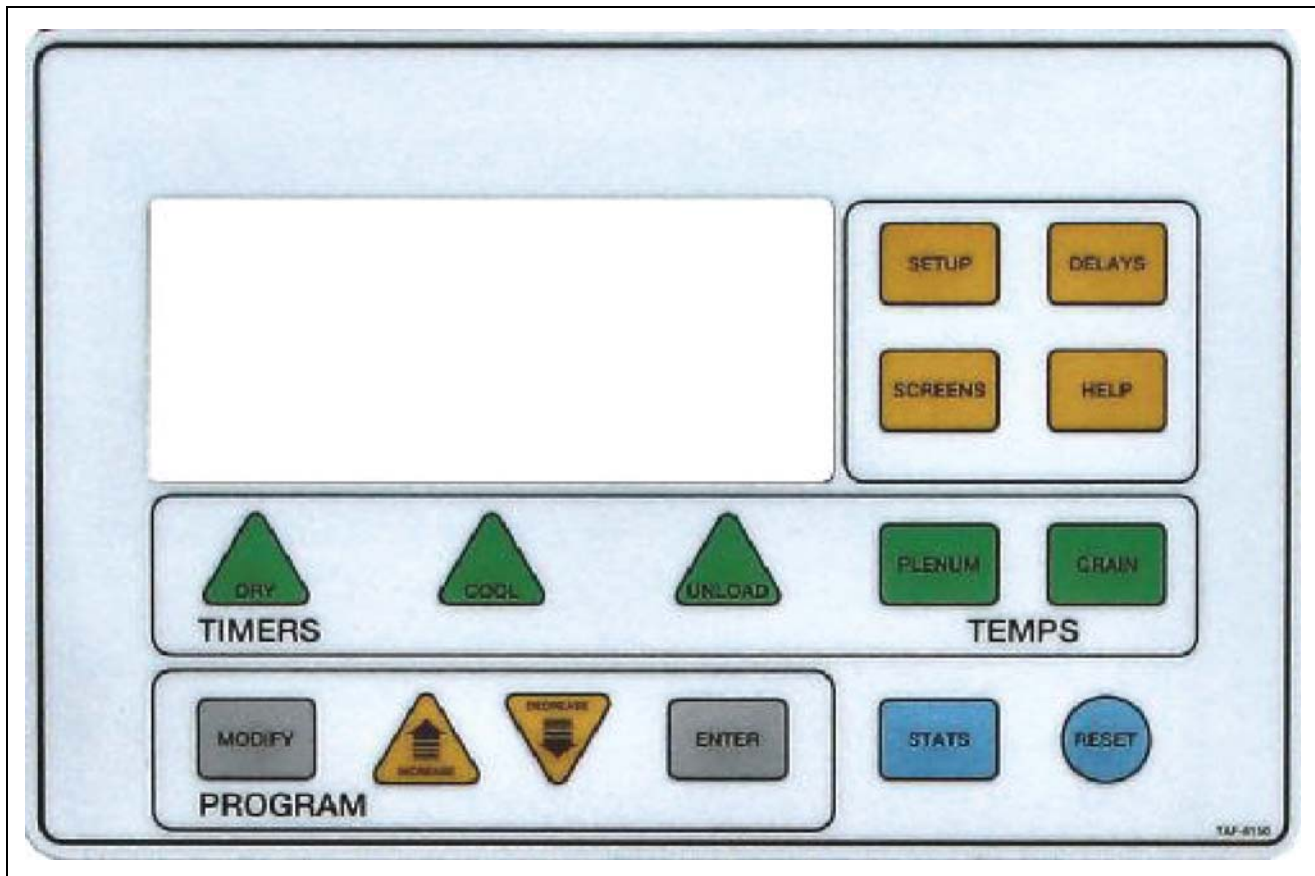

Figure 10A

Electronic Monitoring Control System

This controls all timing functions and safety circuits. It provides printed messages and warnings.

Turn control power to “ON” to start the control. The control will enter the main drying screen.

Setting the Dry, Cool and Unload Timers

These set the dry, cool and dump cycle times. The timer settings are displayed above the Timer button. To alter the setting:

1. Press the Dry, Cool or Unload Timer button.
2. Press “modify”.
3. Press “increase” or “decrease” to adjust the settings.
4. Press “enter”.
5. To enter the new value into memory, press “reset”.

During drying the remaining time for each timer is displayed. The control retains these values in the event of a power failure. Pressing “reset” returns the timers to their initial setting. The cool timer is not used in an Autoflow system.

10. Control System

Setting the Delays

The following timers are set using the same procedure, but the Reset button does not need to be pressed to enter the new values into memory immediately.

AUX. 1 DELAY - Not used.

REFILL DELAY - Used only on batch units. This delays the start of drying to allow the drying chamber to fill. If the unit does not refill within this time the unit will give a “dry chamber empty” error.

FILL #1 DELAY - This timer keeps the fill system running for a period of time after the Drying Chamber switch has detected grain. The purpose is to eliminate rapid start/stop in the fill system. Set the timer so that grain covers the Upper Level switch, but does not reach the Chamber Overflow switch.

If the Autoflow controls two (2) fill systems, this timer keeps fill system #1 running after fill system #2 has stopped. (Fill system #1 is the system the delivers direct to the drying chamber.) Set the time to completely empty fill system #1, but should not allow grain to reach the Chamber Overflow switch.

FILL #2 DELAY - This timer is used where two (2) fill systems are controlled. It keeps fill system #2 running for a period of timer after the Drying Chamber Upper Level switch has detected grain. Set the timer so that grain covers the Upper Level switch, but does not reach the Chamber Overflow switch.

OUT OF GRAIN DELAY - This allows the dryer to continue running for a period of time after the Drying Chamber Low Level switch has detected no grain. This stops nuisance shut downs. Once the out of grain timer has elapsed the dryer will shut down and report “no grain”. If you are getting “no grain” shut downs, increase the timer.

FAN DELAY - Used only on twin fan units to delay the start of the second (slave) fan. Recommended setting is 3 seconds.

FANS OFF DELAY - Allows the fans to be stopped during the dump cycle. Options are 1.00 (ON) and 0.00 (OFF). When ON the fans will stop during the dump cycle and restart following.

Standard Setup

The setup mode is used to program the computer with different variables that influence how the dryer will operate.

CLEAR TOTAL BATCHES - Press the Reset button to clear the total batches. Press the Enter button to continue.

CLEAR WARNING HISTORY - Press the Reset button to clear the warning history. Press the Enter button to continue.

TIME UNTIL LOAD OFF - In Autobatch mode is the percentage of time through the dry cycle that the fill systems will be shut off regardless if the dryer is full or not. Press the Enter button to return to the main drying screen.

Extended Setup

SET DATE -

SET MONTH -

SET YEAR -

SET HOUR -

SET MINUTE -

Use the Increase and Decrease buttons to select the correct time or date. Press the Enter button to accept.

LOW LEVEL TEST MODE - Use the Increase and Decrease buttons to enable or disable Drying Chamber Low Level switch monitoring.

WET TANK TEST MODE - Use the Increase and Decrease buttons to enable or disable wet supply level switch monitoring.

START FANS WITH HIGH - Use the Increase and Decrease buttons to enable or disable fan starting based on the Upper Drying Chamber Level switch. Recommended practice is fans starting with the Drying Chamber Low Level switch.

AERATION FAN BYPASS - Use the Increase and Decrease buttons to enable or disable. When enabled the fan runs after the dryer stops.

OF FILL SYSTEMS - Use the Increase and Decrease buttons to select one or two (2) fill systems under dryer control. Note setting of fill #1 and fill #2 system timers [on Page 46](#).

SELECT DRYER TYPE - Use the increase and decrease select dryer model:

AF3 - Three (3) drying fan Autoflow.

AF2 - Two (2) drying fan Autoflow.

AF1 - Single drying fan Autoflow.

AB3 - Three (3) drying fan Autobatch.

AB2 - Two (2) drying fan Autobatch.

AB1 - Single drying fan Autobatch.

SELECT TEMP SCALE - Use the increase and decrease to select Fahrenheit or Celsius.

MODEM INIT STRING - Not used. Press the Enter button to return to the main drying screen.

BURNER DIFFENTIAL - Use the Increase and Decrease buttons to change temperature difference between high-fire and low-fire. Recommended setting 3°C.

Help

Currently not used.

Plenum

Set target plenum temperature.

Grain

Set target grain temperature with Increase/Decrease buttons.

Screens

By pressing the Screens button, you can toggle between two (2) screens. Screen #1 displays the current plenum and grain temperatures and their set points in parenthesis. Screen #2 displays the status of the Drying Chamber Rotary switches and the total number of batches. In all screens the dry time and dump time are displayed at the bottom of the screen.

11. Fill System Control Box

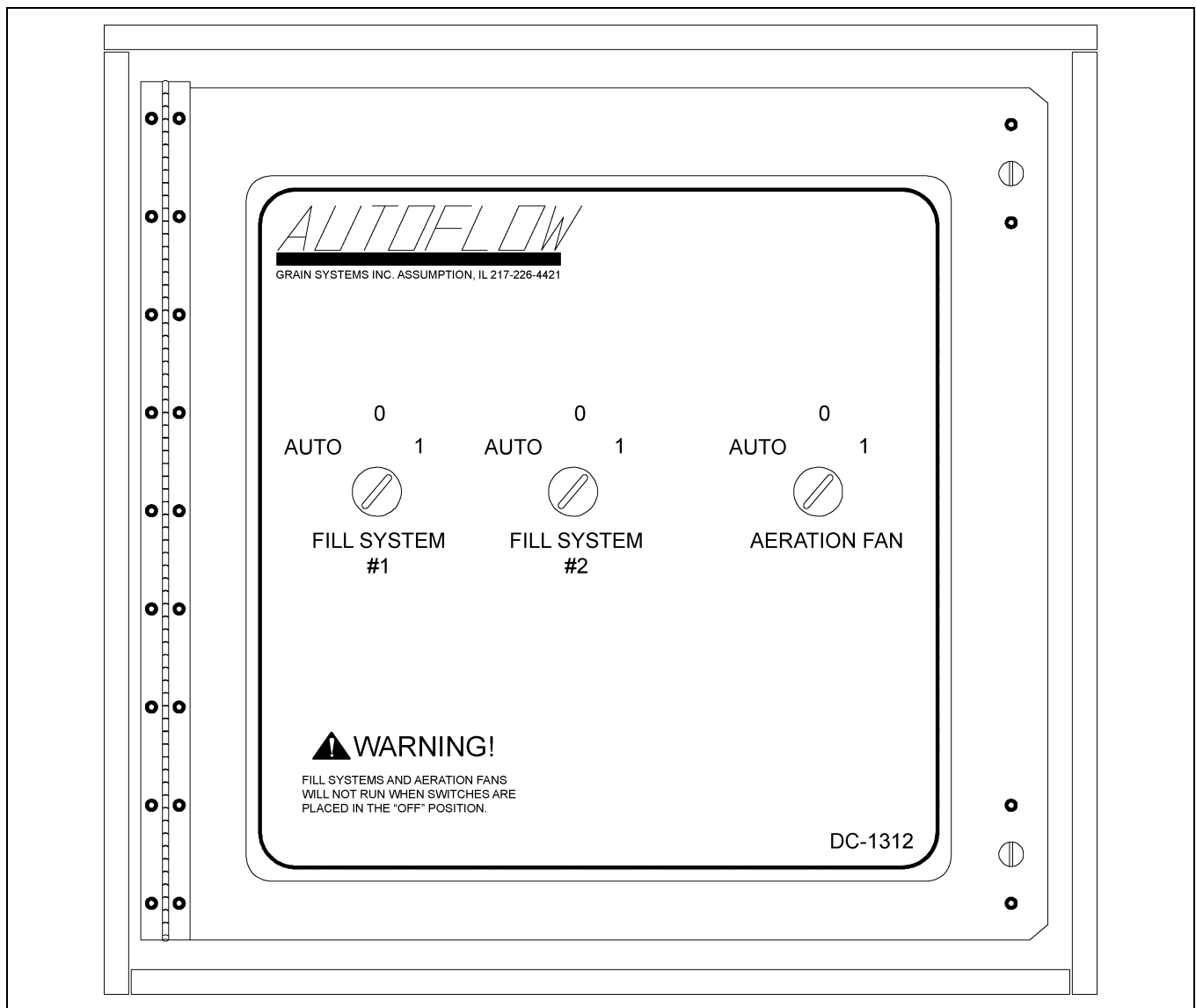

Figure 11A

The fill system control box houses the motor starters for fill system #1, fill system #2 and the aeration fan. Switches are located on the front of the fill system control box and an Emergency Stop switch is located on the side of the control box.

Fill system #1 and fill system #2:

0 = OFF

1 = Manual ON

AUTO = Operates under dryer control

Aeration fan:

0 = OFF

1 = Manual ON

AUTO = Operates under dryer control

Emergency Stop switch:

This switch will stop the dryer when pushed and should be used in case of emergency.

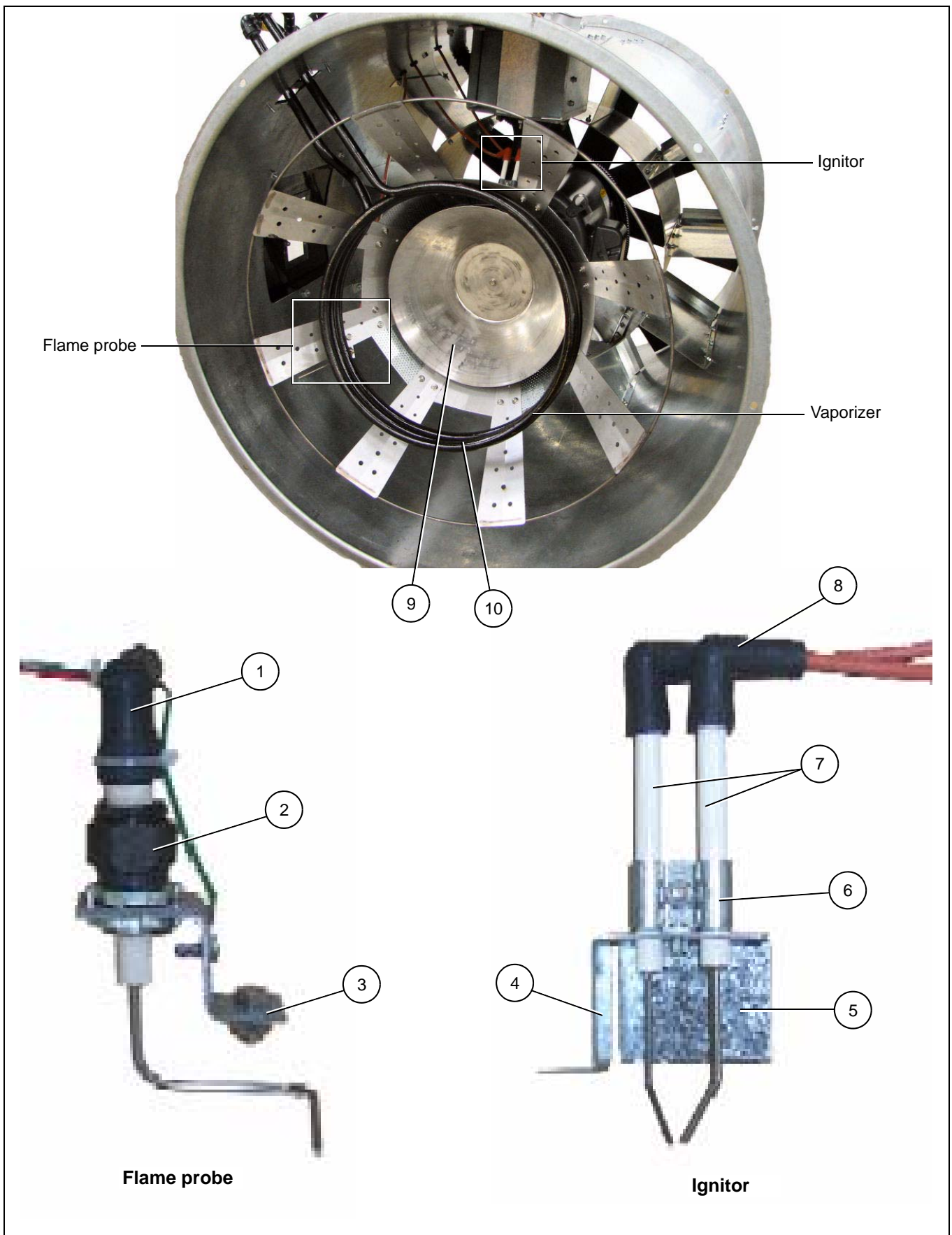

Figure 11B Ignitor and Flame Probe Assemblies

11. Fill System Control Box

Flame Probe, Ignitor and Burner Assemblies Parts List

Ref #	Description
1-3	Flame Probe Assembly Network
1	Boot 8 mm Silicone 90°
2	Flame Sensor 6" Long Rod
3	Flame Sensor Bracket
4-8	Ignitor Assembly
4	Dual Probe Ignitor Bracket
5	Ignitor Air Deflector Angle
6	Ignitor Half Clamp
7	Ignitor Flame
8	Ignition Wire Assembly (Includes Both Wires)
9	Cone
10	Vaporizer Coil

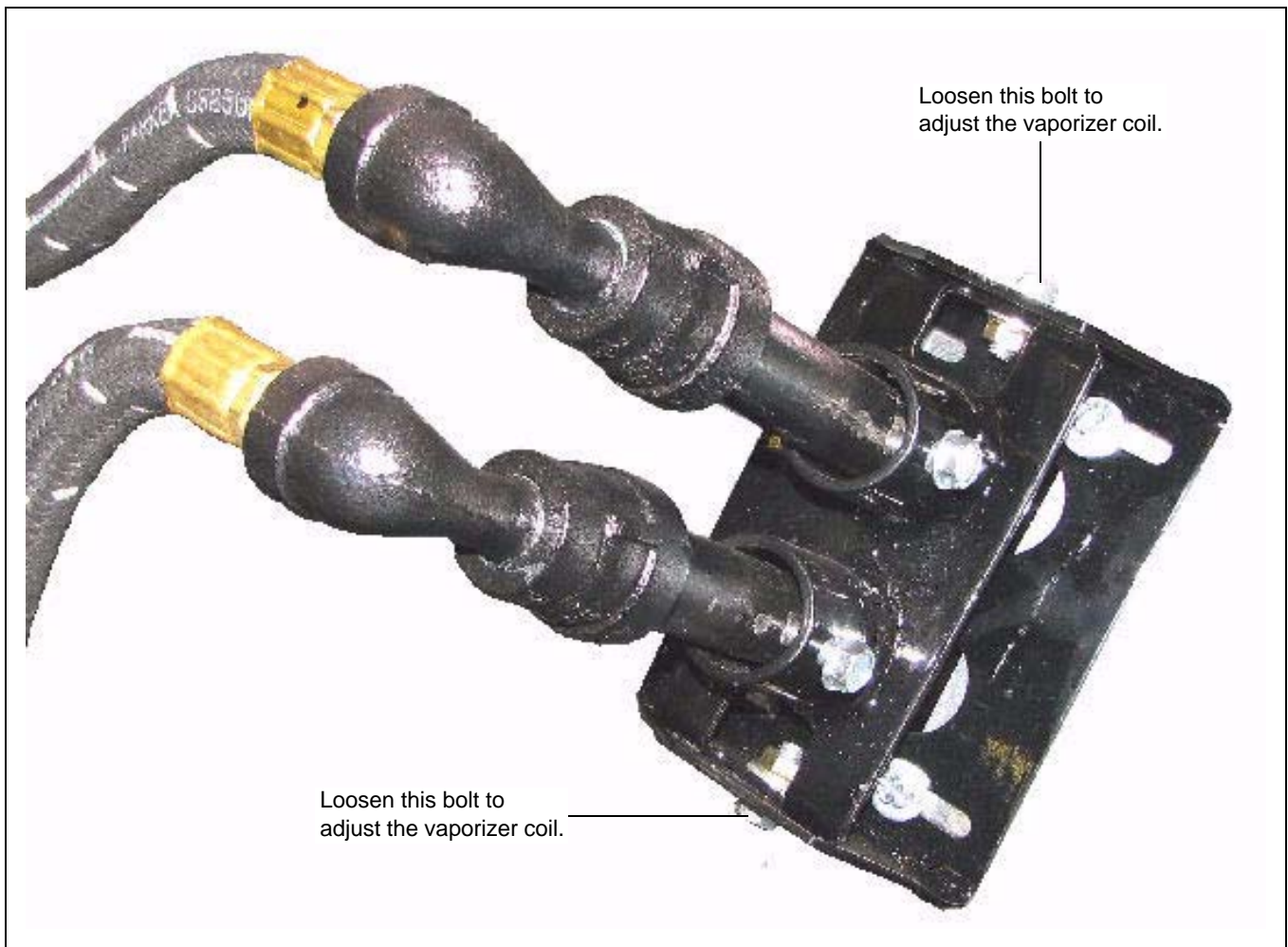

Figure 11C LP Vaporizer Coil Adjustment

Error Messages

Burner * Loss Flame

The flame sensor in burner number * has failed to detect flame. Possible causes:

Burner failed to light.

1. Check fuel supply and pressure.
2. Check spark.
3. Check all solenoid valves are opening.

Flame sensor needs adjusting.

1. It must be in the flame.
2. It can be bent gently if required.

Fan * Vapor High-Limit

The LP gas vapor temperature has exceeded 109°C causing the high-limit to open. This will reset when cool. The vaporizer must be adjusted to move it further from the flame to prevent this re-occurring.

Fan * Housing High-Limit

The temperature in the fan/heater housing has exceeded 180°F. Housing high-limit must be manually reset.

Plenum High-Limit

The dryer plenum has gone over temperature. The plenum high-limit resets automatically when cooled. The low-fire gas pressure needs to be lowered or the cycle set point on the high-low thermostat needs to be increased if the error is displayed frequently.

NOTE: *Vapor, plenum and housing high-limit errors will cause the burner control to lock out. This can only be reset by pressing the illuminated Reset button on the burner control.*

Fan * Motor Overload

The thermal overload in the control box on fan number one has tripped, indicating an over current condition. The overload must be reset manually.

Fan * Loss of Airflow

The burner control air switch is not sensing adequate airflow to allow the burner to light.

1. Check fan is operating at correct speed.
2. Check for damaged fan blades.
3. Check air inlet is not impeded.
4. Check pressure switch.
5. Adjust pressure switch.

12. Error Messages

Drying Chamber Overflow

The grain level in the drying chamber has reached the Drying Chamber Overflow Rotary switch. Grain will have to be dumped from the drying chamber to the storage chamber before the unit can be re-started. This error indicates that either the drying chamber High Level Rotary switch is faulty or the time on the load delay or Aux. 1 delay needs to be lowered.

Bin Grain High-Limit Full

The grain level in the storage chamber has reached the storage chamber High Level Rotary switch located 1 m below the fan and heater(s). Grain will have to be removed from the storage chamber before the unit can be re-started.

Bin High-Limit Switch Bad

The Storage Chamber High Level switch has failed. Switch must be repaired or replaced.

Out of Grain

The grain in the wet supply tank has fallen below the Wet Supply Rotary switch. If there is grain against the Drying Chamber Low Level Rotary switch the dryer can be re-started by pressing the Stop switch to clear the error and then the Start switch.

Wet Supply Empty Press <Enter> to Dry Remaining Grain

The Start button is pushed and grain is below the Wet Supply Level switch whilst grain remains in the Drying Chamber Low Level Rotary switch. If the Enter button is pushed the dryer will re-start, but the fill system(s) will not re-start.

Cannot Start Dryer Wet Supply Empty

The Start button is pushed and grain below the Wet Supply Level switch and there is no grain in the drying chamber.

Dry Chamber Empty

The grain is below the drying chamber low level switch and the Aux. 1 timer has reached zero. If the error is being caused due to the settling of grain after the fans start the time on the Aux. 1 timer can be lengthened.

Fill * Motor Overload

The thermal overload for fill system number * has tripped, indicating an over current condition. The overload must be reset manually.

Aeration Overload

The thermal overload for the aeration fan has tripped, indicating an over current condition. The overload must be reset manually.

Grain High-Limit

The grain temperature in the drying chamber is too high.

High Gas Pressure Switch

In addition to the high pressure relief, the main solenoid valve is fitted with a High Pressure switch. This will cause the burner to shut down if the pressure exceeds the pre-set level.

13. Initial Start-Up

Dryer Commissioning

Electrical

1. Voltage at phases must be within 5% of rated voltage.
2. Voltage drop must not exceed 5% when under full load.
3. Check overload settings for each motor circuit.

Gas Train

1. Pressure test.
 - Close inlet valve.
 - Close firing valve.
 - Fit pressure test nipple into main solenoid inlet flange.
 - Attach hand bellows and pressure gauge.
 - Pressurise gas train with air to 5 PSI.
 - Check for pressure loss at gauge.
 - Use leak detection to test for leaks.
2. Set inlet pressure.
3. Set relief valve to open at 25 PSI.
 - Apply air pressure via main solenoid inlet flange.
 - Increase/decrease spring pressure in relief valve.
 - Valve should open at 25 PSI maximum.
4. Set burner high fire pressure.
 - Note required high fire pressure from burner label.
 - Set plenum temperature to approx. 200°F above ambient.
 - Light burners.
 - Check high-low valve is fully open.
 - Read pressure at burner gauge.
 - Adjust pressure a regulator to give required pressure.
 - Lock regulator.

Gas Train (Continued)

5. Set burner low-fire pressure.
 - Set plenum temperature to approx. 50°F above ambient.
 - Light burners.
 - On low fire, adjust high-low valve minimum setting to give pressure as per burner label.
6. Read pressure at burner gauge.
7. Run burners and check burner modulates correctly.
8. Check gas pressure remains stable fill out gas train commissioning check sheet.

14. Pre-Season Checks

Before the dryer is filled, inspect the unit and check the operation of the dryer as follows. Never enter a bin where grain is present.

Set Control Switches

- Moisture Control switch - "ON"
- Aeration Fan switch - "OFF"
- Load Auger switch - "OFF"
- Fan switch - "OFF"
- Heater switch - "OFF"
- Dump switch - "AUTO"
- Dry and Hold switch - "OFF"
- Autoflow Emergency Stop switch - "OUT"
- Actuator switch - "ON"
- Fill System Control Box Emergency Stop switch - "OUT"

Control Power Switch

Turn the control power switch ON. The switch will illuminate. If a fault is found an error message will be displayed on the screen. If all are found safe, the main drying screen will be displayed.

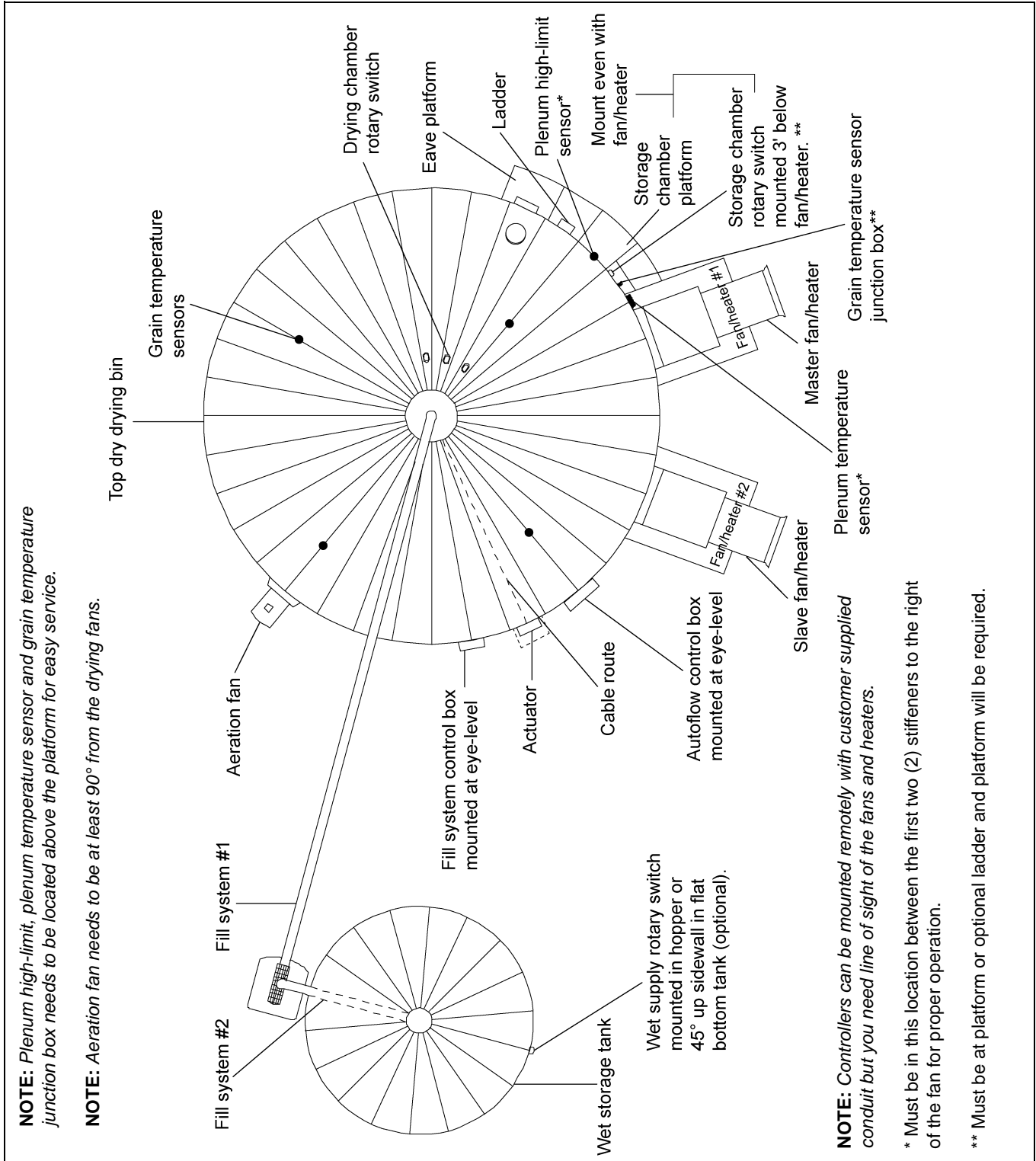

Figure 14A Component Placement

14. Pre-Season Checks

Drying Chamber

Inspect each dump hopper for obstructions.

Make sure that the gap between the discharge flow plates and the floor sheets is a minimum of 1-1/2".

Rotary Switches

Check all rotary switches are spinning freely.

Power Start Button

Ensure there is grain in the wet supply tank.

Push the dryer Start button. The screen should no longer flash "STOPPED".

Fuel Check

Check for leaks as described previously.

Fan

Check fan rotates freely and in the correct direction. If required reverse the fan by swapping over phases L1 and L3.

Make sure the fan runs smoothly with no vibration.

Aeration Fan

Check fan rotates freely and in the correct direction. If required reverse the fan by swapping over phases L1 and L3.

Make sure the fan runs smoothly with no vibration.

Fill System

Prepare the wet storage tank to deliver grain to the dryer.

Make sure all personnel clear.

Switch load auger to “AUTO”.

Grain should be delivered from the wet supply tank to the dryer.

When the display shows “GRAIN LOW LEVEL YES” close the valve that supplies the fill system(s) with wet grain from the wet supply tank.

When the load auger empties turn it “OFF”.

Air Switch

With the drying fan running, adjust the air switch so that it just stops sensing airflow, then increase the air switch sensitivity by 1 full turn.



Figure 14B *Air Switch Adjustment*

Repeat on the slave unit for 2 fan dryers.

Burner Test Fire

Check burner operation and high-low firing rates as per [on Page 52](#).

Note, the burner control runs a fixed purge period of 35 seconds before the burner lights.

Dryer Shut Down

For long term shut down, allow the burner to burn out by shutting off the fuel whilst burning.

Press Stop.

Emergency

In case of an emergency, push the Emergency Stop switch located on the side of the Autoflow control box and the fill system control box.

Internal (Seat) Leakage Testing for Safety Shut Off Valves

NOTE: These instructions were adapted from ASCO valve installation and maintenance instructions and are used with permission. Please refer to the specific installation and maintenance instructions for your specific ASCO valve model for additional details.

1. Shut off both the upstream and downstream manual shut off valves. The downstream manual shut off valve should remain closed during the entire test procedure.
2. Operate the safety shut off valve(s) through five (5) cycles. Listen carefully for the solenoid coil to click indicating proper operation.
3. Open the upstream manual shut off valve. Program the control system to energize and maintain the valve in the open (energized) position. Check all valve and piping connections for external leaks with a rich soap and water solution.
4. Shut off the upstream manual shut off valve and de-energize the safety shut off valve (A). Remove the plug from the leak test tap (B) or downstream pressure tap (F) in the valve body. Connect leak test equipment with the test petcock (G) in the closed position. (See Figure 15A.)

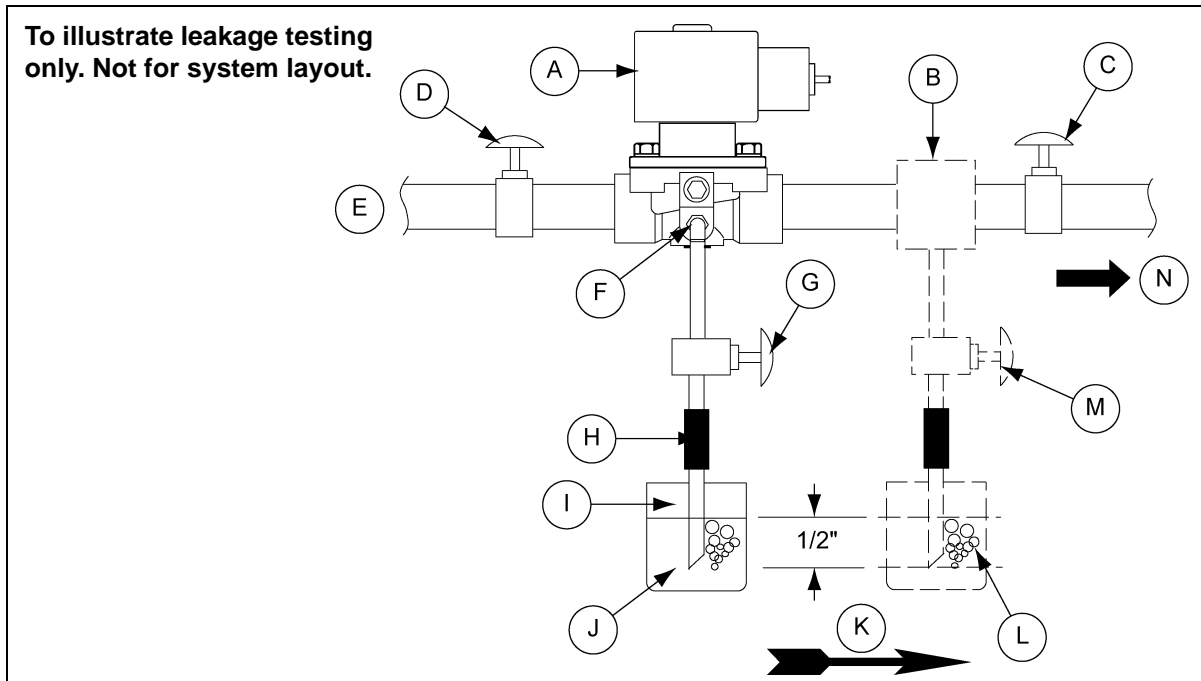

Figure 15A Testing for Internal Seat Leakage

Ref #	Description
A	Safety Shut Off Valve
B	Leak Test Tap
C	Downstream Manual Gas Cock
D	Upstream Manual Gas Cock
E	Gas Supply
F	Downstream Pressure Tap
G	Test Petcock

Ref #	Description
H	1/4" Flex Tubing
I	1/4" Aluminum or Copper Pilot Tubing
J	45° Cut
K	Flow
L	Glass Jar Filled with Water
M	External Leak Text Tap Option
N	To Burner

Internal (Seat) Leakage Testing for Safety Shut Off Valves (Continued)



Some gas will be released to the atmosphere when the pipe plug is removed.

5. Open the upstream manual shut off valve. Program the control system to energize the valve to the full open position, the immediately de-energize it to seat the valve operationally.
6. Immerse the 1/4" leak test tubing vertically into a jar of water to a depth of about 1/2". Slowly open the test petcock (G). Bubbles may appear in the water as the pressure equalizes.
7. After the rate of bubbles coming through the water stabilizes, count the number of bubbles appearing in a 10 seconds period. The allowable leakage in 10 seconds for an orifice diameter of 1" (25.4 mm) or less is six (6) bubbles (3 cc/min). If leakage exceeds this rate, please replace valve.

NOTE: *The leakage rate above recognizes that some wear and contamination from use can result in a slight amount of leakage. The allowable leakage rate is well within the leakage limits as recognized by applicable approval agencies.*

8. Close the upstream manual shut off valve and the test petcock (G). Then remove the test equipment. Apply a small amount of Loctite Corporation's PST Pipe Sealant 567 (or equivalent) to the pipe plug threads. Re-install the pipe plug and tighten securely.



Some gas will be released to the atmosphere when the test equipment is removed.

9. Turn ON the gas supply (E) at the upstream manual shut off valve and energize the safety shut off valve.
10. Open the upstream manual shut off valve. Program the control system to energize and maintain the valve in the open (energized) position. Check the 1/8" NPT pipe plug connection for external leaks with a rich soap and water solution.
11. De-energize the valve. Open the downstream manual gas shut off valve.
12. Restore the system to normal operation.

TopDry Autoflow Theory of Operation

Control Panel Switch Status

- Control power: “ON”
- Moisture control thermostat: “ON”
- Aeration fan: “AUTO”
- Load auger: “AUTO”
- Fan: “AUTO”
- Heater: “AUTO”
- Dump: “AUTO”
- Dry and hold: “OFF”

Emergency Stop Switch Status

- Autoflow control box emergency stop: “pulled out”
- Fill system control box emergency stop: “pulled out”
- Actuator control box 24V switch: “ON”
- Aeration fan bypass: “enabled”

With no grain in the drying chamber and wet grain in the wet storage tank, fill system #1 and fill system #2 (if fitted) will start.

When grain reaches the Drying Chamber Low Level switch, the aeration fan and the master drying fan will start.

After the fan delay time the slave drying fan (if fitted) will start, the air switch will close and the dry timer will start to count down.

After a 20 seconds purge delay, the fan/heater unit(s) will ignite.

When the plenum temperature reaches the cycle set point, the fan/heater unit(s) will cycle to low-fire.

The fan/heater units will continue to cycle throughout the drying process.

When grain reaches the Chamber High Level switch, the fill #2 delay will begin to count down.

When the fill #2 delay reaches zero, fill system #2 will shut off and the fill #1 delay will begin to count down.

When the fill #1 delay reaches zero fill system #1 will shut off.

If the grain drops below the High Level switch, the fill system(s) will start and refill the drying chamber.

When the dry timer reaches zero, if the grain temperature is below set point, the dryer will go into temperature hold.

When the grain temperature reaches set point, the unit will continue to the dump cycle.

In the dump cycle, the grain is dumped into the storage chamber.

When the dump timer reaches zero, the dump chutes raise.

During the dump cycle 1/3 of the grain is dumped into the storage chamber.

After the dump cycle, the unit returns to the beginning of the dry cycle, the fill system(s) refill the drying chamber and the process begins again.

The unit continues with the same operation until either no grain is present against the Wet Supply Rotary switch or the storage chamber becomes full.

If the wet storage tank becomes empty, the fill #1 and fill #2 delays starts to count down.

When the delays reach zero, the fill system(s) and dryer shut off.

Wet supply hopper empty “out of grain” error is displayed. If there is grain above the Drying Chamber Low Level switch, the unit can be re-started by pressing the Start switch.

When the Start switch is pressed, the screen on the dryer control panel will read “press enter to dry remaining grain”. If the Enter button is pushed the dryer will re-start without running the fill system(s). The dryer will remain running until the completion of the next dump cycle, after which an “out of grain” error is displayed on the dryer control panel and the dryer stops.

If the storage chamber reaches full during the dump cycle, the dryer will continue through the dump cycle and will continue to the next dry cycle.

When the dry cycle is complete, the unit will not continue to the dump cycle. A “bin grain high-limit” error will be displayed on the screen and the dryer will stop.

If the dryer stops for any reason, the aeration fan will remain running if the aeration fan bypass is enabled.

17. Start-Up Procedure

Initial Dryer Start-Up

1. With Control Power switch OFF, turn ON the main power supply.
2. Pull out all Emergency Stop switches.
3. Set the switches as follows:
 - Moisture Control switch - “ON”
 - Aeration Fan switch - “AUTO”
 - Load Auger switch - “OFF”
 - Fan switch - “AUTO”
 - Heater switch - “AUTO”
 - Dump switch - “AUTO”
 - Dry and Hold switch - “OFF”
4. Make sure there is wet grain in the wet supply tank.
5. Turn control power “ON” position.
6. The screen will display a copyright message and software version number.
7. The screen should read “STOPPED”. The chamber high level and the chamber low level should both read “NO”.
8. Set the dry timer using the drying charts for the specific bin size, fan and heater size, drying temperature and grain input moisture content.
9. Set the dump timer as follows:
 - 24' Diameter bin = 28 Seconds
 - 30' Diameter bin = 34 Seconds
 - 36' Diameter bin = 31 Seconds
10. Set all other delays and timers as prescribed in the electronic monitoring control section [on Page 43](#) of this manual.
11. Press the Reset button for timer changes to take effect immediately.

12. Set the grain temperature set point as follows:

- 82°C Drying temperature = 38°C Grain temperature set point
- 77°C Drying temperature = 39°C Grain temperature set point
- 71°C Drying temperature = 41°C Grain temperature set point
- 66°C Drying temperature = 42°C Grain temperature set point
- * 60°C Drying temperature = 43°C Grain temperature set point
- * 54°C Drying temperature = 45°C Grain temperature set point
- * 49°C Drying temperature = 46°C Grain temperature set point

* When drying at a temperature lower than 66°C the grain temperature set point on the moisture control thermostat may require a lower setting at night.

13. Press the Start switch on the dryer control panel.



Be sure all personnel are clear of fill systems. Place the Load Auger switch on the dryer control panel to the "AUTO" position.

14. The fill system(s) should start immediately.

15. When the grain reaches the Drying Chamber Low Level switch, the fan and heater(s) should start.

16. When the grain reaches the drying chamber, Low Level Rotary switch reaches the Drying Chamber High Level Rotary switch the fill system(s) should stop.

17. When the dry timer reaches zero, the display should read "TEMP HOLD".

18. When the grain temperature reaches the grain temperature set point, the dryer should continue to the dump cycle.

19. The dump chutes should lower, grain should dump from the drying chamber into the storage chamber and the fill system(s) should start.

20. After the dump cycle, the dryer should continue to the beginning of the next dry cycle.

21. After the fourth dump, stop the dryer.

22. Test the moisture of the dried grain.

23. If the moisture of the grain is too high, increase the grain temperature set point 2.5°C for each additional point of moisture to be removed.

24. If the moisture of the grain is too low, decrease the grain temperature set point 2.5°C for each additional point of moisture to be added.

25. After the moisture control thermostat is adjusted, decrease the time on the dry timer by one-half. The dry timer should not be set lower than the amount of time it takes the dryer to refill after the dump cycle.

26. Re-start the dryer. The time on the dry timer should expire before the grain reaches the temperature set point.

27. Any time a change is made to the grain temperature set point, the dryer must dump four (4) times before the full effect of the change will be made on the moisture of the grain.

17. Start-Up Procedure

Normal Start-Up

When the dryer is started with grain in the drying chamber that has already been partially dried, the dryer can be started without making any adjustments to time or temperature; however, the moisture of the grain should be checked after the fourth dump.

Last Fill

1. Stop the dryer when all the wet grain has been loaded into the drying chamber and turn OFF the Moisture Control switch.
2. Set the time on the dry timer for twice the recommended amount using the charts for the specific bin size, fan and heater size, drying temperature and grain input moisture content.
3. Push the Reset button.
4. Turn the Dry and Hold switch to the "ON" position.
5. Turn the Load Auger switch to the "OFF" position.
6. Press the Start switch.
7. When the dryer shuts down install the fan inlet cover(s).
8. Let the aeration fan cool in the top and store or manually dump into the storage chamber.

GSI Group, LLC Limited Warranty

The GSI Group, LLC ("GSI") warrants products which it manufactures to be free of defects in materials and workmanship under normal usage and conditions for a period of 12 months after sale to the original end-user or if a foreign sale, 14 months from arrival at port of discharge, whichever is earlier. The end-user's sole remedy (and GSI's only obligation) is to repair or replace, at GSI's option and expense, products that in GSI's judgment, contain a material defect in materials or workmanship. Expenses incurred by or on behalf of the end-user without prior written authorization from the GSI Warranty Group shall be the sole responsibility of the end-user.

Warranty Extensions:

The Limited Warranty period is extended for the following products:

	Product	Warranty Period	
AP Fans and Flooring	Performer Series Direct Drive Fan Motor	3 Years	* Warranty prorated from list price: 0 to 3 years - no cost to end-user 3 to 5 years - end-user pays 25% 5 to 7 years - end-user pays 50% 7 to 10 years - end-user pays 75%
	All Fiberglass Housings	Lifetime	
	All Fiberglass Propellers	Lifetime	
AP and Cumberland	Flex-Flo/Pan Feeding System Motors	2 Years	
Cumberland Feeding/Watering Systems	Feeder System Pan Assemblies	5 Years **	** Warranty prorated from list price: 0 to 3 years - no cost to end-user 3 to 5 years - end-user pays 50%
	Feed Tubes (1-3/4" and 2.00")	10 Years *	
	Centerless Augers	10 Years *	
	Watering Nipples	10 Years *	
Grain Systems	Grain Bin Structural Design	5 Years	
Grain Systems Farm Fans Zimmerman	Portable and Tower Dryers	2 Years	† Motors, burner components and moving parts not included. Portable dryer screens included. Tower dryer screens not included.
	Portable and Tower Dryer Frames and Internal Infrastructure †	5 Years	

GSI further warrants that the portable and tower dryer frame and basket, excluding all auger and auger drive components, shall be free from defects in materials for a period of time beginning on the twelfth (12th) month from the date of purchase and continuing until the sixtieth (60th) month from the date of purchase (extended warranty period). During the extended warranty period, GSI will replace the frame or basket components that prove to be defective under normal conditions of use without charge, excluding the labor, transportation, and/or shipping costs incurred in the performance of this extended warranty.

Conditions and Limitations:

THERE ARE NO WARRANTIES THAT EXTEND BEYOND THE LIMITED WARRANTY DESCRIPTION SET FORTH ABOVE. SPECIFICALLY, GSI MAKES NO FURTHER WARRANTY OF ANY KIND, EXPRESS OR IMPLIED, INCLUDING, WITHOUT LIMITATION, WARRANTIES OF MERCHANTABILITY OR FITNESS FOR A PARTICULAR PURPOSE OR USE IN CONNECTION WITH: (I) PRODUCT MANUFACTURED OR SOLD BY GSI OR (II) ANY ADVICE, INSTRUCTION, RECOMMENDATION OR SUGGESTION PROVIDED BY AN AGENT, REPRESENTATIVE OR EMPLOYEE OF GSI REGARDING OR RELATED TO THE CONFIGURATION, INSTALLATION, LAYOUT, SUITABILITY FOR A PARTICULAR PURPOSE, OR DESIGN OF SUCH PRODUCTS.

GSI shall not be liable for any direct, indirect, incidental or consequential damages, including, without limitation, loss of anticipated profits or benefits. The sole and exclusive remedy is set forth in the Limited Warranty, which shall not exceed the amount paid for the product purchased. This warranty is not transferable and applies only to the original end-user. GSI shall have no obligation or responsibility for any representations or warranties made by or on behalf of any dealer, agent or distributor.

GSI assumes no responsibility for claims resulting from construction defects or unauthorized modifications to products which it manufactured. Modifications to products not specifically delineated in the manual accompanying the equipment at initial sale will void the Limited Warranty.

This Limited Warranty shall not extend to products or parts which have been damaged by negligent use, misuse, alteration, accident or which have been improperly/inadequately maintained. This Limited Warranty extends solely to products manufactured by GSI.

Prior to installation, the end-user has the responsibility to comply with federal, state and local codes which apply to the location and installation of products manufactured or sold by GSI.

This equipment shall be installed in accordance with the current installation codes and applicable regulations, which should be carefully followed in all cases. Authorities having jurisdiction should be consulted before installations are made.



**1004 E. Illinois St.
Assumption, IL 62510-0020
Phone: 1-217-226-4421
Fax: 1-217-226-4420
www.gsiag.com**



GSI is a worldwide brand of AGCO Corporation.